

**Command Line Interface Volume 1  
User's Guide and Protocol Reference**

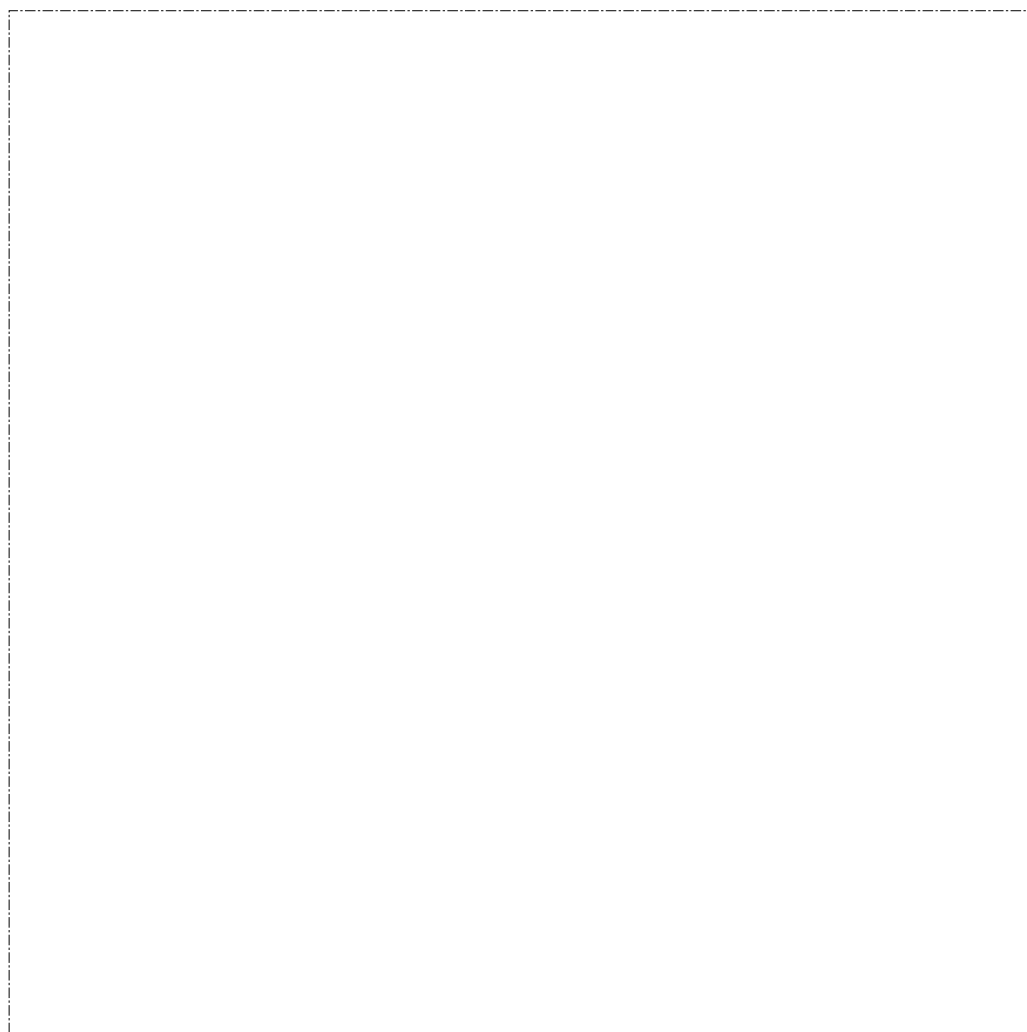





Multiprotocol Switched Services (MSS) Server

SC30-3818-01

**Command Line Interface Volume 1  
User's Guide and Protocol Reference**

**Note**

Before using this document, read the general information under "Notices" on page xvii.

## **Second Edition (January 1997)**

This edition applies to Version 1 Release 1 of the IBM Multiprotocol Switched Services (MSS) Server and to all subsequent releases and modifications until otherwise indicated in new editions or technical newsletters.

Order publications through your IBM representative or the IBM branch office serving your locality. Publications are not stocked at the address below.

IBM welcomes your comments. A form for readers' comments is provided at the back of this publication. If the form has been removed, you may address your comments to:

International Business Machines Corporation  
Design and Information Development  
Department CGF  
P.O. Box 12195  
Research Triangle Park, NC 27709-9990  
U.S.A.

When you send information to IBM, you grant IBM a nonexclusive right to use or distribute the information in any way it believes appropriate without incurring any obligation to you.

© **Copyright International Business Machines Corporation 1996, 1997. All rights reserved.**

Note to U.S. Government Users — Documentation related to restricted rights — Use, duplication or disclosure is subject to restrictions set forth in GSA ADP Schedule Contract with IBM Corp.

---

# Contents

<b>Notices</b> .....	xvii
Trademarks .....	xvii
<b>Preface</b> .....	xix
Conventions Used in This Manual .....	xix
MSS Server Library .....	xx
Summary of Changes For Version 1 Release 1.1 .....	xxi

---

## Part 1. User's Guide

<b>Chapter 1. Getting Started (Introduction to the User Interface)</b> .....	1-1
Before You Begin .....	1-1
Using Local and Remote Router Consoles .....	1-2
Local Consoles .....	1-2
Remote Consoles .....	1-3
Logging In Remotely or Locally .....	1-3
Discussing the User Interface System .....	1-7
Definition of the First-Level User Interface .....	1-10
Accessing Protocol Configuration and Console Processes .....	1-11
Accessing the Protocol Configuration Process (CONFIG) .....	1-11
Accessing the Protocol Console (Monitoring) Process, GWCON .....	1-13
Accessing Feature Configuration and Console Processes .....	1-15
Accessing the Feature Processes .....	1-16
Accessing Network Interface Configuration and Console Processes .....	1-16
Accessing the Network Interface Configuration Process .....	1-16
Accessing the Network Interface Console Process .....	1-18
Command History for GWCON and CONFIG Command Line .....	1-20
Repeating a Command in the Command History .....	1-20
Repeating a Series of Commands in the Command History .....	1-21
System Security .....	1-23
<b>Chapter 2. Getting Started with the Configuration of the MSS Server</b> ..	2-1
Physical Access Methods .....	2-1
SLIP Addresses .....	2-3
Serial Port and Data/Fax Modem Default Settings .....	2-3
Configuration and Monitoring Tools .....	2-3
Fax Accumulation .....	2-5
Local and Remote Console Access .....	2-5
Remote Voice Access .....	2-5
File Transfer .....	2-5
Initial Configuration .....	2-6
First Example .....	2-6
Second Example .....	2-6
Tips for Managing Configuration Problems .....	2-7
Reconfiguring .....	2-7
Quick Configuration .....	2-7
Completing the Configuration After Quick Configuration .....	2-7
How Software Files Are Managed .....	2-8
How to View the Files .....	2-8

How to Reset the MSS Server	2-8
File Transfer Using TFTP	2-9
Storing Configuration Files Using the Command Line Interface or the Web Browser Interface	2-9
Changing the Statuses of Files	2-9
Using the Configuration Program to Manage the Configuration Files	2-10
Using the Set Commands	2-10
Other Change Management Functions	2-10
Using the Copy Command	2-11
Using the Lock Command	2-11
Using the Unlock Command	2-12
Brief Overview of the Functions of the MSS Server	2-12
<b>Chapter 3. Using the World Wide Web Interface</b>	3-1
Connecting to the World Wide Web Interface	3-1
Rules for Using the Web Interface	3-1
Home Page Structure	3-2
Configuration and Console Menu	3-3
Event Logging System	3-4
Operator Console	3-4
Router Configuration	3-4
History Function	3-5
Help System for the Web Browser Interface	3-5
Quick Configuration Using the Web Browser Interface	3-5
Guided Configuration	3-6
Devices	3-6
LAN Emulation	3-6
Bridging	3-7
IP	3-7
IPX	3-8
An Example of Quick Configuration Using the Web Browser Interface	3-8
<b>Chapter 4. MSS Server Voice/Data/Fax Modem Support</b>	4-1
Installation of the Voice/Data/Fax Modem	4-1
Data/Fax Modem	4-1
MSS Server Voice Access Using the Voice/Data/Fax Modem	4-1
Performance Information	4-2
Remote Service	4-2
Network Monitoring	4-2
Configuration	4-2
MSS Server Voice Pager Support	4-2
Voice Pager Configuration Parameters	4-3
Voice Pager Messages	4-4
Maintenance Log	4-4
Maintenance Log Configuration Parameter	4-4
Voice/Data/Fax Modem Menu Items	4-4
Option 1—Reset	4-5
Option 2—Status and Statistics	4-5
Option 3—Reports	4-6
Option 4—Event Logs	4-7
Option 5—Configuration	4-7
Option 6—Device Presence and Status Report	4-7
Option 7—Resend Last Fax Report	4-8
Option 8—Disconnect Call	4-8

Option 9—Repeat Menu . . . . .	4-8
<b>Chapter 5. The OPCON Process and Commands . . . . .</b>	<b>5-1</b>
What is OPCON? . . . . .	5-1
Accessing the OPCON Process . . . . .	5-2
OPCON Commands . . . . .	5-3
? (Help) . . . . .	5-4
Diags . . . . .	5-4
Divert . . . . .	5-5
Flush . . . . .	5-5
Halt . . . . .	5-6
Intercept . . . . .	5-6
Logout . . . . .	5-7
Memory . . . . .	5-7
Reload . . . . .	5-8
Status . . . . .	5-8
Talk . . . . .	5-9
Telnet . . . . .	5-9
<b>Chapter 6. The CONFIG Process and Commands . . . . .</b>	<b>6-1</b>
What is CONFIG? . . . . .	6-1
CONFIG-Only Mode . . . . .	6-2
Automatic Entry Into Config-Only Mode . . . . .	6-2
Manual Entry Into Config-Only Mode . . . . .	6-3
Quick Configuration . . . . .	6-3
Manual Entry Into the Quick Config Mode . . . . .	6-4
Exiting from Quick Config Mode . . . . .	6-4
Configuring User Access . . . . .	6-5
Technical Support Access . . . . .	6-5
Entering and Exiting CONFIG . . . . .	6-6
Entering the Desired Protocol Configuration Process . . . . .	6-6
CONFIG Commands . . . . .	6-7
? (Help) . . . . .	6-7
Add . . . . .	6-8
Boot . . . . .	6-9
Change . . . . .	6-9
Clear . . . . .	6-12
Delete . . . . .	6-13
Disable . . . . .	6-14
Enable . . . . .	6-14
Event . . . . .	6-15
Feature . . . . .	6-15
System Memory Dump . . . . .	6-16
List . . . . .	6-17
Network . . . . .	6-18
Patch . . . . .	6-19
Protocol . . . . .	6-20
Qconfig . . . . .	6-21
Set . . . . .	6-21
Time . . . . .	6-25
Unpatch . . . . .	6-26
Update . . . . .	6-26
<b>Chapter 7. The Boot/Dump Configuration Process and Commands . . . . .</b>	<b>7-1</b>

Understanding Change Management	7-1
Using the Trivial File Transfer Protocol (TFTP)	7-1
Entering and Exiting Change Management Configuration Environment	7-2
Change Management Configuration Commands	7-2
? (Help)	7-3
Add	7-4
COPY	7-5
DESCRIBE command	7-6
ERASE command	7-7
LIST	7-9
LOCK	7-10
SET command	7-11
TFTP command	7-12
UNLOCK	7-12
Exit	7-13
<b>Chapter 8. Accessing the Firmware from the Command Line Interface</b>	8-1
Accessing the Firmware Prompt	8-1
Boot Options Available for the 8210	8-1
Attended Mode	8-2
Unattended Mode	8-2
<b>Chapter 9. The GWCON (Monitoring) Process and Commands</b>	9-1
What is GWCON?	9-1
Entering and Exiting GWCON	9-2
GWCON Commands	9-2
? (Help)	9-3
Buffer	9-3
Clear	9-4
Configuration	9-4
Disable	9-6
Environment	9-7
Error	9-8
Event	9-8
Feature	9-8
Interface	9-9
Memory	9-10
Network	9-11
Protocol	9-12
Queue	9-13
Statistics	9-14
Test	9-14
<b>Chapter 10. The MONITR Process</b>	10-1
What is MONITR?	10-1
Commands Affecting MONITR	10-2
Entering and Exiting MONITR	10-2
Receiving MONITR Messages	10-2
<b>Chapter 11. Using and Configuring the Event Logging System (ELS)</b>	11-1
What is ELS?	11-1
Entering and Exiting the ELS Configuration Environment	11-2
ELS Configuration Environment	11-3
Event Logging Concepts	11-3



Causes of Events	11-3
Interpreting a Message	11-3
ELS Configuration Commands	11-7
? (Help)	11-7
Add	11-8
Clear	11-8
Default	11-8
Delete	11-8
Display	11-9
List	11-11
Nodisplay	11-12
Notrace	11-13
Notrap	11-13
Set	11-14
Trace	11-15
Trap	11-15
Exit	11-16
<b>Chapter 12. Monitoring the Event Logging System (ELS)</b>	12-1
Using ELS	12-1
Managing ELS Message Rotation	12-1
Capturing ELS Output Using a Telnet Connection on a UNIX Host	12-2
Configuring ELS So Event Messages Are Sent In SNMP Traps	12-2
Using ELS to Troubleshoot a Problem	12-3
ELS Example 1	12-3
ELS Example 2	12-3
ELS Example 3	12-4
Entering and Exiting the ELS Console Environment	12-5
ELS Console Commands	12-6
? (Help)	12-6
Clear	12-7
Display	12-7
Files	12-8
List	12-8
Nodisplay	12-10
Notrace	12-11
Notrap	12-11
Remove	12-11
Restore	12-11
Retrieve	12-11
Save	12-12
Set	12-12
Statistics	12-13
Trace	12-14
Trap	12-15
View	12-15
Exit	12-16
<b>Chapter 13. Using, Configuring and Monitoring FDDI</b>	13-1
Fiber Distributed Data Interface (FDDI) Overview	13-1
Token-Passing Ring Network	13-1
Primary and Secondary Rings	13-2
Attachment of Devices	13-2
Differences Between FDDI and Token-Ring	13-2

Device Classes A and B	13-2
FDDI Network Diagram	13-3
Accessing the FDDI Configuration Process	13-4
FDDI Configuration Commands	13-4
? (Help)	13-4
Frame	13-5
List	13-5
Set	13-6
Exit	13-7
Accessing the FDDI Console Process	13-7
FDDI Console Commands	13-7
? (Help)	13-7
List	13-8
Exit	13-8
<b>Chapter 14. Using and Configuring MAC Filtering</b>	14-1
MAC Filtering Parameters	14-1
Sliding-Window Filter Parameters	14-1
Address Filter-Item Parameters	14-2
Filter-List Parameters	14-2
Filter Parameters	14-2
Using MAC Filtering Tags	14-3
Accessing the MAC Filtering Configuration Prompt	14-3
MAC Filtering Configuration Commands	14-4
? (Help)	14-5
Attach	14-5
Create	14-5
Default	14-5
Delete	14-6
Detach	14-6
Disable	14-6
Enable	14-7
List	14-7
Move	14-8
Reinit	14-8
Set-Cache	14-8
Update	14-8
Exit	14-8
Update Subcommands	14-9
? (Help)	14-9
Add	14-9
Delete	14-10
List	14-11
Move	14-12
Set-Action	14-12
Exit	14-12
<b>Chapter 15. Monitoring MAC Filtering</b>	15-1
Accessing the MAC Filtering Console Prompt	15-1
MAC Filtering Console Commands	15-1
? (Help)	15-2
Clear	15-2
Disable	15-2
Enable	15-2

List	15-3
Reinit	15-3
Exit	15-4
<b>Chapter 16. Using and Configuring Quality of Service (QoS)</b>	16-1
Quality of Service (QoS) Overview	16-1
Benefits of QoS	16-1
QoS Configuration Parameters	16-2
Accessing the QoS Configuration Prompt	16-6
Quality of Service (QoS) Commands	16-7
LE Client QoS Configuration Commands	16-7
? (Help)	16-8
List	16-8
Set	16-8
Remove	16-11
Exit	16-11
ATM Interface QoS Configuration Commands	16-12
List	16-12
Set	16-12
Remove	16-14
Exit	16-14
<b>Chapter 17. Monitoring Quality of Service (QoS)</b>	17-1
Accessing the QoS Console Commands	17-1
Quality of Service (QoS) Console Commands	17-1
LE Client QoS Console Commands	17-2
? (Help)	17-2
List	17-2
Exit	17-6

---

## Part 2. ATM and LAN Emulation

<b>Chapter 18. Overview of LAN Emulation</b>	18-1
LAN Emulation Benefits	18-1
LAN Emulation Components	18-2
Addressing in ATM	18-3
ESI	18-4
ATM Addresses of LAN Emulation Components	18-4
Overview of Related ILMI Functions	18-5
Manual Configuration of the Signaling Version	18-5
Locating the LECS Using ILMI	18-5
Overview of the LECS Function	18-6
Sample Situations for Use of the LECS Assignment Policies	18-8
More Information About TLVs	18-10
Connecting to the LES	18-10
Address Registration	18-11
Address Resolution	18-11
Connecting to the BUS	18-11
BUS Functions	18-12
Establishing Data Direct VCCs	18-13
Overview of server Extensions for LAN Emulation	18-13
Broadcast Manager (BCM)	18-14
BCM Support for IP	18-14

BCM Support for IPX . . . . .	18-14
BCM Support for NetBIOS . . . . .	18-15
BCM Support for Source Route Bridging . . . . .	18-15
LAN Emulation Reliability . . . . .	18-15
LAN Emulation Security . . . . .	18-17
BUS Monitor . . . . .	18-18
Key Configuration Parameters for LAN Emulation . . . . .	18-18
Super ELANs . . . . .	18-19
Bridging Broadcast Manager . . . . .	18-20
Dynamic Protocol Filtering (VLANS) . . . . .	18-20
<b>Chapter 19. Using and Configuring ATM . . . . .</b>	<b>19-1</b>
ATM and LAN Emulation . . . . .	19-1
How to Enter Addresses . . . . .	19-1
Accessing the ATM Interface Configuration Process . . . . .	19-2
ATM Configuration Commands . . . . .	19-3
ATM Interface Commands (ATM INTERFACE> Prompt) . . . . .	19-4
Add . . . . .	19-4
List . . . . .	19-4
QoS Configuration . . . . .	19-5
Remove . . . . .	19-5
Set . . . . .	19-5
Enable . . . . .	19-8
Disable . . . . .	19-8
Exit . . . . .	19-9
ATM Virtual Interface Concepts . . . . .	19-9
Advantages of Using ATM Virtual Interfaces . . . . .	19-9
Disadvantages of using ATM Virtual Interfaces . . . . .	19-10
Access to the Virtual ATM Interface Configuration . . . . .	19-11
ATM Virtual Interface Configuration Commands . . . . .	19-11
Help (?) . . . . .	19-12
Add . . . . .	19-12
List . . . . .	19-12
Remove . . . . .	19-12
Exit . . . . .	19-13
<b>Chapter 20. Monitoring ATM . . . . .</b>	<b>20-1</b>
Accessing the ATM Console Commands . . . . .	20-1
ATM Console Commands . . . . .	20-2
Interface . . . . .	20-2
LE-Services . . . . .	20-2
Exit . . . . .	20-2
ATM Interface Console Commands (ATM INTERFACE+ Prompt) . . . . .	20-3
List . . . . .	20-3
Trace . . . . .	20-4
Wrap . . . . .	20-5
Exit . . . . .	20-6
<b>Chapter 21. Using and Configuring LAN Emulation Clients . . . . .</b>	<b>21-1</b>
LAN Emulation Client Overview . . . . .	21-1
Configuring LAN Emulation Clients (LE Client Config>) . . . . .	21-2
Help . . . . .	21-3
Add . . . . .	21-3
Config . . . . .	21-4

List	21-4
Remove	21-4
Exit	21-4
Configuring an ATM Forum-Compliant LE Client	21-5
Help	21-5
Frame	21-5
RIF-Timer (for Token-Ring Forum-compliant LEC only)	21-6
Source-routing (for Token-Ring Forum-compliant LEC only)	21-7
IP-Encapsulation (for Ethernet Forum-compliant LEC only)	21-7
List	21-7
QoS	21-7
Set	21-7
Exit	21-15
Configuring an IBM LE Client	21-15
Help	21-16
Frame	21-16
RIF-Timer (for Token-Ring-IBM LEC only)	21-17
Source-routing (for Token-Ring-IBM LEC only)	21-18
IP-Encapsulation (for Ethernet-IBM LEC only)	21-18
List	21-18
Set	21-18
Exit	21-22
<b>Chapter 22. Monitoring LAN Emulation Clients</b>	22-1
Accessing the LEC Console Environment	22-1
LEC Console Commands	22-2
? (Help)	22-2
List	22-2
MIB	22-5
QoS Information	22-9
Exit	22-9
<b>Chapter 23. Configuring LAN Emulation Services</b>	23-1
About LAN Emulation Services	23-1
Accessing the LAN Emulation Services Environment	23-1
Lecs	23-2
Les-bus	23-2
List	23-3
Rename	23-3
Security	23-3
Exit	23-3
Configuring a LES-BUS	23-4
Add	23-4
Disable	23-5
Enable	23-5
List	23-6
Remove	23-7
Set	23-8
Exit	23-14
Commands for Configuring a LECS	23-15
Add	23-15
Elans	23-15
List	23-16
Policies	23-16

Remove	23-16
Search	23-17
Set	23-17
Exit	23-19
Configuring ELANs at the LECS	23-20
Add	23-20
List	23-21
Remove	23-21
Select	23-21
Exit	23-22
Detailed Configuration of an ELAN at the LECS	23-23
Les	23-23
List	23-26
Policy	23-26
Set	23-28
Tlv	23-29
Exit	23-32
Configuring the Policies of a LECS	23-33
Add	23-33
Disable	23-34
Enable	23-34
List	23-34
Remove	23-35
Exit	23-35
Configuring Security for ELANs	23-36
Add	23-36
Disable	23-36
Enable	23-37
List	23-37
Remove	23-37
Set	23-37
Exit	23-38
<b>Chapter 24. Monitoring LAN Emulation Services</b>	24-1
Accessing the LAN Emulation Services Console Environment	24-2
LAN Emulation Services Console Commands	24-3
Help	24-3
Create	24-3
LECS	24-4
List	24-4
Security	24-4
Work	24-4
Exit	24-5
LES-BUS Console Commands	24-6
Help	24-6
Database	24-7
Delete	24-14
Disable	24-14
Enable	24-15
List	24-16
Restart	24-18
Set	24-18
Statistics	24-20
Stop	24-29

Exit	24-29
LECS Console Commands	24-30
Help	24-30
Create	24-31
Delete	24-31
ELANS	24-31
List	24-31
Memory	24-34
Policies	24-34
Restart	24-34
Search	24-34
Set	24-36
Statistics	24-38
Exit	24-39
LECS Policies Console Commands	24-40
Help	24-40
Create	24-40
Delete	24-41
Elans	24-41
List	24-41
Memory	24-42
Policies	24-42
Restart	24-42
Search databases	24-42
Set databases	24-42
Statistics	24-42
Exit	24-43
Monitoring ELANs at the LECS	24-44
Help	24-44
Create	24-44
Delete	24-45
List	24-45
Select ELAN	24-45
Statistics	24-46
Exit	24-46
Monitoring ELAN Details at the LECS	24-47
Help	24-47
LES	24-47
List	24-50
Policy	24-50
Set	24-52
TLVs	24-52
Exit	24-53
Security for LE Service Console Commands	24-54
Help	24-54
Create	24-55
Delete	24-55
List	24-55
Restart	24-56
Statistics	24-57
Exit	24-57

<b>List of Abbreviations</b>	X-1
------------------------------	-----

<b>Glossary</b> .....	X-5
<b>Index</b> .....	X-29



---

## Figures

1-1.	Talk and the Intercept Commands . . . . .	1-6
1-2.	IBM 8210 Multiprotocol Switched Services Server . . . . .	1-7
2-1.	Local Serial Connection to the EIA 232 Port . . . . .	2-2
2-2.	Remote Serial Connection to the PCMCIA Modem (Voice/Data/Fax Modem or Data/Fax Modem) . . . . .	2-2
2-3.	Connection Using IP Over the ATM Network . . . . .	2-2
3-1.	MSS Server Home Page . . . . .	3-2
3-2.	Configuration and Console Page 1 . . . . .	3-3
3-3.	Diagnostic Menu . . . . .	3-3
3-4.	Configuration and Console Page 2 . . . . .	3-4
5-1.	OPCON in the Router Software Structure . . . . .	5-1
5-2.	OPCON Command Tree . . . . .	5-3
5-3.	Memory Utilization . . . . .	5-7
6-1.	CONFIG in the Router Software Structure . . . . .	6-2
9-1.	GWCON in the Router Software Structure . . . . .	9-1
10-1.	MONITR in the Router Software Structure . . . . .	10-1
11-1.	ELS in the Router Software Structure . . . . .	11-2
11-2.	Message Generated by an Event . . . . .	11-3
13-1.	FDDI Network Diagram . . . . .	13-3
18-1.	Physical and Logical Views of a Simple LAN Emulation Network . . . . .	18-2
18-2.	Default Connections Between LE Clients and the LES . . . . .	18-10
18-3.	Default Connection Between LE Clients (LECs) and BUS . . . . .	18-12
18-4.	LAN Emulation Redundancy . . . . .	18-16

---

## Tables

1-1.	Router Software Processes . . . . .	1-9
1-2.	Protocol Numbers and Names . . . . .	1-15
2-1.	File Transfer . . . . .	2-6
5-1.	OPCON Commands . . . . .	5-4
6-1.	Quick Config Capabilities . . . . .	6-3
6-2.	CONFIG Command Summary . . . . .	6-7
6-3.	Access Privileges . . . . .	6-9
6-4.	IBM 8210 Feature Numbers and Names . . . . .	6-16
6-5.	Additional Functions Provided by the Set Prompt Level Command . . . . .	6-24
7-1.	Change Management Configuration Commands . . . . .	7-3
9-1.	GWCON Command Summary . . . . .	9-2
11-1.	Logging Levels . . . . .	11-5
11-2.	Packet Completion Codes (Error Codes) . . . . .	11-6
11-3.	ELS Configuration Command Summary . . . . .	11-7
12-1.	ELS Console Command Summary . . . . .	12-6
13-1.	FDDI Configuration Command Summary . . . . .	13-4
14-1.	MAC Filtering Configuration Command Summary . . . . .	14-4
14-2.	Update Subcommands Summary . . . . .	14-9
15-1.	MAC Filtering Console Command Summary . . . . .	15-1
16-1.	Quality of Service (QoS) Configuration Command Summary . . . . .	16-7

16-2.	LE Client Quality of Service (QoS) Configuration Command Summary . . . . .	16-7
16-3.	LE Client Quality of Service (QoS) Configuration Command Summary . . . . .	16-12
17-1.	Quality of Service (QoS) Console Command Summary . . . . .	17-1
17-2.	LE Client QoS Console Command Summary . . . . .	17-2
19-1.	ATM Configuration Command Summary . . . . .	19-3
19-2.	ATM INTERFACE Configuration Command Summary . . . . .	19-4
19-3.	ATM Virtual Interface Configuration Command Summary . . . . .	19-11
20-1.	ATM Console Command Summary . . . . .	20-2
20-2.	ATM INTERFACE Configuration Command Summary . . . . .	20-3
21-1.	LAN EMULATION Client Configuration(?) Commands Summary . . . . .	21-2
21-2.	LAN Emulation Client Configuration Commands Summary . . . . .	21-5
21-3.	Ethernet IBM LAN Emulation Client Configuration Commands Summary . . . . .	21-15
22-1.	LE Config Console Command Summary . . . . .	22-2
23-1.	LAN EMULATION Services Configuration Commands Summary . . . . .	23-2
23-2.	LES-BUS Configuration Commands Summary . . . . .	23-4
23-3.	LECS Configuration Commands Summary . . . . .	23-15
23-4.	LECS ELANs Configuration Commands Summary . . . . .	23-20
23-5.	LECS ELANs Detailed Configuration Commands Summary . . . . .	23-23
23-6.	LECS Policies Configuration Commands Summary . . . . .	23-33
23-7.	LECS Interface Configuration Commands Summary . . . . .	23-36
24-1.	LAN EMULATION Services Monitoring Commands Summary . . . . .	24-3
24-2.	LES-BUS Monitoring Commands Summary . . . . .	24-6
24-3.	LECS Monitoring Commands Summary . . . . .	24-30
24-4.	LECS Policies Monitoring Commands Summary . . . . .	24-40
24-5.	ELAN Monitoring Commands Summary . . . . .	24-44
24-6.	ELAN Details Monitoring Commands Summary . . . . .	24-47
24-7.	Security for LE Services Monitoring Commands Summary . . . . .	24-54

---

## Notices

References in this publication to IBM products, programs, or services do not imply that IBM intends to make these available in all countries in which IBM operates. Any reference to an IBM product, program, or service is not intended to state or imply that only IBM's product, program, or service may be used. Any functionally equivalent product, program, or service that does not infringe any of IBM's intellectual property rights may be used instead of the IBM product, program, or service. Evaluation and verification of operation in conjunction with other products, except those expressly designated by IBM, are the user's responsibility.

IBM may have patents or pending patent applications covering subject matter in this document. The furnishing of this document does not give you any license to these patents. You can send license inquiries, in writing, to the IBM Director of Licensing, IBM Corporation, 500 Columbus Avenue, Thornwood, NY 10594 USA.

The licensed program described in this document and all licensed material available for it are provided by IBM under terms of the IBM Customer Agreement.

This document is not intended for production use and is furnished as is without any warranty of any kind, and all warranties are hereby disclaimed including the warranties of merchantability and fitness for a particular purpose.

---

## Trademarks

The following terms are trademarks of the IBM Corporation in the United States or other countries or both:

Advanced Peer-to-Peer Networking	CUA	Operating System/2
AIX	IBM	RISC System/6000
AIXwindows	Micro Channel	System/370
APPN	NetView	VTAM
BookManager	Nways	Web Explorer
Common User Access	OS/2	PS/2

Other company, product, and service names, which may be denoted by a double asterisk (\*\*), may be trademarks or service marks of others.



---

# Preface

This manual contains the information you will need to use the command line interface for configuration and operation of the IBM 8210 Nways Multiprotocol Switched Services (MSS) Server or the IBM Nways Multiprotocol Switched Services (MSS) Server module, hereafter referred to as “the router,” installed on your IBM Multiprotocol Switched Services (MSS) Server. With the help of this manual, you should be able to perform the following processes and operations:

- Configure, monitor, and use the Multiprotocol Switched Services (MSS) Server base code on your IBM 8210 Nways Multiprotocol Switched Services (MSS) Server or your IBM Nways Multiprotocol Switched Services (MSS) Server module
- Configure, monitor, and use the interfaces and Link Layer software supported by your router.

**Who Should Read This Manual:** This manual is intended for persons who install and manage computer networks. Although experience with computer networking hardware and software is helpful, you do not need programming experience to use the protocol software.

---

## Conventions Used in This Manual

The following conventions are used in this manual to show command syntax and program responses:

1. The abbreviated form of a command is shown in the following example:

`restart`

In this example, you can enter either the whole command (restart) or its abbreviation (res).

2. Three periods following an option mean that you enter additional data (for example, a variable) after the option. For example:

`time host ...`

In this example, you enter the IP address of the host in place of the periods, as explained in the description of the command.

3. In information displayed in response to a command, defaults for an option are enclosed in brackets immediately following the option. For example:

`Media (UTP/STP) [UTP]`

In this example, the media defaults to UTP unless you specify STP.

4. Keyboard key combinations are indicated in text in the following ways:

**Ctrl-P**

**Ctrl P**

---

## MSS Server Library

The following hard copy publications are shipped with the product. The manuals in this list are also included in displayable softcopy form on the Multiprotocol Switched Services (MSS) Softcopy Library CD-ROM (SK2T-0378). This CD-ROM is shipped with initial orders for the MSS Server.

The reference cards, the International Program License Agreement, and the safety information booklet are shipped in hard copy only and are not included on the CD-ROM.

- *IBM 8210 Nways Multiprotocol Switched Services (MSS) Server Setup and Problem Determination Guide*, GA27-4140
- *IBM 8210 Nways Multiprotocol Switched Services (MSS) Server Operations Reference Card*, GX27-4017
- *IBM Multiprotocol Switched Services (MSS) Server Configuration and Operations Guide*, SC30-3821
- *CAUTION: Safety Information - Read This First*, SD21-0030
- *International Program License Agreement*
- *IBM Nways Multiprotocol Switched Services (MSS) Server Module Reference Card*, GX27-4018
- *IBM Nways Multiprotocol Switched Services (MSS) Server Module Setup and Problem Determination Guide*, GA27-4141

The following publications are not shipped in hard copy, but are offered in soft copy form on the Multiprotocol Switched Services (MSS) Softcopy Library CD-ROM (SK2T-0378). All of these manuals can be separately ordered in hard copy form through your IBM marketing representative.

- *IBM Multiprotocol Switched Services (MSS) Server Introduction and Planning Guide*, GC30-3820
- *IBM Multiprotocol Switched Services (MSS) Server Command Line Interface Volume 1: User's Guide and Protocol Reference*, SC30-3818
- *IBM Multiprotocol Switched Services (MSS) Server Command Line Interface Volume 2: User's Guide and Protocol Reference*, SC30-3819
- *Event Logging System Messages Guide*, SC30-3682
- *IBM 8210 Nways Multiprotocol Switched Services (MSS) Server Service Manual*, GY27-0354

---

## Summary of Changes For Version 1 Release 1.1

The following are the hardware enhancements for the IBM 8210 in this release:

- FDDI adapter
- V33.6 V/D/F Modem
- ATM adapter upgraded to enhance performance

The following are the software enhancements for the IBM 8210 in this release:

- Support for the FDDI adapter and the V33.6 modem
- Improvements to ELAN and LEC to support ATM UNI 3.0 and 3.1 signalling
- IBM LEC support
- Super ELAN support
- Support for bridging as described in RFC 1483
- Quality of Service (QoS) feature
- Next Hop Resolution Protocol (NHRP)
- Improved BUS frame throughput
- Support for virtual ATM interfaces
- AppleTalk 2 support
- Redundant IP gateway support
- ARP Server Redundancy support
- Helps for the World Wide Web interface
- Command History for the Command Line Interface

The technical changes and additions are indicated by a vertical line (|) to the left of the change.





---

## Part 1. User's Guide

<b>Chapter 1. Getting Started (Introduction to the User Interface)</b> . . . . .	1-1
Before You Begin . . . . .	1-1
Using Local and Remote Router Consoles . . . . .	1-2
Discussing the User Interface System . . . . .	1-7
Accessing Protocol Configuration and Console Processes . . . . .	1-11
Accessing Feature Configuration and Console Processes . . . . .	1-15
Accessing Network Interface Configuration and Console Processes . . . . .	1-16
Command History for GWCON and CONFIG Command Line . . . . .	1-20
System Security . . . . .	1-23
<b>Chapter 2. Getting Started with the Configuration of the MSS Server</b> . . . . .	2-1
Physical Access Methods . . . . .	2-1
Configuration and Monitoring Tools . . . . .	2-3
File Transfer . . . . .	2-5
Initial Configuration . . . . .	2-6
Tips for Managing Configuration Problems . . . . .	2-7
Quick Configuration . . . . .	2-7
How Software Files Are Managed . . . . .	2-8
Brief Overview of the Functions of the MSS Server . . . . .	2-12
<b>Chapter 3. Using the World Wide Web Interface</b> . . . . .	3-1
Connecting to the World Wide Web Interface . . . . .	3-1
Home Page Structure . . . . .	3-2
Event Logging System . . . . .	3-4
Operator Console . . . . .	3-4
Router Configuration . . . . .	3-4
History Function . . . . .	3-5
Help System for the Web Browser Interface . . . . .	3-5
Quick Configuration Using the Web Browser Interface . . . . .	3-5
An Example of Quick Configuration Using the Web Browser Interface . . . . .	3-8
<b>Chapter 4. MSS Server Voice/Data/Fax Modem Support</b> . . . . .	4-1
Installation of the Voice/Data/Fax Modem . . . . .	4-1
Data/Fax Modem . . . . .	4-1
MSS Server Voice Access Using the Voice/Data/Fax Modem . . . . .	4-1
MSS Server Voice Pager Support . . . . .	4-2
Voice/Data/Fax Modem Menu Items . . . . .	4-4
<b>Chapter 5. The OPCON Process and Commands</b> . . . . .	5-1
What is OPCON? . . . . .	5-1
Accessing the OPCON Process . . . . .	5-2
OPCON Commands . . . . .	5-3
<b>Chapter 6. The CONFIG Process and Commands</b> . . . . .	6-1
What is CONFIG? . . . . .	6-1
CONFIG-Only Mode . . . . .	6-2
Quick Configuration . . . . .	6-3
Configuring User Access . . . . .	6-5
Entering and Exiting CONFIG . . . . .	6-6
CONFIG Commands . . . . .	6-7

<b>Chapter 7. The Boot/Dump Configuration Process and Commands</b>	7-1
Understanding Change Management	7-1
Using the Trivial File Transfer Protocol (TFTP)	7-1
Entering and Exiting Change Management Configuration Environment	7-2
Change Management Configuration Commands	7-2
<b>Chapter 8. Accessing the Firmware from the Command Line Interface</b>	8-1
Accessing the Firmware Prompt	8-1
Boot Options Available for the 8210	8-1
<b>Chapter 9. The GWCON (Monitoring) Process and Commands</b>	9-1
What is GWCON?	9-1
Entering and Exiting GWCON	9-2
GWCON Commands	9-2
<b>Chapter 10. The MONITR Process</b>	10-1
What is MONITR?	10-1
Commands Affecting MONITR	10-2
Entering and Exiting MONITR	10-2
Receiving MONITR Messages	10-2
<b>Chapter 11. Using and Configuring the Event Logging System (ELS)</b>	11-1
What is ELS?	11-1
Entering and Exiting the ELS Configuration Environment	11-2
Event Logging Concepts	11-3
ELS Configuration Commands	11-7
<b>Chapter 12. Monitoring the Event Logging System (ELS)</b>	12-1
Using ELS	12-1
Using ELS to Troubleshoot a Problem	12-3
Entering and Exiting the ELS Console Environment	12-5
ELS Console Commands	12-6
<b>Chapter 13. Using, Configuring and Monitoring FDDI</b>	13-1
Fiber Distributed Data Interface (FDDI) Overview	13-1
Accessing the FDDI Configuration Process	13-4
FDDI Configuration Commands	13-4
Accessing the FDDI Console Process	13-7
FDDI Console Commands	13-7
<b>Chapter 14. Using and Configuring MAC Filtering</b>	14-1
MAC Filtering Parameters	14-1
Accessing the MAC Filtering Configuration Prompt	14-3
MAC Filtering Configuration Commands	14-4
Update Subcommands	14-9
<b>Chapter 15. Monitoring MAC Filtering</b>	15-1
Accessing the MAC Filtering Console Prompt	15-1
MAC Filtering Console Commands	15-1
<b>Chapter 16. Using and Configuring Quality of Service (QoS)</b>	16-1
Quality of Service (QoS) Overview	16-1
Accessing the QoS Configuration Prompt	16-6
Quality of Service (QoS) Commands	16-7

	LE Client QoS Configuration Commands . . . . .	16-7
	ATM Interface QoS Configuration Commands . . . . .	16-12
	<b>Chapter 17. Monitoring Quality of Service (QoS)</b> . . . . .	17-1
	Accessing the QoS Console Commands . . . . .	17-1
	Quality of Service (QoS) Console Commands . . . . .	17-1
	LE Client QoS Console Commands . . . . .	17-2



---

## Chapter 1. Getting Started (Introduction to the User Interface)

This chapter shows you how to get started with using the following components related to the IBM Nways Multiprotocol Switched Services (MSS) Server Module (IBM 8210) and the IBM 8210 Multiprotocol Switched Services Server:

- Router console terminals
- Router software (IBM 8210 Multiprotocol Switched Services Server)
- Router software user interface
- Protocol software - configuring and monitoring
- Network interfaces - configuring and monitoring

The information in this chapter is divided into the following sections:

- “Before You Begin”
- “Using Local and Remote Router Consoles” on page 1-2
- “Discussing the User Interface System” on page 1-7
- “Accessing Protocol Configuration and Console Processes” on page 1-11
- “Accessing Feature Configuration and Console Processes” on page 1-15
- “Accessing Network Interface Configuration and Console Processes” on page 1-16
- “Command History for GWCON and CONFIG Command Line” on page 1-20
- “System Security” on page 1-23

---

### Before You Begin

Before you start, refer to the following checklist to verify that your router is installed correctly.

HAVE YOU...

- Installed all necessary hardware?
- Connected the console terminal (video terminal) to the router?

**Attention:** If you are using a service port-attached terminal to configure or monitor your IBM 8210 and your service terminal is unreadable, you need to change some parameters in your configuration. (See “Service Terminal Display Unreadable” in IBM Nways Multiprotocol Switched Services (MSS) Server Module Maintenance Information.)

- Connected your router to the network using the proper network interfaces and cables?
- Run all necessary hardware diagnostics?

For more information on any of these procedures, refer to the *IBM Nways Multiprotocol Switched Services (MSS) Server Module Planning and Setup Guide*.

---

# Using Local and Remote Router Consoles

The router console lets you use the router user interface to monitor and change the function of the router's networking software (IBM 8210 Multiprotocol Switched Services Server). The router supports local and remote consoles.

## Local Consoles

Local consoles are either directly connected by an RS-232 cable, or connected via modems to the router. You may need to use a local console during the initial software installation. After the initial setup connection, you can connect via Telnet, as long as IP forwarding has been enabled. (Refer to *Multiprotocol Switched Services (MSS) Server Command Line Interface Volume 2* for more information on enabling IP forwarding. )

When the configured router is started for the first time, a boot message appears on the screen, followed by the OPERator's CONsole or OPCON prompt (\*). The \* prompt indicates that the router is ready to accept OPCON commands.

Your IBM 8210 Multiprotocol Switched Services Server software may have been pre-configured at the factory. If it was, you do not need to use a local console to perform initial configuration. If, however, your IBM 8210 Multiprotocol Switched Services Server was not pre-configured at the factory, you will need to use an ASCII terminal attached to the IBM 8210 service port to initially configure it.

**Attention:** Garbage, random characters, reverse question marks, or the inability to connect your terminal to the IBM 8210 service port can have many causes. The following list contains some of those causes:

- The most common cause of garbage or random characters on the service console is that the baud rate is not synchronized with the IBM 8210.

If the IBM 8210 is set to a specific baud rate, the terminal or terminal emulator must be set to the same baud rate.

If the IBM 8210 is set to autobaud (this is the default), press the terminal break key sequence and press **Enter**.

A typical break key sequence for PC terminal emulators is Alt-b (refer to the terminal emulator documentation). Most ASCII terminals have a Break key (often used in conjunction with the Ctrl key).

- Defective terminal or device (A/C) grounds.
- Defective, incorrectly shielded, or incorrectly grounded RS-232 cable between the terminal and the IBM 8210.
- Defective terminal or terminal emulator.
- Defective IBM 8210 system board.
- High ambient electromagnetic interference (EMI) levels.
- Power line disturbances.

(See "Service Terminal Display Unreadable" in the *IBM Nways Multiprotocol Switched Services (MSS) Server Module Maintenance Information*.)

Once the IBM 8210 is initially configured, you will not need a local console for router operation, as long as IP forwarding is enabled.

The router software automatically handles console activity. When upgrading the software, you might have to use the local console. For information on attaching and configuring local consoles, refer to the *IBM Nways Multiprotocol Switched Services (MSS) Server Module Planning and Setup Guide*.

## Remote Consoles

Remote consoles attach to the router using a standard remote terminal protocol. Remote consoles provide the same function as local consoles, except that a local console must be used for initial configuration if your IBM 8210 was not pre-configured at the factory. You can use no more than two remote consoles at the same time on a router. You can connect remote consoles to the router via a Telnet connection (see “Telnet Connections”). You have the option to disable this feature.

### Telnet Connections

The router supports both Telnet Client and Server. The remote console on the router acts as a Telnet server. The router acts as a Telnet client when connecting from the router to either another router or a host using the **telnet** command in the OPCON (\*) process.

### Remote Login Names and Passwords

During a remote login, the router prompts you for a login name and password. You can display the login name when logged in to the router from a remote console by using a router **status** command.

Use the **set password** command to supply a password for the router. The password, user-configurable for each router, controls access to the router. You may also configure a password for users of a local console.

**Note:** If you do not enter a login name and valid password within one minute of the initial prompt, or if you enter an incorrect password three times in succession, the router drops the Telnet connection.

Multiple users with login permissions may also be added using the **add user** command. See Chapter 6, “The CONFIG Process and Commands” for more details on the **set password** and **add user** commands.

## Logging In Remotely or Locally

Logging in to a local console is the same as logging in to a remote console except that you must connect to the router by starting Telnet on your host system. To log in remotely, begin at step 1. To log in locally, begin at step 3 on page 1-4.

To log in from a remote console:

1. Connect to the router by starting Telnet on your host system.

Your host system is the system to which remote terminals are connected.

2. Supply the router's name or Internet Protocol (IP) address.

To use router names, your network must have a name server. Issue either the router name or the IP address as shown in the following example:

```
% telnet brandenburg
```

*or*

```
% telnet 128.185.132.43
```

The router supports both Telnet Client and Server. The remote console on the router acts as a Telnet server. The router acts as a Telnet client when connecting from the router to either another router or a host using the **telnet** command.

At this point, there is no difference whether you have logged in remotely or locally.

3. If you are prompted, enter your login name and password.

```
Login:  
Password:
```

It is possible that there is a login and no password. The password controls access to the router. If a password has not been set, press the **Enter** key at the Password: prompt. Logins are not set automatically. For security, you can set up user names and passwords using the **add user** command in the CONFIG process. For additional information, see the **add user** configuration command on page 6-8. Remember to reload or restart to activate their use.

**Note:** If you do not enter a login name and valid password within one minute of the initial prompt, or if you enter an incorrect password three times in succession, the router drops the Telnet connection.

4. Press the **Enter** key to display the main prompt asterisk (\*).

You may have to press the **Enter** key more than once or press **Ctrl P** to obtain the \* prompt.

Once at this level, you can begin to enter commands from the keyboard. Press the **backspace** key to delete the last character typed in on the command line. Press the **Delete** key or **Ctrl U** to delete the whole command line entry so that you can re-enter a command. See “Command History for GWCON and CONFIG Command Line” on page 1-20 for information on how to access previously entered commands.

Once at the main router prompt, you can begin entering commands from the keyboard. (See “Discussing the User Interface System” on page 1-7 for more information on using the router user interface.) To exit the router, return to the main router prompt (\*) and close the Telnet connection by typing **logout**. For example:

```
IP Config> exit  
Config> Ctrl P  
* logout  
  
%
```

You can also use local Telnet commands on your Telnet client to close the Telnet connection.

## Executing a Command

When typing a command, remember the following:

- Type only enough sequential letters of the command to make it unique among available commands. For example, to execute the **reload** command you must enter **rel** as a minimum.
- Commands are not case-sensitive.
- Sometimes, only the first letter of the command (and subsequent options) is required to execute the command. For example, typing **s** at the \* prompt followed by pressing the **Enter** key causes the **status** command be executed.



**Note:** If you use a VT100 terminal, do not press the **Backspace** key, because it inserts invisible characters. Use the **Delete** key.

## Connecting to a Process

When you start the router, the console displays a boot message. The OPCODE prompt (\*) then appears on the screen indicating that you are in the OPCODE process and you can begin entering OPCODE commands. This is the command prompt from which you communicate with different processes.

To connect your console to a process:

1. Find out the process ID (PID) number of a process by entering the **status** command at the \* prompt.

The **status** command displays information about the router processes, such as the process IDs (PIDs), process names and status of the process. Issuing the **status** command is shown in the following example:

```
* status

Pid Name      Status TTY Comments
  1 COpCon    RDY   TTY0
  2 Monitr    DET   --
  3 Tasker    RDY   --
  4 MOSDDT    DET   --
  5 CGWCon    DET   --
  6 Config    DET   --
  7 ROpCon    IDL   TTY1 128.185.210.125
  8 ROpCon    IDL   TTY2
  9 WEBCon    IDL   --
```

2. Use the **talk pid** command, where *pid* is the number of the process to which you want to connect. (For more information about these and other OPCODE commands, refer to Chapter 5, “The OPCODE Process and Commands.”)

**Note:** All the processes listed do not have a user interface (for example, the **talk 3** process). The **talk 4** command is for use by the software specialist.

## Identifying Prompts

Each process uses a different prompt. You can tell which process your console is connected to by looking at the prompt. (If the prompt does not appear when you enter the **talk pid** command, press the **Return** key a few times.)

The following list shows the prompts for the three main processes:

<u>Process</u>	<u>Prompt</u>
OPCON	*
GWCON	+
CONFIG	Config>

At the prompt level, you can begin to enter commands from the keyboard. Use the **Backspace** key to delete the last character typed in on the command line. Use **Ctrl U** to delete the whole command line entry so that you can re-enter a command. See “Command History for GWCON and CONFIG Command Line” on page 1-20 for information on how to access previously entered commands.

## Getting Help

At any of the prompts just described, you can obtain help in the form of a listing of the commands available at that prompt level. This is done by typing **?** (the **help** command), and then pressing the **Return** key. Use **?** to list the commands that are available from the current prompt level. You can usually enter a **?** after a specific command name to list its options. For example, the following appears if you enter **?** at the **\*** prompt:

```
*?
DIAGS hardware diagnostics
DIVERT output from process
FLUSH output from process
HALT output from process
INTERCEPT character is
LOGOUT
MEMORY statistics
RELOAD
STATUS of process(es)
TALK to process
TELNET to IP-Address
```

## Getting Back to OPCON

To get back to the OPCON prompt (**\***), press **Ctrl P**. You must always return to OPCON before you can communicate with another process. For example, if you are connected to the GWCON process and you want to connect to the CONFIG process, you must press **Ctrl P** to return to OPCON first. The **Ctrl P** key combination is called the *intercept character*.

When using third-level processes, such as IP Config or IP shown in Figure 1-1, use the **exit** command to return to the second level.

Use the intercept character (the default intercept character is **Ctrl P**) from a third-level process to return to the **\*** prompt. The next time you use the **talk** command, you will re-enter the third level process. This link goes away when the router is reinitialized.

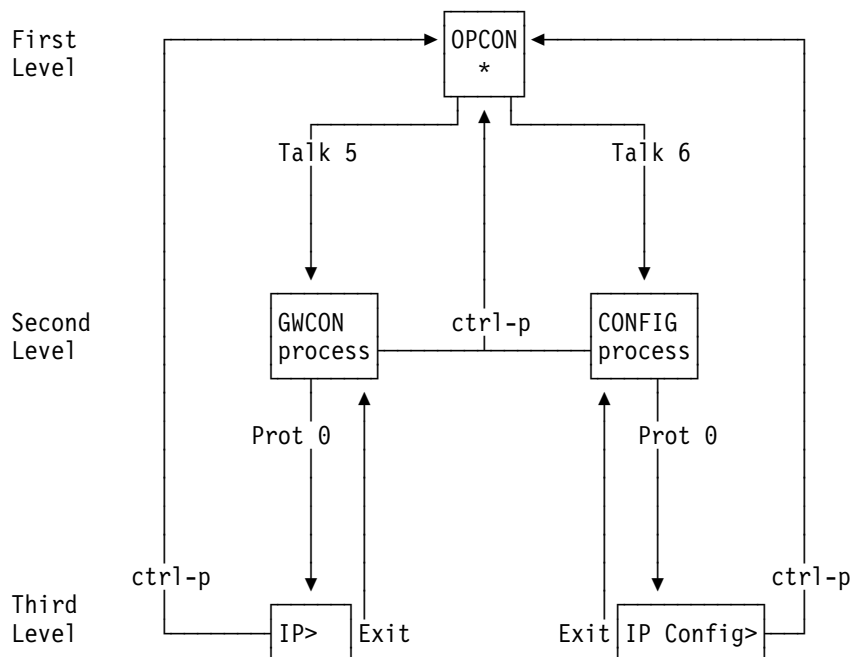

Figure 1-1. Talk and the Intercept Commands

Figure 5-2 on page 5-3 shows the commands in the OPCON structure.

## Exiting the Router

Return to the \* prompt and close the Telnet connection. For example:

```
IP Config> exit
Config> Ctrl P
* Logout

%
```

You can also use local Telnet commands on your Telnet client to close the Telnet connection.

---

## Discussing the User Interface System

The user interface to the router software consists of the main menu (process) and several subsidiary menus (processes). The processes you use most often are OPCON, GWCON, CONFIG, and CONFIG-ONLY. These processes allow you to control and monitor the operations of the router.

There are three levels of processes: first, second, and third as you move down the software tree.

Figure 1-2 shows the processes and how they fit within the structure of the router software.

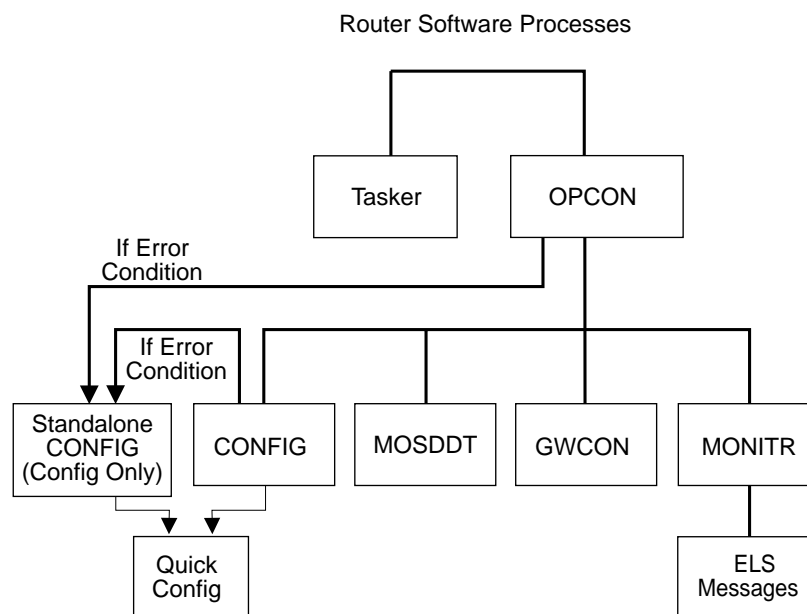

Figure 1-2. IBM 8210 Multiprotocol Switched Services Server

The router software (IBM 8210 Multiprotocol Switched Services Server) is a multi-tasking system that schedules use of the CPU among various processes and hardware devices. The router software:

## Getting Started

- Provides timing and memory management, and supports both local and remote operator consoles from which you can view and modify the router's operational parameters.
- Consists of functional modules that include various user interface processes, all network interface drivers, and all protocol forwarders purchased with the router.

| Table 1-1 on page 1-9 summarizes the IBM 8210 Multiprotocol Switched Services Server processes and functions on the IBM 8210.

Table 1-1. Router Software Processes

Process	Definition	Prompt
OPCON	Operates as the main operator control program. It provides service for one directly connected console terminal.	Asterisk (*)
ROPCON	Provides OPCON service for two remotely connected console terminals (not shown). Functionally, OPCON and ROPCON are the same.	Asterisk (*)
GWCON (or CGWCON) (Second Level)	Displays the status and statistics of the router's hardware and software, such as protocols, network interfaces, and event logging.  It is on the second level of the router user interface. It provides access to the third-level process, which allow you to monitor configured protocols and features.	Plus sign (+)
CONFIG (Second Level)	Provides online control of various configuration parameters, such as network addresses and event logging.  It is on the second level of the router user interface. It provides access to third-level processes, which allow you to configure various protocols and features.  Quick Config menus are also available under this process.	Config>
MONITR	Receives Event Logging System (ELS) messages and messages from the operating system, and displays them on the monitor, according to user-selected filtering criteria. It is on the second level of the router user interface.	None
TASKER	Runs the router's main networking software and performs the router's internetwork data transfer operations.  This process is part of the operating system and has no user interface.	None
MOSDDT	Serves as the Micro Operating System (MOS) runtime debugging tool (Dynamic Debugging Tool).	Dollar sign (\$)
QUICK CONFIG	Provides a simple, less-detailed way of configuring devices, bridging and routing protocols, and booting records.	None
CONFIG-ONLY (Standalone Config)	Provides the same function as the CONFIG process with the addition of the <b>reload</b> command.	Config (only)>
WEBCon	Runs the router's World Wide Web (WWW) interface. This process is part of the operating system and has no user interface.	

### Definition of the First-Level User Interface

The first level of the user interface includes CONFIG-ONLY and OPCON. The CONFIG-ONLY process (which includes Quick Configuration) allows you to configure the router. The OPCON process allows you to set up communication between users and the other router processes. If you are using a remote console, the name of the process handling your console is ROPCON instead of OPCON, but the operation is identical.

#### CONFIG-ONLY Process

Configuration Only, or CONFIG-ONLY, allows you to take the router off line and reconfigure its operating parameters.

The commands available are the same as CONFIG at the `Config>` prompt; however, no other processes are running while the router is in CONFIG-ONLY mode.

The CONFIG-ONLY mode uses commands identical to the CONFIG process, with the addition of the **reload** command.

CONFIG-ONLY mode is provided only for getting a subset of configuration commands when a configuration problem causes the router to crash with a *panic*, *check*, *fatal*, or *bughlt*, particularly those relating to failures of memory allocations. CONFIG-ONLY mode should be used only to adjust parameters affecting memory allocations such as routing table sizes, packet sizes, and receive buffer allocations. It should not be used for general router configuration. In CONFIG-ONLY mode, many of the device-related commands are disabled and some may cause a crash.

There are two ways to enter CONFIG-ONLY mode:

**Operational Failure:** The router encounters a problem during initialization and automatically comes up in CONFIG-ONLY mode. Any of the following situations will cause the router to enter into CONFIG-ONLY mode:

- An unsupported device is in the software load
- One or more of the following configuration errors have occurred during startup:
  - Static RAM is corrupted
  - All router interface information has been deleted.
  - Incorrect interface configuration information has been entered.

**Deliberate entry into CONFIG-ONLY mode:** To access CONFIG-ONLY mode deliberately, use the **PROM>bc** command when configuring boot options. See Chapter 8, “Accessing the Firmware from the Command Line Interface” for more detail.

#### Quick Configuration Process

Quick Configuration, or Quick Config, allows you to quickly configure portions of the router without dealing with the specific operating system commands. When you initially load, start, or restart the router with no configuration, you enter Config-Only and you can access Quick Config menus from that process. If the router has devices configured and the devices do not have any protocols configured, the router automatically starts Config-Only and then enters Quick Config.

You can also enter Quick Config from the CONFIG process using the **qconfig** command.

## OPCON

The OPCON process handles the communication between users and the other router processes. If you are using a remote console, the name of the process handling your console is ROPCON instead of OPCON, but the operation is identical.

Refer to Chapter 5, “The OPCON Process and Commands” for complete details.

---

## Accessing Protocol Configuration and Console Processes

To help you access the configuration and console processes, this section outlines both of these procedures.

All protocols described in the *Multiprotocol Switched Services (MSS) Server Command Line Interface Volume 2* have commands that are executed in one of the following ways:

- Accessing the protocol *configuration* process to initially configure and enable the protocol, as well as perform later configuration changes.
- Accessing the protocol *console* process to monitor information about each protocol or make temporary configuration changes.

The procedure for accessing these processes is basically the same for all protocols. The next sections describe these procedures.

## Accessing the Protocol Configuration Process (CONFIG)

Each protocol configuration process is accessed through the router’s CONFIG process. CONFIG is the second-level process of the router user interface that lets you communicate with third-level processes. Protocol processes are examples of third-level processes.

The CONFIG command interface is made up of levels that are called modes. Protocol configuration command interfaces are modes of the CONFIG interface. Each protocol configuration interface has its own prompt. For example, the prompt for the TCP/IP protocol command interface is `IP config>`.

To access the protocol configuration processes:

1. Enter the CONFIG command process from OPCON and obtain the CONFIG prompt (`Config>`)
2. Enter the desired protocol configuration process (with its own prompt) from the CONFIG prompt using the **protocol** command.

The next sections describe these procedures in more detail.

### Entering the CONFIG Process

To enter the CONFIG command process from OPCON and obtain the CONFIG prompt:

1. At the OPCON prompt, enter the **status** command to find the PID for CONFIG. (See page 1-5 for sample output of the **status** command.)
2. Enter the OPCON **talk** command and the PID for CONFIG. The PID for CONFIG is 6.  

```
* talk 6
```

The console displays the CONFIG prompt (Config>). If the prompt does not appear, press the **Return** key again.

**Quick Configuration Process** Quick Configuration, or Quick Config, allows you to quickly configure portions of the router without dealing with the specific operating system commands. You enter the Quick Config menus from the CONFIG process using the **qconfig** command.

### Entering the Desired Protocol Configuration Process

To enter the desired protocol configuration process from the CONFIG prompt:

1. At the CONFIG prompt, enter the **list configuration** command to see the numbers and names of the protocols purchased in your copy of the software. See 6-17 for sample output of the **list configuration** command.
2. From the Config> prompt, enter the **protocol** command with the number or short name (for example, IP, IPX, and ARP) of the protocol you want to configure. The protocol number and short name is obtained from the **list configuration** command display. In the following example, the command has been entered for accessing the IP protocol configuration process:

```
Config> protocol IP
```

*or*

```
Config> protocol 0
```

The protocol configuration prompt then displays on the console. The following example shows the IP protocol configuration prompt:

```
IP config>
```

You can now begin entering the protocol's configuration commands. See the corresponding protocol section of the *Multiprotocol Switched Services (MSS) Server Command Line Interface Volume 2* for more information on specific protocol configuration commands.

In summary, the **protocol** command lets you enter the configuration process for the protocol software installed in your router. The **protocol** command enters a protocol's command process. After entering the protocol command, the prompt of the specified protocol appears. From the prompt, you can enter commands specific to that protocol.



## Exiting the Protocol Configuration Process

To exit the protocol configuration process:

1. Return to the CONFIG process by entering the protocol **exit** command. For example:

```
IP config> exit
```

2. Return to the OPCODE process by entering the OPCODE intercept character (**Ctrl P**). For example:

```
Config> Ctrl P
```

## Reloading the Router

Changes that you make to the protocol parameters through CONFIG do not take effect until you reload the router software.

**Note:** The changes you make through CONFIG are retained in a configuration database in nonvolatile memory. They are retained during power downs and are recalled when you restart the router.

To reload the router, enter the OPCODE **reload** command. For example:

```
* reload
```

```
Are you sure you want to reload the gateway? (Yes or No): yes
```

## Accessing the Protocol Console (Monitoring) Process, GWCON

To view information about the protocols or to change parameters at the console, you must access and use the protocol console process. Protocol console command interfaces are modes of the GWCON interface. Within the GWCON mode, each protocol console interface has its own prompt. For example, the prompt for the TCP/IP protocol is IP>.

To access the protocol console processes:

1. Enter the GWCON command process from OPCODE and obtain the GWCON prompt.
2. Enter the desired protocol console process from the GWCON (+) prompt using the **protocol** command.

For more information on using the **protocol** command, see "Protocol" on page 9-12.

The next sections describe these procedures in more detail.

## Entering the GWCON Command Process

To enter the GWCON process from OPCODE and obtain the GWCON prompt:

1. At the OPCODE (\*) prompt, enter the **status** command to find the PID for GWCON. (See page 1-5 for sample output of the **status** command.)

2. At the OPCON prompt, enter the OPCON **talk** command and the PID for GWCON. For example:

```
* talk 5
```

The GWCON prompt (+) then displays on the console. If the prompt does not appear, press **Return** again.

### Entering a Protocol Console Process

To enter a protocol console process from the GWCON prompt:

1. At the GWCON prompt, enter the **configuration** command to see the protocols and networks configured for the router. For example:

```
+configuration
```

```
Nways 8210 Multiprotocol Switching Server
Host name: NCE #2
Version: 16.0[R1]
```

```
Num Name Protocol
0 IP DOD-IP
3 ARP Address Resolution
7 IPX Netware IPX
11 SNMP Simple Network Management Protocol
12 OSPF Open SPF-Based Routing Protocol
23 ASRT Adaptive Source Routing Transparent Enhanced Bridge
```

```
Num Name Feature
2 MCF MAC Filtering
6 QOS Quality of Service
```

```
6 Networks:
Net Interface MAC/Data-Link Hardware State
0 ATM/0 ATM CHARM ATM Up
1 ATM/1 ATM CHARM ATM Up
2 TKR/0 Token-Ring/802.5 CHARM ATM Up
3 Eth/0 Ethernet/IEEE 802.3 CHARM ATM Up
4 TKR/1 Token-Ring/802.5 CHARM ATM Up
5 Eth/1 Ethernet/IEEE 802.3 CHARM ATM Down
```

2. Enter the GWCON **protocol** command with the protocol number or short name of the desired protocol displayed in the configuration information.

In the following example, the command has been entered for accessing the IP protocol console process.

```
+ protocol 0
```

*or*

```
+ protocol IP
```

The protocol console prompt then displays on the console. This example shows the IP protocol console prompt:

```
IP>
```

You can now begin entering the protocol's commands. See the corresponding protocol section of the *Multiprotocol Switched Services (MSS) Server Command Line Interface Volume 2* for more information on specific protocol console commands.

## Exiting the Protocol Console Process

To exit the protocol console process and return to the OPCON process:

1. Return to the GWCON process by entering the protocol **exit** command. For example:

```
IP> exit
```

2. Return to the OPCON process by entering the OPCON intercept character (**Ctrl P**). For example:

```
+ Ctrl P
```

## Protocol Names and Numbers

Table 1-2 lists the numbers that you enter with the **protocol** command to access a specific protocol configuration or console process.

Protocol Number	Protocol Short Name	Accesses the following protocol process
0	IP	IP (Internet Protocol)
3	ARP	ARP (Address Resolution Protocol)
7	IPX	IPX (Novell NetWare Internetwork Packet Exchange)
10	BGP	BGP (Border Gateway Protocol)
11	SNMP	SNMP (Simple Network Management Protocol)
12	OSPF	OSPF (Open Shortest Path First)
23	ASRT	Adaptive Source Routing Transparent Bridge
24	HST	TCP/IP Host Services
29	NHRP	Next Hop Resolution Protocol

## Accessing Feature Configuration and Console Processes

To help you access the IBM 8210 Multiprotocol Switched Services Server feature configuration and console processes, this section outlines both of these procedures.

All IBM 8210 Multiprotocol Switched Services Server features described in this guide have commands that are executed in one of the following ways:

- Accessing the *configuration* process to initially configure and enable the feature as well as perform later configuration changes.
- Accessing the *console* process to monitor information about each feature or make temporary configuration changes.

The procedure for accessing these processes is basically the same for all features. The next sections describe these procedures.

### Accessing the Feature Processes

Use the **feature** command from the CONFIG process to access configuration commands for specific IBM 8210 Multiprotocol Switched Services Server features outside of the protocol and network interface configuration processes.

Use the **feature** command from the GWCON process to access console commands for specific features that are outside of the protocol and network interface console processes.

Enter a question mark after the **feature** command to display a listing of the features available for your software release. For example:

```
Config> feature ?
QOS
MCF

Feature name or number [2] ?
```

To access a particular feature's configuration or console prompt, enter the **feature** command at the Config> or + (GWCON) prompt, respectively, followed by the feature number or short name. For example:

```
Config> feature mcf

MAC filtering user configuration

Filter Config>
```

Table 6-4 on page 6-16 lists the available feature numbers and names.

Once you access the configuration or console prompt for a feature, you can begin entering specific commands for the feature. To return to the previous prompt level, enter the **exit** command at the feature's prompt.

---

### Accessing Network Interface Configuration and Console Processes

This section describes how to get started with accessing the network interface configuration and console processes. Accessing these processes lets you change and monitor software-configurable parameters for network interfaces used in your router.

Although this manual concerns itself primarily with configuration tasks, there might be some point during configuration when you want to display some interface statistics and information. To help you access both the configuration *and* console processes, this manual outlines both procedures. The information presented in the next sections includes:

- Accessing the Network Interface Configuration Process
- Accessing the Network Interface Console Process

### Accessing the Network Interface Configuration Process

Use the following procedure to access the router's configuration process. This process gives you access to a specific interface's *configuration* process.

1. At the OPCON prompt (\*), enter the **status** command to find the PID for CONFIG. (See page 1-5 for sample output of the **status** command.)

2. At the OPCON prompt, enter the OPCON **talk** command and the PID for CONFIG. (For more detail on this command, refer to Chapter 5, "The OPCON Process and Commands.") For example:

```
* talk 6
```

After you enter the talk 6 command, the CONFIG prompt (Config>) displays on the console. If the prompt does not appear when you first enter **CONFIG**, press **Return** again.

Use the **add device** command to create a network interface. The add device command automatically assigns the interface number and supports the following types of devices:

- a. Multi-port adapters

When you specify a multi-port adapter device name with the **add device** command, you are prompted for the adapter's slot number and the port number on the adapter that you want to use for the interface.

If you want to use multiple ports on an adapter, you must enter the add device command multiple times and specify a different port number each time.

For example, you would enter the following commands to create interfaces for ports 0 and 1 on the 8-port X.21 adapter in slot 7.

```
Config> add device x21
Device Slot #(1-8) [1]? 7
Device Port #(0-7) [0]? 0
Defaulting Data-link protocol to PPP
Adding 8 port X.21 PPP device in slot 7 port 1 as interface #6
Use "net 6" to configure 8 port X.21 PPP parameters
```

**Note:** The serial adapter port numbers are 0-based. The port numbers for all other multi-port adapters are 1-based.

- b. Single-port adapters

When you specify a single-port adapter device name with the **add device** command, you are prompted for the adapter's slot number.

The following example adds an interface for the 1-port ISDN-PRI T1/J1 adapter in slot 2.

```
Config> add device t1-isdn
Device Slot #(1-8) [1]? 2
Adding ISDN Primary T1/J1 device in slot 2 port 1 as interface #7
Use "net 7" to configure ISDN Primary T1/J1 parameters
```

- c. Dial circuits

The following example adds a dial circuit interface:

```
Config> add device dial-circuit
Adding device as interface 8
Defaulting Data-link protocol to PPP
Use "set data-link" command to change the data-link protocol
Use "net 8" command to configure circuit parameters
```

Enter **add device ?** to get a list of the supported device types.

### Note:

- When you create interfaces for serial adapters or dial circuits, the default data-link type is PPP. However, you can use the **set data-link** command to change the data-link type.

3. At the CONFIG prompt, enter the **list devices** command to display the network interface numbers for which the router is currently configured. For example:

```
Config> list devices
```

```
Ifc 0 CHARM ATM Adapter          Slot: 1 Port: 1
```

4. Record the interface numbers.

5. Enter the CONFIG **network** command and the number of the interface you want to configure. For example:

```
Config> network 1
```

The appropriate configuration prompt (such as ATM Config> for ATM), now displays on the console.

**Note:** Not all network interfaces are user-configurable. For interfaces that cannot be configured, you receive the message:

```
That network is not configurable
```

## Configuring the Network Interface

Refer to the specific chapters in this guide for complete information on configuring your IBM 8210's network interfaces.

The IBM 8210 supports 155 Mbps CHARM ATM interfaces.

## Exiting the Interface Configuration Process

After you have configured the interface information, exit the interface configuration process by using the following procedure:

1. Return to the CONFIG process by entering the **exit** command. For example:

```
ATM Config> exit
```

2. Return to the OPCON process by entering the OPCON intercept character.

The default intercept character is **Ctrl P**. (See "Intercept" on page 5-6 for more information.) For example:

```
Config> Ctrl P
```

## Reloading the Router

Whenever you change a user-configurable parameter, you must reload the router for the change to take effect. To do so, enter the OPCON **reload** command. For example:

```
* reload
```

```
Are you sure you want to reload the gateway? (Yes or No): yes
```

## Accessing the Network Interface Console Process

To monitor information related to a specific interface, access the interface console process by using the following procedure:

1. Enter the **status** command to find the PID for GWCON. (See page 1-5 for sample output of the **status** command.)

- At the OPCON prompt, enter the OPCON **talk** command and the PID for GWCON. For example:

```
* talk 5
```

- The GWCON prompt (+) is displayed on the console. If the prompt does not appear when you first enter GWCON, press **Return** again.
- At the GWCON prompt, enter the **configuration** command to see the protocols and networks for which the router is configured. For example:

```
+ configuration
```

```
Nways 8210 Multiprotocol Switching Server
Host name: [not configured]
Version: 1.0
```

```
Num Name Protocol
0 IP DOD-IP
3 ARP Address Resolution
11 SNMP Simple Network Management Protocol
12 OSPF Open SPF-Based Routing Protocol
23 ASRT Adaptive Source Routing Transparent Enhanced Bridge
```

```
Num Name Feature
2 MCF MAC Filtering
6 QOS Quality of Service
```

```
3 Networks:
Net Interface MAC/Data-Link Hardware State
0 ATM/0 ATM CHARM ATM Up
```

- Enter the GWCON **network** command and the number of the interface you want to monitor. For example:

```
+ network 0
```

In this example, the ATM console prompt is displayed on the console. You can then view information about the ATM interface by entering the ATM console commands.

```
ATM>
```

## Monitoring the Network Interface

Refer to the specific chapters in this manual for complete information on monitoring your IBM 8210's network interfaces.

## Exiting the Interface Console Process

To exit the interface console process and return to the OPCON process:

- Return to the GWCON process by entering the **exit** command. For example:

```
ATM> exit
```

2. Return to the OPCON process by entering the OPCON intercept character. (The default intercept character is **Ctrl P**.) For example:  
+ **Ctrl P**

---

### Command History for GWCON and CONFIG Command Line

The Command History contains up to the last 50 commands entered by the user in GWCON (Talk 5) or CONFIG (Talk 6) command line menus.

Backward and Forward retrieve keys can be used to recall previously entered commands. In addition, a facility is provided to enable the advanced user to repeat a particular series of commands.

### Repeating a Command in the Command History

By hitting **Ctrl B** (BACKWARD) or **Ctrl F** (FORWARD) at any command line prompt in a GWCON or CONFIG menu, the current command line is replaced by the previous or next command in the Command History. The Command History is common to both GWCON and CONFIG. That is, a command entered while in a GWCON menu can be retrieved from within CONFIG and a command entered while in a CONFIG menu can be retrieved from within GWCON.

The Command History contains the most recently entered commands, up to a maximum of the last 50 commands. If only three commands have been entered since a restart, hitting **Ctrl F** or **Ctrl B** circles through only those three commands. If no commands have been entered thus far, **Ctrl F** or **Ctrl B** results in a "bell", the same bell you see when trying to backspace beyond the beginning of a line of text.

**Note:** A command aborted by entering **Ctrl U** will not be entered into the Command History.

To enter two similar commands:

```
ELS>display sub les
```

```
ELS>display sub lec
```

Enter:

```
ELS>display sub les enter
```

```
ELS>Enter Ctrl B for BACKWARD, and the current line is  
replaced with-
```

```
ELS>display sub les
```

```
Enter backspace and replace "s" with "c" to get
```

```
ELS>display sub lec
```

```
then press enter
```



## Repeating a Series of Commands in the Command History

There is an additional feature for advanced users to facilitate repeating a particular series of GWCON or CONFIG commands. C1, C2,...,Cn in the Command History is referred to as a *repeat sequence*. This feature may be more convenient than simply using **Ctrl B** and **Ctrl F** when you must repeat a given task that requires multiple commands. Enter **Ctrl R** (REPEAT) to set the start of the *repeat sequence* at command C1. Enter **Ctrl N** (NEXT) successively to retrieve the next command(s) in the repeat sequence. Commands are not automatically entered, but are placed on the current command line allowing you to modify or enter the command.

To produce the desired behavior of a repeat sequence, the first command retrieved using the first **Ctrl N** (NEXT) depends on the manner in which the start of the repeat sequence was set using **Ctrl R** (REPEAT).

Setting the start of the repeat sequence with **Ctrl R** can be done in two ways:

1. When C1 is initially entered
2. When C1 is retrieved from the Command History with **Ctrl B** or **Ctrl F**.

### Starting a Repeat Sequence As Commands Are Entered

If you enter **Ctrl R** as command C1 is being keyed in, and then enter commands C2, C3... Cn. **Ctrl N** will successively bring commands C1, C2, ... Cn, C1, C2, ... Cn, C1, ... to the command line.

In Example 1, the start of the repeat sequence is set as the first command is keyed in. The user knows ahead of time that the same commands to be entered in GWCON need to be repeated in CONFIG.

#### Example 1

1. As the first command in the sequence is keyed in, use **Ctrl R** (REPEAT) to set the start of the repeat sequence.

```
*talk 5
+event-enter Ctrl R for REPEAT to set the start of the
repeat sequence-
+event enter
```

2. Continue typing the subsequent commands in the sequence:

```
Event Logging System user console
ELS>display sub les
ELS>display sub lec
ELS>exit
+
```

3. To enter these same commands in CONFIG, press **Ctrl P** (the default OPCON intercept character) and go to CONFIG.

```
+--press Ctrl P -
*talk 6
Config>-press Ctrl N for NEXT to retrieve the start of
      this sequence-
Config>event enter
Event Logging System user configuration
ELS config>-press Ctrl N for NEXT to retrieve the next
      command in sequence-
ELS config>display sub les enter
ELS config>-press Ctrl N for NEXT to retrieve the next
      command in sequence-
ELS config>display sub lec enter
ELS config>-press Ctrl N for NEXT to retrieve the next
      command in sequence-
ELS config>exit enter
Config>
```

### Starting a Repeat Sequence After All Commands Are Entered

On the other hand, if you first enter C1, C2, ... Cn, and retrieve C1 via **Ctrl B** or **Ctrl F**. Entering **Ctrl R**, entering **Ctrl N** successively brings commands C2,..., Cn, C1, C2,..., Cn, C1,...,Cn to the command line (see Example 2). The first occurrence of C1 is bypassed since C1 is already available on the command line at the time it was retrieved, and does not need to be recalled again by the first **Ctrl N**.

In Example 2, all the commands are entered and then the first command command in the sequence to be repeated is retrieved. A sequence of commands has been entered in GWCON, and the same sequence needs to be repeated in CONFIG.

#### Example 2

1. Enter the following commands in GWCON:

```
*talk 5
+event
Event Logging System user console
ELS>display sub les
ELS>display sub lec
ELS>exit
+
```

2. To enter these same commands in CONFIG, press **Ctrl P** (the default OPCON intercept character) and go to CONFIG.

```

+-press Ctrl P -
*talk 6
Config>-press Ctrl B four times to retrieve the start of
the four command sequence in this example-
Config>event
Config>event-press Ctrl R for REPEAT to set the start of
the repeat sequence-
Config>event enter
Event Logging System user configuration
ELS config>-press Ctrl N for NEXT to retrieve the next
command in sequence-
ELS config>display sub les enter
ELS config>-press Ctrl N for NEXT to retrieve the next
command in sequence-
ELS config>display sub lec enter
ELS config>-press Ctrl N for NEXT to retrieve the next
command in sequence-
ELS config>exit enter
Config>

```

If the OPCON **intercept** command described in Chapter 5, “The OPCON Process and Commands” on page 5-1 has been used to redefine the OPCON intercept character from the default character **Ctrl P** to one of the Command History control characters, **Ctrl B**, **Ctrl F**, **Ctrl R**, or **Ctrl N**, the OPCON intercept character will take priority. For example, if the intercept character has been changed to **Ctrl F**, then **Ctrl F** will not retrieve Forward in the Command History, but will instead place the user back at the OPCON prompt (\*).

---

## System Security

Multiple users with login permissions can also be added using the **add user** command. See “Configuring User Access” on page 6-5 for details on security issues and for information on the **set password** and **add user** commands.



---

## Chapter 2. Getting Started with the Configuration of the MSS Server

This chapter explains how to access the MSS Server using a workstation and how to manage operational software images and configuration files. It also provides a brief overview of the functions of the MSS Server.

---

### Physical Access Methods

Before the MSS Server has been configured, it cannot yet function in the ATM network. Therefore, you have to access it in one of the following ways:

- Through a null modem cable attached to the EIA 232 service port. This is known as local connection.
- Through one of the PCMCIA modems, or through a modem attached to the EIA 232 service port. The PCMCIA modems are the Voice/Data/Fax Modem and the Data/Fax Modem. These are the forms of remote connection, which rely on the telephone lines.

You can set up both a local and a remote connection to the MSS Server. However, only one port can be active at any given time. If a workstation is connected locally to the serial port and a call comes in over the Voice/Data/Fax Modem or the Data/Fax Modem, priority is given to the call. After the call, the workstation will have to log back into the MSS Server.

With local or remote connection, you can use a teletypewriter (TTY) connection. TTY requires communications software to enable file transfer.

Alternatively, you can use Serial Line Internet Protocol (SLIP) over the local or remote connection. If you use SLIP, you must have Transmission Control Protocol/Internet Protocol (TCP/IP) running on your workstation.

You can continue to use local or remote access to the MSS Server after it has been configured. However, after configuration, you can also use Internet Protocol (IP) or LAN emulation to access the MSS Server through the ATM network. For the IBM 8210 Nways Multiprotocol Switched Services (MSS) Server, the connection is made over optical fiber from one of the ATM connectors; for the IBM Nways Multiprotocol Switched Services (MSS) Server Module, the connection is made through the ATM switch in which the module is installed.

Figures 2-1, 2-2, and 2-3 show local connection, remote connection using the PCMCIA modem, and connection over the network.

## Getting Started with MSS Server Configuration

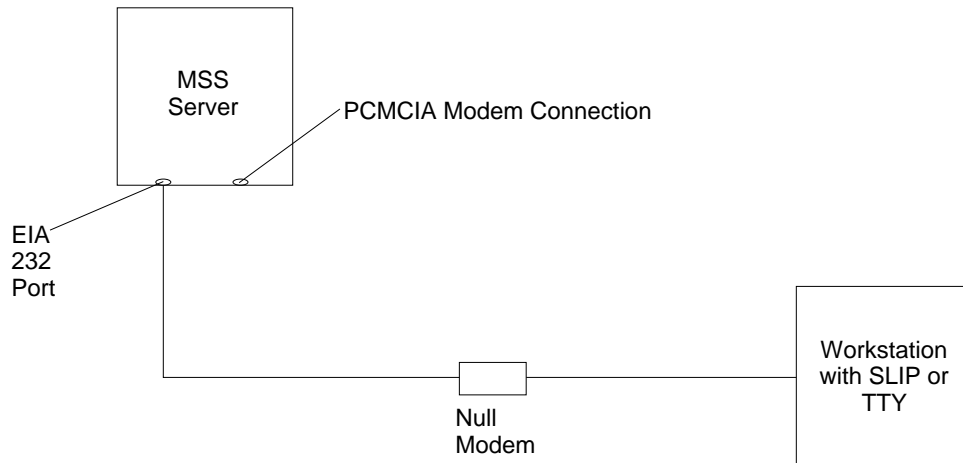

Figure 2-1. Local Serial Connection to the EIA 232 Port

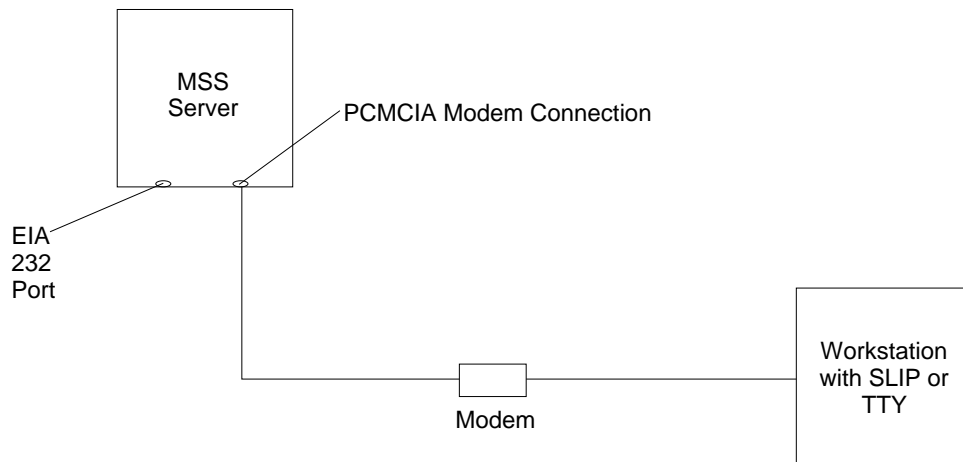

Figure 2-2. Remote Serial Connection to the PCMCIA Modem (Voice/Data/Fax Modem or Data/Fax Modem)

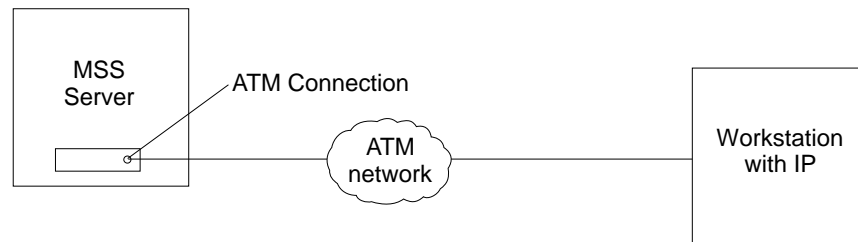

Figure 2-3. Connection Using IP Over the ATM Network. Shown with the server. The server or the module must be operational in the network to use this connection.

## SLIP Addresses

To configure SLIP, use these addresses:

**The IP address of the workstation**

10.1.1.3

**The IP address of the MSS Server**

10.1.1.2

For instructions about installing SLIP, refer to the documentation for your version of TCP/IP.

## Serial Port and Data/Fax Modem Default Settings

These are the default settings for the serial port:

**Speed** 19.2 Kbps

**Parity** None

**Data Bits** 8

**Stop Bits** 1

The Data/Fax Modem is a 28.8 bps V.32 bis modem. It is set up with a default speed of auto detect. The parity, data bits, and stop bits are the same as those of the serial port: None, 8, and 1.

Once the MSS Server operational code has loaded, the line speed for the serial port is automatically set to 9600 baud.

---

## Configuration and Monitoring Tools

These are the various configuration and monitoring tools that are supported by the physical connections:

### **Multiprotocol Switched Services Configuration Program**

This is a standalone program that is installed in a workstation that is connected to the MSS Server. The workstation must be running TCP/IP. You must use this program differently before and after the initial configuration of the MSS Server.

#### **Before configuration:**

Connection to the MSS Server must be through the modem or the service port, over a serial link. While the MSS Server is in this state, you cannot use the Communications options of the Configuration Program. You can create configuration files and download them to the MSS Server over the serial link using TFTP over SLIP. The workstation must be running TCP/IP. **After configuration**

The configuration file that you download over a serial link can provide an IP address and subnet mask to the MSS Server, or establish LAN emulation. After you have configured the MSS Server and made it operational in the ATM network, you can access it through the network.

When the MSS Server is in this state, you can use the Communications Send option of the Configuration Program to send configuration files from the workstation over the network to the MSS Server. If you are using the version of the Configuration Program that is supported by AIX, you can also use the Communications Retrieve option of the Configuration Program to retrieve configuration files from the MSS Server.

### Web browser Hypertext Markup Language (HTML) interface

The Web browser interface is a configurator that is a home page and is accessed by a Web browser from a workstation that is connected to the MSS Server. You need a Web browser that can display clickable images and tables. The Web browser interface can be accessed using SLIP or IP. You must use the serial line connection and SLIP before the MSS Server is operational in the network.

If you give the Web browser the SLIP address, one of the configured IP addresses of the MSS Server, or its name (if you use an IP name server), the Web browser interface will come up.

**Note:** The configured IP addresses of the MSS Server include the IP addresses of all the LAN emulation servers and Classical IP clients.

### Command line interface

The command line interface is a teletypewriter (TTY) text interface that requires you to enter commands to use it. The workstation that accesses it must be either an ASCII terminal or a personal computer (PC) or other intelligent programmable workstation emulating an ASCII terminal.

This interface must be reached over a serial link before the MSS Server is operational in the network; you can use TTY or SLIP to access it. If you use SLIP, you can Telnet into the MSS Server.

After the MSS Server is operational in the ATM network, you can Telnet into the MSS Server over IP to bring up this interface. If one connection to the MSS Server is a Telnet session, the MSS Server can support two connections at one time.

The command line interface is marked by an asterisk (\*) prompt. Refer to the *IBM Multiprotocol Switched Services (MSS) Server Command Line Interface Volume 1: User's Guide and Protocol Reference* for a full description of this interface.

**Important:** If you use a serial connection, (either local or remote), you **must press a key** to bring up the asterisk that is the prompt for the command line interface. When you make the connection, the message Please press a key to obtain console appears and reminds you to do this.

### Voice/Data/Fax Modem or Data/Fax Modem

The Voice/Data/Fax Modem is an integrated modem with both voice and fax capabilities that is shipped with the MSS Server in the U.S. and Canada. It provides access using touch tone telephone input with automated voice responses. In addition to faxing an alert after the MSS Server has had a failure and has restarted, it can fax other reports that monitor the MSS Server and it can change a few dynamic parameters that help to maintain the MSS Server in the network.

The Data/Fax Modem is an integrated PCMCIA modem that handles data and can fax an alert from the MSS Server. For example, it can fax an alert from the MSS Server if the MSS Server has had a failure and has then automatically restarted.

Both of these modems provide full text console access to the command line interface. They provide remote connection that supports either the TTY or SLIP access. The Voice/Data/Fax Modem provides access using the voice interface to several configuration parameters, including enabling or disabling thermal shutdown for the standalone server only.



### Fax Accumulation

If several undeliverable faxes are sent from the Voice/Data/Fax interface, they will not be deleted. They will accumulate as new faxes are added and sent when possible. The most common cause of fax delivery failure is a missing or incorrect fax telephone number.

### Local and Remote Console Access

When accessing the MSS Server locally on a null modem cable attached to the EIA service port or remotely through the PCMCIA modem, use VT100 terminal emulation. Because VT100 does not define function keys above F4, edit the keyboard mapping manually as follows: For F6, enter the mapping (ESC)OU. For F9, enter the mapping (ESC)(Left square bracket)009q.

**Note:** (ESC) represents the carat symbol followed by the left square bracket.

Also note that a PING done on the PCMCIA modem may take up to 2 minutes.

### Remote Voice Access

When dialing the number for voice access to the MSS Server, detection of the user is not automatic, as implied in "Voice/Data/Fax Modem Menu Items" on page 4-4. The user will be asked to press the # key. If the user fails to do this, the server assumes the caller is a modem and will subsequently send a carrier signal. If the # key is pressed, operation proceeds as given in "Voice/Data/Fax Modem Menu Items" on page 4-4.

---

### File Transfer

Table 2-1 on page 2-6 defines the ways in which configuration files and operational software files can be transferred to and from the MSS Server.

## Getting Started with MSS Server Configuration

Table 2-1. File Transfer

File Transfer Method	Type of Connection
<p>TFTP Get command from the MSS Server to the workstation that has the binary configuration file, to download operational software images and configuration files to the MSS Server. Files sent using TFTP must be binary, or the MSS Server cannot use them. You should use the Create command of the Configuration Program to save configuration files in binary format before downloading them to the MSS Server.</p> <p>After the MSS Server is operational in the network, you can use the TFTP Put command over IP to upload a file from the MSS Server to a workstation. The file will be uploaded in binary format. Both operational software and configuration files can be uploaded.</p> <p>You should use the Read router configuration option of the Configuration Program to make an uploaded configuration file usable by the Configuration Program so that you can change some parameter values in it.</p> <p><b>Note:</b> Using TFTP Put is a way to retrieve files from the MSS Server if the Retrieve option of the Configuration Program is not available.</p>	<ol style="list-style-type: none"><li>1. SLIP connection (using the TFTP Get command to download files to the MSS Server).</li><li>2. IP connection of operational MSS Server over functioning network (using the TFTP Get and Put commands to download and upload files).</li></ol>
<p>The Communications Option of the Configuration Program (actually, the protocol for this is SNMP). This method cannot be used until the MSS Server is operational in the network. The files are not binary, but are in a format that is internal to the Configuration Program. This function can send configuration files to the MSS Server and retrieve them from the server.</p>	<p>IP connection of operational MSS Server over functioning network.</p>

## Initial Configuration

After the MSS Server has passed its hardware diagnostics, it is in a ready state for configuration. These are two examples of ways to complete the first configuration:

### First Example

1. Use the Configuration Program to create a binary configuration file.
2. Download the file to the MSS Server using TFTP over SLIP.
3. Restart the MSS Server to make the configuration active. If your configuration file included all the necessary parameters, the MSS Server should now be completely operational in the network.

### Second Example

1. Use a SLIP or a TTY connection over a serial link to access the MSS Server.
2. Bring up the Web browser interface or the command line interface.
3. Use quick configuration to do a minimal configuration of the MSS Server, including IP address and SNMP. See "Quick Configuration" on page 2-7.
4. Restart the MSS Server to activate the quick configuration.

5. Next, make and save a configuration file using the Configuration Program. Use either the TFTP Get command over SLIP or IP or use the Communications Options Send command of the Configuration Program to download the configuration file.

If you use TFTP, you must use the Create option of the Configuration Program to create binary files and then TFTP them to the MSS Server.

6. Restart the MSS Server to make the configuration active. If your configuration file included all the necessary parameters, the MSS Server should now be completely operational in the network.

---

### Tips for Managing Configuration Problems

**Important:** After the MSS Server is configured and operational, *always* back up the active configuration file. Keeping this file enables you to re-establish the MSS Server on the network should the active configuration become corrupted.

You can back up the active configuration file by retrieving it and storing it in the workstation. See “File Transfer” on page 2-5 for more information.

### Reconfiguring

You can find it hard to detect problems caused by configuration errors. A configuration error can initially appear to be a hardware problem because the MSS Server will not start or data will not flow through a port. In addition, problems with configuration may not result in an error initially; an error may occur only when specific conditions are encountered or when heavy network traffic occurs.

If you cannot resolve a problem after making a few changes to your configuration or after restoring the active configuration file, it is recommended that you generate a new configuration. Too many changes to a configuration often compound the problem, whereas you can usually generate and test a new configuration within a few hours.

---

### Quick Configuration

Quick configuration is a process for initial configuration that is available either from the Web browser interface or from the command line interface. It produces a simple configuration that will enable the MSS Server to run in the network. The Web browser interface, which is the more usable of the two interfaces, is recommended. See “Quick Configuration Using the Web Browser Interface” on page 3-5 for a description of quick configuration using the Web interface.

### Completing the Configuration After Quick Configuration

After you have completed quick configuration, you must reload the MSS Server to activate the configuration. Then, you can access the MSS Server over the network, if you have configured an IP address for it.

The configuration provided by QCONFIG depends upon many default values for parameters, some of which may not be appropriate to your installation. You may need to modify the configuration that you have created using QCONFIG to

## Getting Started with MSS Server Configuration

customize the MSS Server to work on your network. You can do this using any of these methods:

- Configuration Program
- Web browser HTML interface
- Command line interface

However, the Configuration Program is the preferred configuration method for these reasons:

1. It can enable you to keep a number of copies of configuration files on a server for uploading to the appropriate MSS Servers.
2. It does not alter any configuration parameters dynamically. This feature helps you control changes to the MSS Server configurations.
3. It performs more input validation and cross-checking of the configuration parameters than the other methods.

The command line interface and the Web browser interface cause certain parameters to be altered dynamically. The binary files that they create are saved on the hard disk of the MSS Server, not in the workstation. These characteristics make them more difficult to use for managing the configuration of the MSS Server. However, they can be used to monitor the operations of the MSS Server, whereas the Configuration Program cannot. They are also useful when you want to change one of the parameters that can be dynamically altered.

---

## How Software Files Are Managed

To help you manage operational software upgrades and configurations, the MSS Server has a software change management feature. This utility enables you to determine which operational software file and which configuration file is active while the MSS Server is running. In addition to storing the active operational software and the active configuration file, the MSS Server stores two backup images of the operational software and up to 11 configuration files in memory.

## How to View the Files

To use the change management tool in the command line interface to view the operational software image and the configuration files, follow these steps:

1. From the prompt for OPCON, which is an asterisk (\*), type **talk 6**. The prompt `Config>` appears.
2. Enter **boot**. You will see the prompt `Boot config>`.
3. Enter **list** to display information about which load images and configuration files are available and active.

See "LIST" on page 7-9 for sample list output and a description of file statuses.

## How to Reset the MSS Server

**Note:** A reset interrupts the function of the MSS Server for up to 90 seconds. Be sure that the network is prepared for the interruption.

As previously stated, PENDING and LOCAL files are not loaded into active memory until you reset the MSS Server.

You can reset the MSS Server using any one of these methods:

- Press the hardware reset button.
- At the `Config only>` prompt, type **reload**.

**Note:** The `Config only>` prompt appears when config no file is active. Lack of an active config file indicates that an active configuration has become corrupted or that the MSS Server is not configured.

- At the `OPCON` prompt (\*), type **reload**.

### File Transfer Using TFTP

See “TFTP command” on page 7-12 for a sequence of commands to transfer a file from a workstation or server to the MSS Server using TFTP. You will need to substitute your own values for the IP address and path, which are given as examples.

### Storing Configuration Files Using the Command Line Interface or the Web Browser Interface

To store a configuration file that you have created using the command line interface, type **write** at the `Config>` prompt. If you are using the Web browser interface, select *Write*. The Write command creates a binary configuration file that contains the most current value of each of the configuration parameters.

This file is stored in the ACTIVE bank and is given PENDING status. If the status of the file is not changed by a Set command, it becomes the ACTIVE configuration when the MSS Server is reset.

### Changing the Statuses of Files

These are the ways to change the statuses of image and configuration files:

- You can cause the MSS Server to perform a reset by using the Send command from the Communications Option of the Configuration Program. When you do this, the file that you send can arrive as a PENDING file or as an AVAIL file. If it is a PENDING file, it becomes the ACTIVE configuration and the previously ACTIVE file becomes AVAIL when the MSS Server is reset.

If it is an AVAIL file, resetting the MSS Server does not change its status.

- You can use the Set config (set config) commands from the `Boot config>` prompt manually to change the status of any files except the ACTIVE files. If you set a file to PENDING, it becomes ACTIVE and the ACTIVE file becomes AVAIL when a reset is performed.
- When you use the Write command to store a configuration file that you have created using the command line interface or the Web browser interface, it is stored with a PENDING status.
- If you copy a file from one location to another, the file receives the status of the file that was there before it and that it overwrites. For example, if you copy a file with the status of AVAIL over a file that has the status of PENDING, the new file will keep the status of the original file, which is PENDING.

### Using the Configuration Program to Manage the Configuration Files

For optimal configuration management, it is recommended that you use the Configuration Program and its configuration data base to manage all your MSS Server configuration files.

The design of change management facilitates good control of the configuration files. Keeping the ACTIVE file and the file that is stored in the configuration data base the same assures that a copy of the ACTIVE file is always available.

When you use the Send option to send a new configuration to the MSS Server, the new configuration is written to the ACTIVE bank and overwrites the file located in the position just below the currently ACTIVE configuration. The new configuration is PENDING if a time is set for a reset. If the configuration file is sent without a specified time for the reset to occur, it gets AVAIL status.

For example, suppose that CONFIG 2 is ACTIVE. The new configuration file is written to CONFIG 3. It has a status of PENDING if a reset time is associated with it; if not, it has a status of AVAIL.

If the file has a status of PENDING, CONFIG 2 becomes AVAIL and CONFIG 3 becomes ACTIVE when a reset occurs. The next file that is sent from the Configuration Program will be placed in CONFIG 4. If a reset time is associated with the file, it will have the PENDING status and will become ACTIVE when the next reset occurs. If another file is then sent, it is placed in CONFIG 1 because the currently ACTIVE file is now in CONFIG 4. This arrangement results in a circular queue.

If the downloaded file has a status of AVAIL, a reset does not change its status. If another file is sent down, it overwrites that file because the ACTIVE file has not changed and the newly downloaded file always occupies the location just behind the ACTIVE file.

### Using the Set Commands

See "SET command" on page 7-11 for information about the **Set** command.

### Other Change Management Functions

These are the other change management commands:

- Describe load images
- Describe config images
- Disable dumping
- Enable dumping
- Erase files

#### **Describe**

See "DESCRIBE command" on page 7-6 for information about the **Describe** function.

### Disable Dumping

The MSS Server can be set up to dump the contents of memory to permanent storage in the unlikely event of a complete system failure. If dumping is enabled, using this selection will cause the MSS Server *NOT* to dump to disk.

To disable dumping, type **t 6** at the \*, press **Enter** and then type **disable dump** or **dis du** at the Config> prompt. You will see the message:

```
Config> Automatic memory dump disabled
```

### Enable Dumping

This command enables the dumping of memory without intervention from anyone in the event that the MSS Server has a catastrophic error. The MSS Server will dump memory onto the hard disk or flash memory. Once a successful dump has been taken, the MSS Server attempts to restart. Depending upon the failure of the MSS Server, it cannot always restart. In this case, you should restart it manually and call a service person, who will dial into the MSS Server to determine the nature and the causes of the failure.

To enable dumping, type **t 6** at the \*, press **Enter** and then type **enable dump** or **ena du** at the Config> prompt. You will see the message:

```
Config> Automatic memory dump enabled
```

The default state is to have dumping enabled.

### Erase Files

See “ERASE command” on page 7-7 for information about the **erase** command.

## Using the Copy Command

The Copy command allows you to move a file from one location in the storage area to another. This command allows you to change the status as well. The file that you move always receives the status of the storage area that it is moved to. For example, suppose that you have this scenario:

- The configuration file in BANK A CONFIG 1 is AVAIL. The configuration file in BANK B CONFIG 1 is PENDING.
- You copy the configuration in BANK A CONFIG 1 to BANK B CONFIG 1.

In this case, the original configuration file in BANK A CONFIG 1 remains unchanged and AVAIL. The configuration that was in BANK B CONFIG 1 is overwritten by a copy of the configuration file that is in BANK A CONFIG 1. This copy retains the status of the file that it overwrote, in this case, PENDING.

See “COPY” on page 7-5 for additional information about the **copy** command.

## Using the Lock Command

The **lock** command allows you to prevent the server from overwriting the selected configuration with any other configuration.

See “LOCK” on page 7-10 for additional information about the **lock** command.

### Using the Unlock Command

The **unlock** command removes the lock from a configuration allowing the configuration to be updated.

See “UNLOCK” on page 7-12 for additional information about the **unlock** command.

---

### Brief Overview of the Functions of the MSS Server

Release 1.0 of the MSS Server contains four basic functions:

1. LAN Emulation
2. Classical IP
3. Routing
4. Bridging



---

## Chapter 3. Using the World Wide Web Interface

The MSS Server provides a World Wide Web interface to monitor and configure the product. The Web browser interface performs all of the functionality of the command line interface, but in a graphical, more user-friendly manner.

---

### Connecting to the World Wide Web Interface

There are four mechanisms for accessing the Nways MSS Server using the Web interface:

- Locally, over the service port with a workstation that communicates using Serial Line IP (SLIP).
- Remotely, over an external modem connection to the service port. As with the local connection, the workstation must support SLIP.
- Remotely, using the integrated Voice/Data/Fax Modem or the Data/Fax Modem PCMCIA modem. This connection must also support and be running SLIP.
- Through a LAN emulation (LE) client or Classical IP interface running over the ATM adapter. This connection works over an MSS Server that has been configured and is operational in the network.

To use this connection, provide the browser with the IP address of one of the LAN emulation servers (LEs) on any subnet or with the IP address of one of the Classical IP clients.

You may use any web browser that supports HyperText Markup Language (HTML) tables and clickable images. Examples of browsers that support this feature are WebExplorer Version 1.03 or higher, Netscape Navigator Version 1.1N or higher, and Mosaic Version 2.1.1 or higher.

In order to access the Home Page of the MSS Server, point your browser to the Universal Resource Locator (URL) `http://<machine>/`, where `<machine>` is either the name or one of the configured IP addresses of the MSS Server.

You will be shown the Home Page that is described in the next section.

**Note:** Before you can use the Web browser, the MSS Server must have been configured with an IP address. This address can either be a network address or a SLIP address. The default SLIP address for the MSS Server is:

10.1.1.2

Use this source IP address to identify the workstation:

10.1.1.x

The letter *x* stands for any value.

### Rules for Using the Web Interface

When you perform configuration using the Web browser interface, you should observe the following guidelines:

- Many configuration options require you to enter data on two or more Web pages (or forms). If you fill in and submit the first form in a series, be sure to

complete the remaining forms. If you do not fill in and submit all the forms, the configuration parameter could be left in an unknown state.

- Two people should not perform configuration at the same time. They can interfere with one another. For example, one person could delete an interface while the other person is in the middle of configuring a protocol on that interface.
- You should disable the caching feature of the browser. If you do not do this, the browser may pull a page out of memory instead of going to the MSS Server to get the latest information. You may be shown old data. This problem is more likely to occur when you use the *Back* button on the browser.

---

## Home Page Structure

Figure 3-1 shows the MSS Server Home Page.

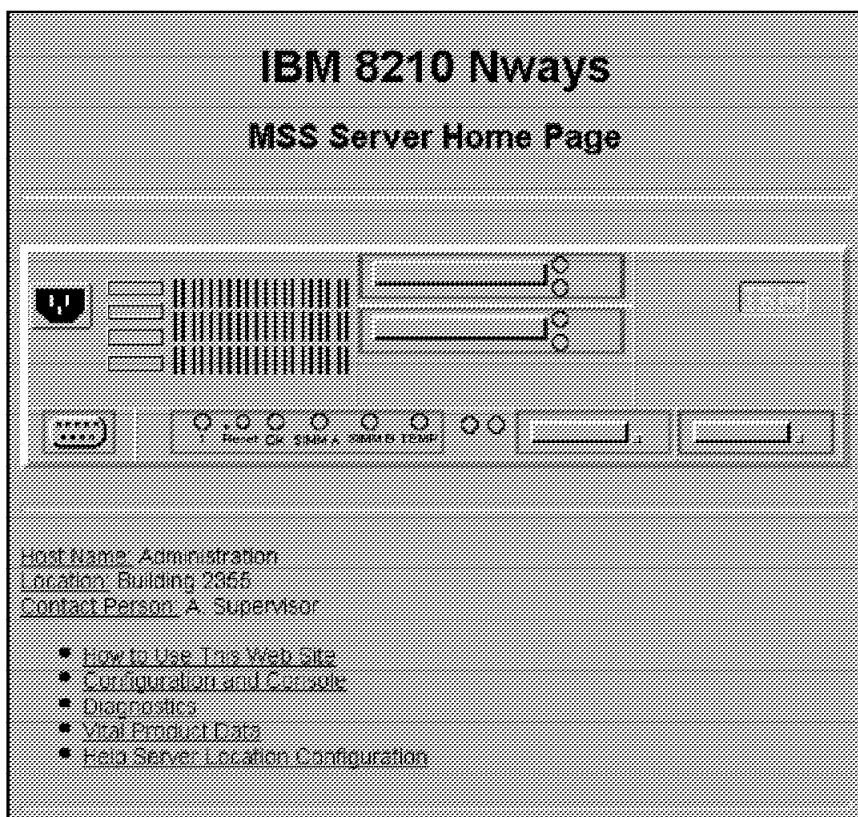

Figure 3-1. MSS Server Home Page

This Home Page provides a graphic that shows the status of the MSS Server. It indicates the current network interfaces installed and shows the status of each port (for example, installed, enabled, or disabled). The current state of each LED is also shown, as well as the indication of the devices that are installed in the two PCMCIA slots. If the Web browser supports dynamic refresh, then this page will automatically refresh itself approximately every 80 seconds. If you click any of these ports or interfaces, a more detailed description of its status will be shown on a separate Web page.

Click **How to use this Web Site** for instructions about using this site.

Click **Configuration and Console** to bring up the menu shown in Figure 3-2.

Click **Diagnostics** to bring up the menu shown in Figure 3-3.

Click **Vital Product Data** for information about the hardware and operational software. This panel, which is usually used for diagnostics, is not displayed here.

Click **Help Server Location Configuration** to set the path for the optional Help Server. You will need to set this path if you want to use the optional help files for the Web Browser interface.

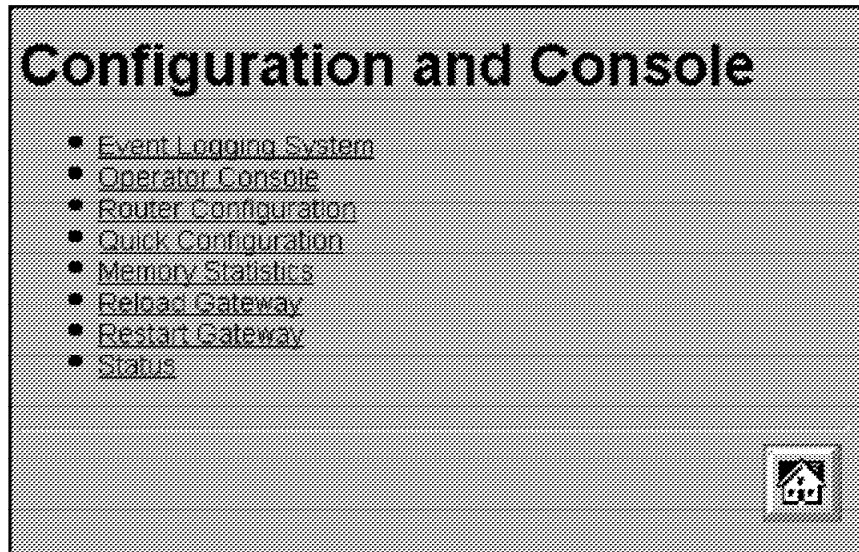

Figure 3-2. Configuration and Console Page 1

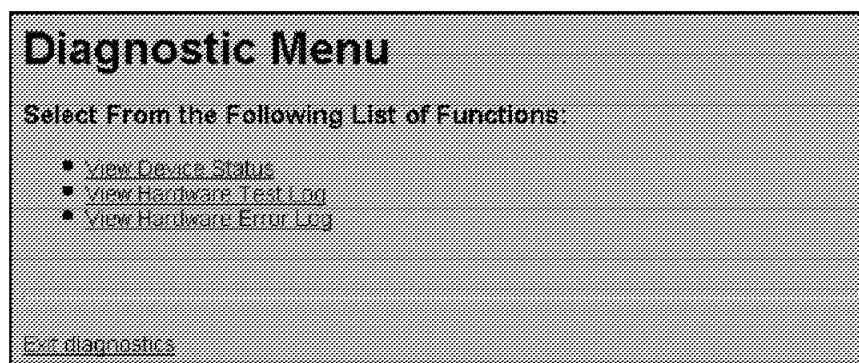

Figure 3-3. Diagnostic Menu

## Configuration and Console Menu

This menu can lead you into various aspects of configuration. If you are starting with quick configuration, click **Quick Configuration**. Figure 3-4 shows the quick configuration menu.

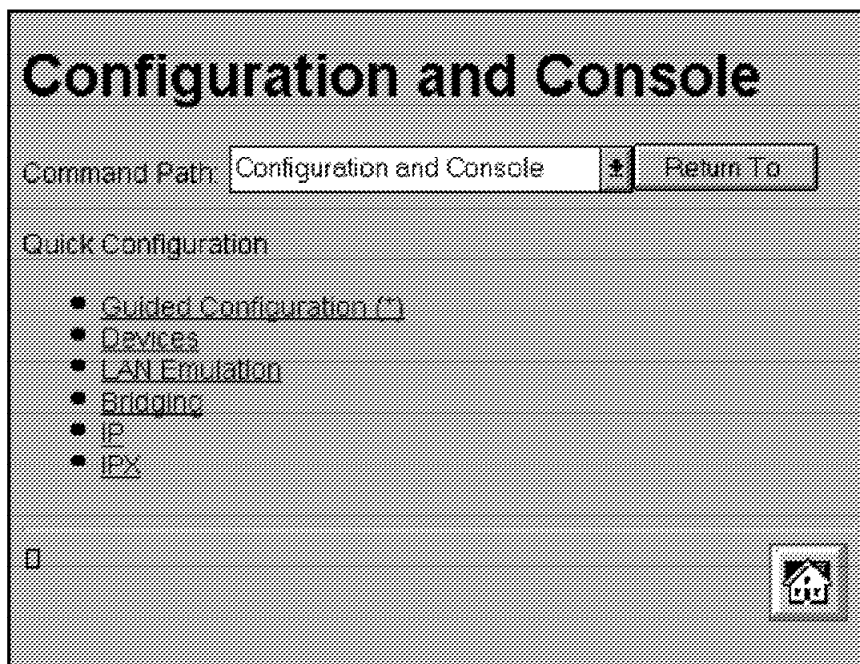

Figure 3-4. Configuration and Console Page 2

See “Quick Configuration Using the Web Browser Interface” on page 3-5 for information about quick configuration and guided configuration.

---

## Event Logging System

One of the links on the Configuration and Console page 1 is to the Event Logging System (ELS). The ELS display is similar to the one provided on the command line interface. On the Web interface, going into the ELS will display the most recent events stored in the system memory. In order to get future updates, press the Reload button on your browser. For more details about the ELS message facility, refer to the *Event Logging System Messages Guide*.

---

## Operator Console

The console monitoring interface provides real-time status information very similar to that offered in the command line interface. The menus from the command line interface are presented as a hierarchy of Web links that can easily be traversed with the click of a mouse button. It is possible to jump back several levels in the hierarchy with a single push of a button.

---

## Router Configuration

**Important:** Exercise caution when you use the Web browser to change configuration parameters. Changes to the configuration that are made using the Web browser are written directly to static random access memory (SRAM). You can make unintentional configuration changes that do not take effect until the MSS Server is reset. To check that you have the correct parameters, look over the settings for any parameters that you have configured before submitting them.

The Web interface greatly simplifies the configuration of network and protocol parameters. In many cases where it is necessary to remember the individual network numbers on the command line interface, those options are now all presented as menu options on the Web. Also, the Web interface uses the graphical features available to it, such as the use of picklists, selection lists, radio buttons, and checkboxes.

If a particular configuration option needs to prompt you for answers to several questions, those questions are now presented on a single Web page. After all of the questions are filled in, you should press the *Submit* button to send the data back to the MSS Server for validation.

The hierarchy of the Web browser interface is very similar to that of the command line interface; for more information about this hierarchy, please refer to both volumes of the *Command Line Interface User's Guide and Protocol Reference*.

---

### History Function

The Web Configurator uses a selection list and a *Return to* button to provide an advanced history function. Depending upon your choice of HTML browser, a picklist, choice box or pull-down list box will be displayed. This list of selections contains the names of the pages visited under the current branch of the software structure. To return to a previously visited page within the current command pathway, select that entry from the list and click the *Return To* button.

---

### Help System for the Web Browser Interface

Optional, free of charge, help files for the Web Browser interface can be downloaded from the Web. Use of the help button located at the bottom of Web Browser configuration panels requires the installation of these help files.

For download instructions and additional information about the help files, point your browser to URL <http://www.raleigh.ibm.com/nes/nesswite.htm>

---

### Quick Configuration Using the Web Browser Interface

**Note:** This section is most helpful when it is used while you are viewing the MSS Server Web interface.

Quick Configuration for the MSS Server using the Web interface is divided into the following steps:

- Guided configuration
- Devices
- LAN Emulation
- Bridging
- IP
- IPX

### Guided Configuration

To view the individual steps that are required for quick configuration, select **Guided Configuration** from the menu on Configuration and Console page 2, shown in Figure 3-4 on page 3-4. On each step, you will be presented with a link that allows you to skip to the next step. When you submit the form for a step, the results page will contain a link that takes you to the next step in the guided configuration. The results page in the last step of the guided configuration contains a link to take you back to the home page.

If you complete the guided configuration, you will have been through every step of a quick configuration. If you want to change only certain aspects of a quick configuration, use each of the separate steps. For example, to change only LAN emulation parameters, select that step.

### Devices

Selecting **Devices** presents a list of the currently configured devices, which are the ATM adapters. Click on the **Submit** button to add an ATM device using the next available network and slot numbers. A **Submit** button is included on the results page if there is still room to add more devices. Click on it again to add another ATM device. A **Submit** will not be included on the results page once all the available slots have been filled, so it is impossible to attempt to add too many devices.

When you are done with this step, you will have added all physical ATM devices to the configuration.

### LAN Emulation

Selecting **LAN Emulation** presents a form that allows the LAN Emulation Configuration Server (LECS), LAN Emulation Server (LES), Broadcast Manager and LAN Emulation Client (LEC) to be configured for each ATM device that has been added.

When multiple ATM devices are added, radio buttons are presented that allow you to configure the ATM device that the LECS will use.

For each ATM device that has been added, you have the option of adding one emulated token ring, one emulated Ethernet, neither or both. Each emulated LAN (ELAN) is added by selecting its associated checkbox. For each ELAN that is configured, you must specify the name and selector to be used by the LES. You can also specify which types of broadcast management will be performed by selecting the appropriate checkboxes for:

- IP
- IPX
- NetBIOS
- Source Routing (token-ring ELANs only)

When you click on the Submit button, all of the LAN Emulation components are configured based on the input from the form. A LES is added for each ELAN. The LESs are configured to use the burned-in ESI of the ATM device along with the selector byte that you previously specified for the ELAN.

Broadcast management is configured for each ELAN as specified by the checkboxes from the form.

A LE client is also added for each ELAN. The clients are configured to request the ELAN name configured from the form and to use the burned-in ESI of the ATM device along with a selector byte automatically generated by the system.

The LECS is configured with policies for the ELAN by name and for the ELAN by type. ELAN by name is given the highest priority. When a LE client joins and specifies one of the configured ELAN names, it will be sent to the appropriate LES. Clients joining an ELAN by type will be sent to the LES of the desired type that is on the ATM device that the LECS is configured to use.

When the form is submitted by clicking on the Submit button, LAN emulation is configured according to the submitted data and the results are displayed on a new page. Quick configuration allows you to configure only one ELAN per ATM device. If you need to configure additional ELANs, click on the links that are included on this page to provide links to the more detailed configuration pages for the LECS and each LES and LE client.

When you are done with this step, all ELAN interfaces have been added to the configuration. This step combined with the previous step provides the network interfaces necessary for performing bridging, IP, and IPX configuration in the subsequent steps.

### Bridging

Selecting **Bridging** presents a form that allows bridging to be configured on each network interface that can support bridging. You can also configure the bridge parameters required for source route bridging, which include the bridge number and the virtual segment number. For each emulated token-ring interface capable of bridging, you are given the option to enable source routing and to configure a segment number if source route bridging is enabled.

When the form is submitted by clicking on the Submit button, transparent bridging is automatically enabled for all token-ring and Ethernet LE clients. Source route bridging is enabled on any token-ring LE client with the checkbox selected. Bridging can be done only on the LE clients and not directly on the ATM devices. The results are displayed on a new page.

### IP

Selecting **IP** presents a form that allows IP to be configured on each network interface. For each interface, you can enable IP by selecting the associated checkbox. If you enable IP, you must provide an IP address and mask using the dotted decimal format. The IP address and the subnet mask are the only parameters required to enable IP on an ELAN.

If you enable IP on an ATM device, you are actually configuring Classical IP (RFC 1577). In this case, you must select a radio button to choose between a *client-only* configuration or a *client and server* configuration. If you select *client-only*, then you must specify the 20-byte ATM address of the remote ARP server that the client will use. If you select *client and server*, then you must specify the selector. The burned-in ESI and the specified selector make up the portion of the ATM address that can be configured by the user.

**Note:** For quick configuration, the burned-in ESI is the only choice. You are required to set the selector.

When the form is submitted by clicking on the Submit button, IP is configured according to the submitted data and the results are displayed on a new page.

## IPX

Selecting **IPX** presents a form that allows IPX to be configured on each network interface that can support IPX. Each eligible interface can be enabled for IPX by selecting the associated check box. If you enable IPX, you must configure a network number and select the encapsulation type to be used by choosing the appropriate value from the select list presented for each interface.

When you submit the form by clicking the Submit button, IPX is configured according to the submitted data and the results are displayed on a new page.

---

## An Example of Quick Configuration Using the Web Browser Interface

The following procedure shows how to use Quick Configuration to configure LAN emulation using the Web Browser interface:

1. Connect to the MSS Server using a SLIP connection. Configure your SLIP stack to use 10.1.1.2 as the IP address of the MSS Server and 10.1.1.3 as your IP address.
2. Open the following URL: <http://10.1.1.2/>
3. From the MSS home page, click **Configuration and Console**.
4. From Configuration and Console click **Quick Configuration**.

- a. Click **LAN Emulation**.

Change ELAN names if desired, then click **Submit**.

LES/BUS, LEC and LECS are now configured for one Token-Ring and one Ethernet ELAN. Either or both ELANs can be omitted if desired.

Select **Quick Configuration** from the Command History and click **Return to**.

- b. Click **IP**.

Enable IP on the desired interfaces. IP must be enabled on at least one interface. The choices are:

- Enabling Classical IP on the ATM adapter interface
- Enabling IP on each of the ELAN interfaces defined in the previous step

Change the IP addresses and masks to appropriate values for your network.

If Classical IP is configured as a client only, the ATM address of the ARP Server must be entered.

Click **Submit**.

IP is now configured on the specified interfaces.

Click the home icon at the bottom of the screen.



5. From the MSS home page, click **Configuration and Console**.

From Configuration and Console click **Router Configuration**

Click **RELOAD**.

Select **Yes** and click the **Submit** button to restart the MSS Server.

The MSS Server will now be accessible from the ATM network using the IP addresses that were specified in step 4b on page 3-8.



---

## Chapter 4. MSS Server Voice/Data/Fax Modem Support

A PCMCIA Voice/Data/Fax Modem is shipped with the MSS Server in the U.S. and Canada; in most other countries, the PCMCIA Data/Fax Modem is shipped. Check with your IBM representative if you want to determine whether you will receive the Data/Fax Modem.

If you do not use the Voice/Data/Fax Modem or the Data/Fax Modem, you can purchase a modem and attach it externally to the EIA-232 port for remote access to the MSS Server. Information about the types of modem supported is found in the *IBM Multiprotocol Switched Services (MSS) Server Introduction and Planning Guide*, GC30-3820.

---

### Installation of the Voice/Data/Fax Modem

Follow these steps to install the Voice/Data/Fax Modem:

1. Use the eject button to remove the Data/Fax Modem, if it is present.
2. Insert the Voice/Data/Fax Modem in the available PCMCIA slot.

The Voice/Data/Fax Modem is hot-pluggable. It will re-initialize when it is inserted in the PCMCIA slot.

If you use the serial service port at the same time that you use the Voice/Data/Fax Modem or the Data/Fax Modem, you need an analog telephone line for each connection.

---

### Data/Fax Modem

This PCMCIA modem allows remote connection of a workstation to the MSS Server over telephone lines to access the command line interface, the Web browser interface, or the Configuration Program. You must use serial line Internet protocol (SLIP) over the telephone line to access the Configuration Program.

In addition, it can be configured to fax a report whenever the MSS Server sends an alert. See "Voice Pager Messages" on page 4-4 for an example of the kinds of alerts that the Data/Fax Modem sends.

Neither the Data/Fax Modem nor the Voice/Data/Fax Modem require any special configuration.

---

### MSS Server Voice Access Using the Voice/Data/Fax Modem

When you place a voice call to the Voice/Data/Fax Modem, you will hear a voice menu. Items on this menu will allow you to access the MSS Server and to exercise limited control over it. The four capabilities enabled by the Voice/Data/Fax Modem are:

1. Performance monitoring
2. Remote problem determination
3. Network monitoring
4. Limited configuration

## MSS Server Voice/Data/Fax Modem Support

The Voice/Data/Fax Modem lacks speech synthesis, so verbal output is limited to the capabilities of the prerecorded voice files. The model implemented for the MSS Server uses a fax machine as an output device and the telephone primarily as an input device. You press a touch tone telephone key to give information to the MSS Voice Response Unit.

As a result, most of the information obtained from the Voice/Data/Fax Modem is in the form of faxed reports. Files containing the report information will be constructed and passed to the fax function.

### Performance Information

A menu option that provides selected performance information and predefined performance and configuration reports is available using the Voice/Data/Fax Modem.

### Remote Service

For remote service, the Voice/Data/Fax Modem provides a menu of activities that the caller can utilize, including:

- Resetting the MSS Server
- Reviewing pager log entries
- Reviewing non-volatile memory log entries
- Obtaining a report on field replaceable unit (FRU) status

### Network Monitoring

Network monitoring is generally provided using SNMP input that is handled by a network manager. However, the Voice/Data/Fax Modem provides some limited ability to access or retrieve information for the caller. The following menus are offered:

- Network management statistics and information
- Predefined reports available using fax

### Configuration

The Voice/Data/Fax Modem allows you to change a limited number of configuration parameters. See “Option 5—Configuration” on page 4-7 for more information.

**Important:** Exercise caution when you use the voice menu to change configuration parameters. Changes to the configuration that are made using the voice menu cause the current configuration to be written directly to static random access memory (SRAM). When these changes are written to SRAM, any temporary changes that have been made using the Web browser interface or the command line interface are also written to SRAM and become part of the active configuration. Before you use the voice menu to change any parameters, you should make sure that all temporary parameter settings are acceptable.

---

## MSS Server Voice Pager Support

The voice pager is included as a way to alert you that there is a problem, for example, that the MSS Server has become overheated or has had to reload due to an unrecoverable error of the software.

The voice pager function can call a telephone number and deliver a voice message describing a problem. The pager attempts to detect that the telephone has been answered before it speaks the message. It can speak its message to a person, a voice mail system, or a voice paging service. It cannot determine which of these methods was used to answer the telephone.

You can configure multiple telephone numbers to receive the pager messages. The pager will try them in sequence until one answers. Whenever one of the numbers is answered, the pager message is considered delivered.

## Voice Pager Configuration Parameters

You can control the sending of outbound telephone call page messages. These are the paging parameters:

- PagerNum character strings

These are the telephone numbers to call for the outbound voice messages generated by problem conditions. The telephone numbers will be called until one answers so that the voice message can be delivered. You can have from zero to 4 numbers. If there are zero telephone numbers, outbound page messages will not be attempted.

- Quantity of telephone numbers
  - Maximum 4
  - Minimum 0
  - Default 0 (no telephone numbers)
- Length of the telephone number
  - Maximum 64
  - Minimum 0
  - Default 0 (no telephone number)
- Content of the telephone number

The telephone numbers can contain digits 0 through 9 and commas. A comma will cause the outbound dialer to pause for 2 seconds. This feature is often used when dialing an outside line or calling a second number.

- RetryInterval integer

High-severity voice page messages will be sent until the machine is called by the receiver of the message and the receipt of the page message is acknowledged. This parameter gives the time in minutes to wait before resending the voice page message. This parameter is known as the *nag interval*. If this number is zero, high-severity page messages will be sent only once.

- Quantity of minutes in the retry interval

This parameter specifies the length of time during which the pager will continue to resend high-severity voice messages.

- Maximum 840 (24 hours)
- Minimum 0
- Default 60 (1 hour)

### Voice Pager Messages

All page messages start with the same prefix:

```
This is a message from an IBM MSS Server serial number nnnnnnnn
```

The page prefix message will be followed by a unique problem message. Currently, there are three problem messages that the pager will deliver:

1. The MSS Server has re-booted due to a fatal error.
2. The MSS Server is over recommended operating temperature. Further temperature increases may cause the MSS Server to shut down.
3. The MSS Server has exceeded maximum operating temperature and is shutting down.

### Maintenance Log

The maintenance log keeps a record of fax and paging activity. The log entries are timestamped. The log can be sent to a fax machine for viewing.

### Maintenance Log Configuration Parameter

You can control the size of the maintenance log. This log is a wrap-around file that never changes size. If the file is defined to have 100 entries, it will be created to contain 100 entries. When the log is filled, the oldest log entry will be replaced. Each log file entry takes approximately 250 bytes of disk space.

The configuration parameter is an integer—`MaintenanceLogSize`— that specifies the number of log entries contained in the file.

- Maximum 4096
- Minimum 32
- Default 64 (16 000 bytes disk space)

---

### Voice/Data/Fax Modem Menu Items

When the Voice/Data/Fax Modem receives a call, it requests that the caller press the pound (#) key. If the # is pressed, the Voice/Data/Fax Modem recognizes that this is a voice call. The voice menu takes control and requests the MSS Server personal identification number (PIN).

**Note:** The default value for this PIN is 8210001. Whichever PIN is configured first is the supervisory PIN. If only one PIN is configured, it is the supervisory PIN. If you configure one PIN and delete 8210001, then the PIN that you have configured becomes the supervisory PIN.

Each additional PIN that is configured is placed in a sequence. For example, if you configured three PINs, and then deleted the default PIN and the first PIN, the second PIN would become the supervisory PIN.

**Note:** At this point, the functions offered by the Voice/Data/Fax Modem are the same as certain functions that you can access using the command line interface. Refer to the two volumes of the *Command Line Interface User's Guide and Protocol Reference* for more information about these functions. In the description of the Voice/Data/Fax Modem menu that follows, keywords from the command line

interface are provided to help you find the relevant information in the *Command Line Interface User's Guide and Protocol Reference*.

The main voice menu offers the following options:

<b>Voice Message</b>	<b>Function</b>
Press <b>1</b> to reset	MSS Server Reset
Press <b>2</b> for operational statistics	Status and statistics
Press <b>3</b> for router protocol reports	Reports
Press <b>4</b> for event log reports	Event logs
Press <b>5</b> for configuration options	Configuration
Press <b>6</b> for device presence and status	Device presence and status report
Press <b>7</b> to resend last fax report	Resend fax
Press <b>8</b> for disconnect call	Disconnect
Press <b>9</b> for repeat menu	Repeat menu

The options are repeated approximately every 15 seconds until a valid entry is made or until the call has been terminated.

### Option 1—Reset

When you use the Voice/Data/Fax Modem to perform a reset, you are prompted to confirm that you want to perform the reset. If you do not confirm the reset, the main menu is repeated. If you do confirm the reset, the voice message responds, "The MSS Server will be reset." Your connection to the MSS Server is then broken and the reset occurs.

**Attention:** A reset interrupts the function of the MSS Server for up to 90 seconds. Be sure that the network is prepared for the interruption.

### Option 2—Status and Statistics

Statistics are available from several sources. The following general MSS Server statistics will be packaged as a single report and faxed upon request.

1. Status of Micro Operating System (MOS) processes (as reported by the *STATUS* keyword from the MOS operator console)
2. Memory
  - Number of bytes (as reported by the *MEMORY* keyword from the MOS operator console)
  - Heap and buffer memory (as reported by the *MEMORY* keyword from the configuration gateway [CGW] console)
  - Network interface buffers (as reported by the *BUFFER* keyword from the CGW console)
3. Interface (as reported by the *INTERFACE* keyword from the CGW console)
4. Network (as reported by the *STATISTICS* keyword from the CGW console)
5. Uptime (as reported by the *UPTIME* keyword from the CGW console)
6. Queue length (as reported by the *QUEUE* keyword from the CGW console)
7. Error counts (as reported by the *ERROR* keyword from the CGW console)
8. Event Logging Statistics (as reported by the *STATISTICS* keyword from the *EVENT* keyword from the CGW console)

9. Gateway configuration (as reported by the *CONFIGURATION* keyword from the CGW console)
10. Log level (as reported by the *LOG* keyword from the CGW console)
11. Code image and configuration information (available and active)
12. Thermal status of the hardware

When you request *Status and statistics*, you will hear one of these two messages: "MSS Server statistics will be faxed." or "Statistics not available." If you do not disconnect the call, the voice menu starts again.

### Option 3—Reports

You can also request protocol reports other than statistics from the voice menu.

- IP

The following IP information will be provided in a report:

- Access control list (as reported by the *ACCESS* keyword from IP from PROTOCOL on the CGW console)
- Address cache (as reported by the *CACHE* keyword from IP from PROTOCOL on the CGW console)
- Counter values (as reported by the *COUNTERS* keyword from IP from PROTOCOL on the CGW console)
- Interface addresses (as reported by the *INTERFACE* keyword from IP from PROTOCOL on the CGW console)
- Table, buffer, cache sizes (as reported by the *SIZES* keyword from IP from PROTOCOL on the CGW console)
- Static routes (as reported by the *STATIC* keyword from IP from PROTOCOL on the CGW console)

- IPX

- Interface addresses (as reported by the *CONFIG* keyword from IPX from PROTOCOL on the CGW console)
- Cache information (as reported by the *CACHE* keyword from IPX from PROTOCOL on the CGW console)
- Counters (as reported by the *COUNTERS* keyword from IPX from PROTOCOL on the CGW console)

- LAN emulation (as reported by the *LIST* keyword from LE-SERVICES from ATM from NETWORK on the CGW console)

- LES/BUS Pairs (as reported by the *LIST* keyword from LE-SERVICES from ATM from NETWORK on the CGW console; an ATM interface must have been selected)

- Bridging

- Brief universal summary of the state of the bridge (as reported by the *LIST BRIDGE* keywords from ASRT from PROTOCOL on the CGW console)

When you choose *Reports*, you will be prompted to select the protocol report option. Select IP, IPX, LAN Emulation, or bridging. Then you will hear either "Report not available" or "MSS Server Protocol Report will be faxed." If you do not disconnect the call, the voice menu starts again.



## Option 4—Event Logs

The MSS Server maintains several logs. Information contained there may be of interest to the systems administrator.

- Non-volatile memory error log (accessed through the firmware log interface)
- Operational diagnostics log (using the Diagnostics Control System interface)
- Pager log entries (new)

**Note:** MSS Server trouble reports (critical problems) can be automatically faxed. These reports are not part of the voice menu structure.

When you choose *Event logs*, you will hear the voice message “MSS Server event logs will be faxed.” or “Event logs not available.” If you do not end the call, the voice menu starts again.

## Option 5—Configuration

The Voice/Data/Fax Modem provides a limited configuration input capability. You can access the following configuration options using the Voice/Data/Fax Modem:

- Fax telephone number (up to 64 digits)
- Thermal shutdown mode (enabled or disabled)—Standalone MSS Server only
- Auto-Fax for trouble reports (On or Off)
- Pager telephone numbers (up to 64 digits)
- Personal identification number (PIN) maintenance

The functions of the Voice/Data/Fax Modem are protected by up to 10 personal identification numbers. Any person with knowledge of the supervisory PIN can add, delete, or modify PINs. The supervisory PIN is the first one in the list of 10 allowed PINs.

**Note:** The Voice/Data/Fax Modem is shipped with a default supervisory PIN of 8210001.

When you choose *Configuration*, you will hear the voice message “Change Voice/Data/Fax Modem PINs.” Then, you are prompted to add, delete, or change the PINs. When you are done, if you do not disconnect the call, the voice menu starts again.

## Option 6—Device Presence and Status Report

Remote service is normally provided over the TTY or SLIP interface. In addition to the reporting and reset capabilities previously described, you can request a report that provides detailed device presence and status (DPS) information. This information can be obtained in a verbal message or in a more detailed fax report.

The verbal message begins with a statement of the number of recognized devices followed by a statement of the number of those that are enabled. If any are disabled, it will then state the number disabled. Finally, if any are out of service for other reasons, it will state the number of devices in non-operational states other than disabled.

Device presence and status fax reports contain the same information that is accessible when you select the *DIAGS* keyword from the MOS operator control and then select Option 1, Device Status, from the DIAGS menu.

## MSS Server Voice/Data/Fax Modem Support

You can also obtain this information from the Web browser interface by selecting *Diagnostics* from the main menu.

### Option 7—Resend Last Fax Report

You should request this option before you select another fax report because the previous fax report file is recreated for each call. If you make this request before you request the next fax report, the file for the previous call is retained and any additional requests will be appended to it.

### Option 8—Disconnect Call

You can request that the modem disconnect the call. When you choose *Disconnect call*, you will hear the voice message “Are you sure you want to disconnect?” and you will be prompted to respond. If you do not disconnect the call, the voice menu starts again.

### Option 9—Repeat Menu

You can request a repetition of the menu.

## Chapter 5. The OPCON Process and Commands

This chapter describes the OPCON process and includes the following sections:

- “What is OPCON?”
- “Accessing the OPCON Process” on page 5-2
- “OPCON Commands” on page 5-3

### What is OPCON?

The Operator Console process (OPCON) is the root-level process of the router software user interface. The main function of OPCON is to control which processes are connected to consoles. OPCON fits into the router software structure as shown in Figure 5-1. Using OPCON commands, you can:

- Manipulate the output from a process
- Change the intercept character
- Display information about router memory usage
- Restart the router software
- Reload the router software (reboot)
- Telnet to other routers or hosts
- Display status information about all router processes
- Communicate with processes at the secondary level
- Escape to the MOS system debugging tool

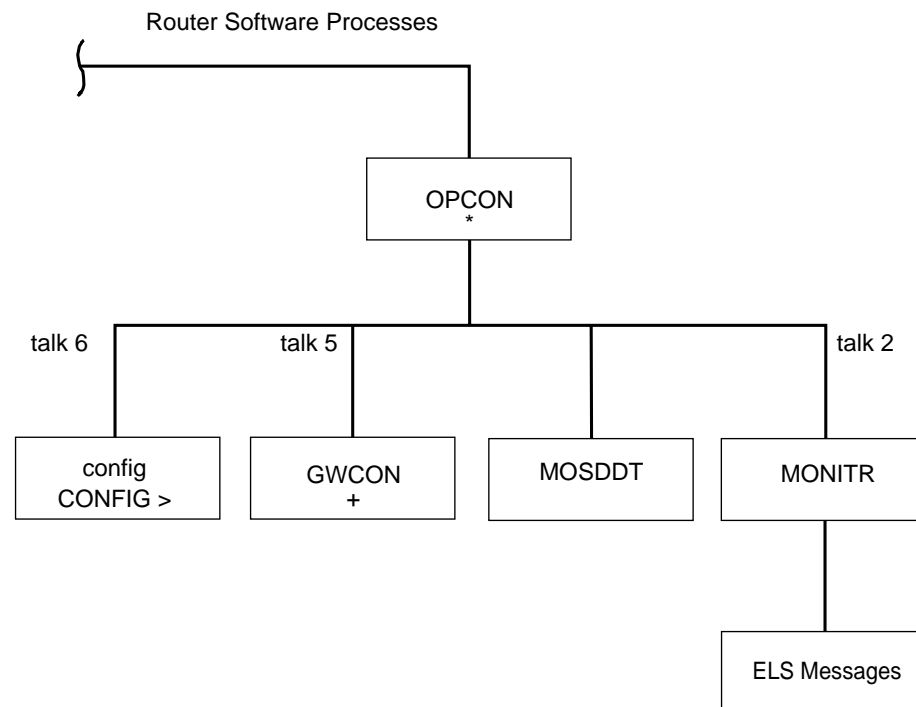

Figure 5-1. OPCON in the Router Software Structure

### Accessing the OPCON Process

When you start the router for the first time, a boot message appears on the console. Then the OPCON prompt (\*) appears on the console, indicating that you are in the OPCON process and can begin entering OPCON commands.

When you access OPCON from a remote terminal, you access the ROPCON (Remote Operator Console) process. ROPCON and OPCON are functionally the same.

The OPCON process allows you to configure and monitor all of the router's operating parameters. While in the OPCON process, the router is forwarding data traffic. When the router is booted and enters OPCON, a copyright logo and an asterisk (\*) prompt appears on the locally attached console terminal. This is the OPCON (OPerator's CONsole) prompt, the main user interface that allows access to second-level processes.

Some changes to the router's operating parameters made while in OPCON take effect immediately without requiring reinitializing of the router. If the changes do not take effect, use the reload command at the \* prompt.

At the \* prompt, there is an extensive set of commands that you can enter to check the status of various internal software processes, monitor the performance of the router's interfaces and packet forwarders, and configure various operational parameters.

## OPCON Commands

This section describes the OPCON commands. Each command includes a description, syntax requirements, and an example. The OPCON commands are summarized in Table 5-1 on page 5-4. To use them, access the OPCON process and enter the appropriate command at the OPCON prompt (\*).

Figure 5-2 shows the OPCON Command Tree.

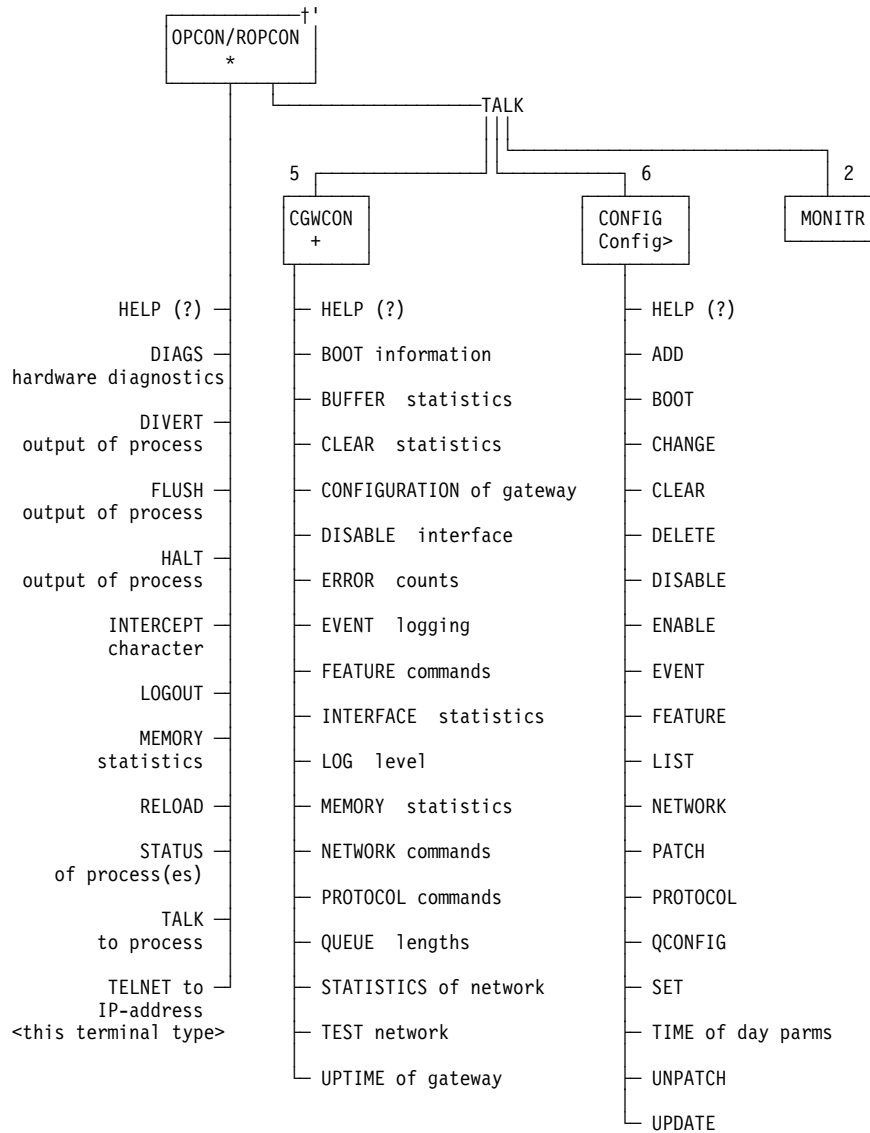

Figure 5-2. OPCON Command Tree

<i>Table 5-1. OPCON Commands</i>	
<b>Command</b>	<b>Function</b>
<b>? (Help)</b>	Lists all the OPCON commands.
<b>Diags</b>	Displays device status and the contents of the hardware test log and the hardware error log.
<b>Divert</b>	Sends the output from a process to a console or other terminal.
<b>Flush</b>	Discards the output from a process.
<b>Halt</b>	Suspends the output from a process.
<b>Intercept</b>	Sets the OPCON default intercept character.
<b>Logout</b>	Logs out a remote console.
<b>Memory</b>	Reports the router's memory usage.
<b>Reload</b>	Reloads the router software.
<b>Status</b>	Shows information about all router processes.
<b>Talk</b>	Connects to another router process and enables the use of its commands.
<b>Telnet</b>	Connects to another router.

## ? (Help)

Use the **? (help)** command to list the commands that are available from the current prompt level. You can also enter a **?** after a specific command name to list its options.

**Syntax:** ?

**Example:** ?

```

DIAGS diagnostics
DIVERT output from process
FLUSH output from process
HALT output from process
INTERCEPT character is
LOGOUT
MEMORY statistics
RELOAD
STATUS of process(es)
TALK to process
TELNET to IP Address (this terminal type)
    
```

## Diags

Use the **Diags** command to display the Diagnostic Main Menu. The diagnostic menus allow you to enable, disable and test hardware adapters or ports. Diagnostic menus have on-screen help for the various options and status information that is available.

You can use the “b” (back) key to return to any previous menu. Use the “e” (exit) key to exit the diagnostics and return to the OPCON command prompt.

**Syntax:** diaags

**Example:** diags

## Divert

Use the **divert** command to send the output from a specified process to a specified terminal. This command allows you to divert the output of several processes to the same terminal to simultaneously view the output. The **divert** command is commonly used to redirect MONITR output messages to a specific terminal. The router allows only certain processes to be redirected.

After entering the command, enter the PID and tty# (number of the output terminal). To obtain these values, use the OPCON status command. The terminal number can be the number of either the local console (tty0) or one of the remote consoles (tty1, tty2). The following example shows Event Logging System messages generated by the MONITR process (2) being sent to a remote console *tty1* (1).

Event messages are displayed immediately even though you may be in the middle of typing a command. The display and keyboard have separate buffers to prevent command confusion. The following example shows the MONITR process connected to TTY1 after executing the **divert 2 1** command. If you want to stop the output, enter **halt 2**. The **halt** command is discussed at “Halt” on page 5-6.

```
* divert 2 1

* status
Pid Name      Status TTY  Comments
 1 COpCon     IOW  TTY0 gzs
 2 Monitr    IDL  TTY0
 3 Tasker    RDY  --
 4 MOSDBG    DET  --
 5 CGWCon    DET  --
 6 Config    DET  --
 7 ROpCon    IDL  TTY1
 8 ROpCon    RDY  TTY2 j1g@128.185.40.40
 9 WEBCon    IDL  --
```

**Syntax:** `divert pid tty#`

**Example:** `divert 2 1`

## Flush

Use the **flush** command to clear the output buffers of the MONITR process. This command is generally used prior to displaying the contents of the MONITR's FIFO buffer to prevent messages from scrolling off the screen. Accumulated messages are discarded.

The router allows only certain processes to be redirected. To obtain the *pid* and *tty#*, use the OPCON **status** command. As you can see in the following example, after executing the **flush 2** command, the output of the MONITR process is sent to the SNK (it has been flushed).

**Syntax:** `flush pid`

**Example:** `flush 2`

## OPCON Commands

```
* flush 2

* status
  Pid  Name      Status TTY  Comments
  1    COpCon   IOW   TTY0 gzs
  2    Monitr  IDL   SNK
  3    Tasker  RDY   --
  4    MOSDBG  DET   --
  5    CGWCon  DET   --
  6    Config  DET   --
  7    ROpCon  IDL   TTY1
  8    ROpCon  RDY   TTY2 jlg@128.185.40.40
  9    WEBCon  IDL   --
```

## Halt

Use the **halt** command to suspend all subsequent output from a specified process until the **divert**, **flush**, or **talk** OPCON command is issued to the process. The router cannot redirect all processes. **Halt** is the default state for output from a process. To obtain the PID for this command, use the OPCON **status** command. As you can see in the following example, after executing the **halt 2** command, the MONITR process is no longer connected to TTY1. Event messages no longer appear.

**Syntax:** halt *pid*

**Example:** halt 2

```
* halt 2

* status
  Pid  Name      Status TTY  Comments
  1    COpCon   IOW   TTY0 gzs
  2    Monitr  IDL   --
  3    Tasker  RDY   --
  4    MOSDBG  DET   --
  5    CGWCon  DET   --
  6    Config  DET   --
  7    ROpCon  IDL   TTY1
  8    ROpCon  RDY   TTY2 jlg@128.185.40.40
  9    WEBCon  IDL   --
```

## Intercept

Use the **intercept** command to change the OPCON intercept character. The intercept character is what you enter from other processes to get back to the OPCON process. The default intercept key combination is **Ctrl P**.

The intercept character **must** be a control character. Enter the ^ (shift 6) character followed by the letter character you want for the intercept character.

**Attention:** Do not set the intercept character to the return key or to a printable character. If you change the OPCON intercept character from the default, **Ctrl-P**, to one of the Command History control characters, **Ctrl-B**, **Ctrl-F**, **Ctrl-R**, or **Ctrl-N**, the OPCON intercept character will take priority.

For example, if you change the intercept character to **Ctrl-F**, then **Ctrl-F** will not retrieve Forward in the Command History, but will instead return to the OPCON prompt (\*). See "Command History for GWCON and CONFIG Command Line" on page 1-20 for information on how to access previously entered GWCON or CONFIG commands.



**Syntax:** `intercept character`

**Example:** `intercept ^u`

From this example, you will have an intercept character of **Ctrl U**.

## Logout

Use the **logout** command to terminate the current session for the user who enters the logout command. If the console login is enabled, this command will require the next user to log in using an authorized userid/password combination. If the console login is not enabled, the OPCON prompt appears again.

**Syntax:** `logout`

**Example:** `logout`

## Memory

Use the **memory** command to obtain and display information about the router's global heap memory usage. The display helps you to determine if the router is being utilized efficiently. For an example of memory utilization, see Figure 5-3.

**Syntax:** `memory`

**Example:** `memory`

Number of bytes: Busy = 319544, Idle = 1936, Free = 1592

*Busy* Specifies the number of bytes currently allocated.

*Idle* Specifies the number of bytes previously allocated but freed and available for reuse.

*Free* Specifies the number of bytes that were never allocated from the initial free storage area.

**Note:** The sum of the Idle and Free memory equals the total available heap memory.

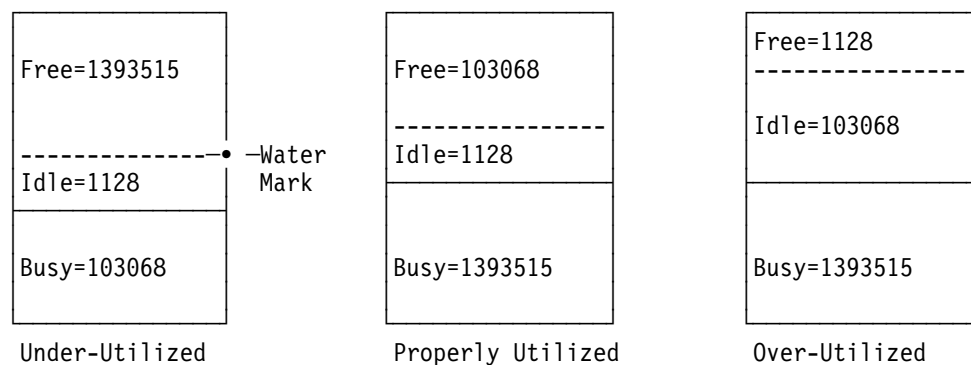

Figure 5-3. Memory Utilization

## Reload

Use the **reload** command to reboot the router by loading in a new copy of the router software. When you use this command from a remote console, you install a new software load without going to the router. This command executes the same functions as pressing the reset button except that the router will not dump (if so configured). Before the reload takes effect, you are prompted to confirm the reload.

**Syntax:** `reload`

**Example:** `reload`

Are you sure you want to reload the gateway (Yes or No)?

## Status

Use the **status** command to display information about all router processes. By entering the PID after the **status** command, you can select to look at the status of only the desired process. The following example shows the total status display.

**Syntax:** `status pid`

**Example:** `status`

Pid	Name	Status	TTY	Comments
1	COpCon	IOW	TTY0	
2	Monitr	IDL	--	
3	Tasker	RDY	--	
4	MOSDDT	DET	--	
5	CGWCon	IOW	--	
6	Config	IOW	TTY1	
7	ROpCon	IOW	TTY1	128.185.46.101
8	ROpCon	RDY	TTY2	128.185.46.104
9	WEBCon	IDL	--	

**Pid** Specifies the PID. This is the process to talk to or from OPCON, or it can be an argument to the STATUS command to request status information about a specific process.

**Name** Specifies the process name. It usually corresponds to the name of the program that is running in the process.

**Status** Specifies one of the following:

**IDL** Specifies that the process is idle and waiting for completion of some external event, such as asynchronous I/O.

**RDY** Specifies that the process is ready to run and is waiting to use the CPU.

**IOW** Specifies that the process is waiting for synchronous I/O, usually its expected standard input, to complete.

**DET** Specifies that the process has output ready to be displayed and it is either waiting to be attached to a display console or waiting to have its output diverted to a specified console.

**FZN** Specifies that the process is frozen due to an error. This usually means the process is trying to use a device which is faulty or incorrectly configured.

**TTYn** Specifies the output terminal, if any, to which the process is currently connected.

TTY0	Local console
TTY1 or TTY2	Telnet consoles.
SNK	Process has been flushed.
Two dashes (--)	Process has been halted.

*Comments*

Specifies the user's login IP address provided during login when a user is logged in using Telnet (ROpCon).

## Talk

Use the **talk** command to connect to other router processes, such as GWCON, MONITR, or CONFIG. After connecting to a new process, you can send specific commands to and receive output from that process. You cannot talk to the TASKER or OPCON process. See "Command History for GWCON and CONFIG Command Line" on page 1-20 for information on how to access previously entered GWCON or CONFIG commands.

To obtain the PID, use the OPCON **status** command. Once you are connected to the second-level process, such as CONFIG, use the intercept character, **Ctrl P**, to return to the \* prompt.

**Syntax:** `talk pid`

**Example:** `talk 5`

When using third-level processes, such as IP Config or IP, use the **exit** command to return to the second level.

## Telnet

Use the **telnet** command when you want to remotely attach to another router or to a remote host (*ip address*). The only optional parameter is the terminal type that you want to emulate.

A router has a maximum of five Telnet sessions: two servers (inbound to the router), and three clients (outbound from the router).

**Note:** To use Telnet in a pure bridging environment, you must enable Host Services.

**Syntax:** `telnet ip address terminal type`

**Example:** `telnet 128.185.10.30`

or

`telnet 128.185.10.30 23`

or

`telnet 128.185.10.30 vt100`

```
Trying 128.185.10.30 ...
Connected to 128.185.10.30
Escape character is '^'
```

If you are Telnetting to a non-existent IP address, the router displays:

```
Trying 128.185.10.30 ...
```

## OPCON Commands

To enter the Telnet command mode, type the escape character-sequence, which is **Ctrl-]**, at any prompt.

```
telnet>
```

If you telnet into a router,

- Press ← **Backspace** to delete the last character typed on the command line.  
**Note:** If you use a VT100t terminal, do not press ← **Backspace** because it inserts invisible characters. You must press **Delete** to delete the last character.
- Press **Delete** or **Ctrl U** at the telnet> prompt to delete the whole command line entry so that you can re-enter a command.

The Telnet command mode consists of the following subcommands:

<b>close</b>	Close current connection
<b>display</b>	Display operating parameters
<b>mode</b>	Try to enter line-by-line or character-at-a-time mode
<b>open</b>	Connect to a site
<b>quit</b>	Exit Telnet
<b>send</b>	Transmit special characters ('send ?' for more)
<b>set</b>	Set operating parameters ('set ?' for more)
<b>status</b>	Print status information
<b>toggle</b>	Toggle operating parameters ('toggle ?' for more)
<b>z</b>	Suspend Telnet
<b>?</b>	Print help information

The **status** and **send** subcommands have one of two responses depending on whether or not the user is connected to another host. For example:

Connected to a host:

```
telnet>  status
Connected to 128.185.10.30
Operating in character-at-a-time mode.
Escape character is ^].
telnet>  send ayt
```

**Note:** The send command currently supports only ayt.

Not connected to a host:

```
telnet>  status
Need to be connected first.
telnet>  send ayt
Need to be connected first.
```

Use the **close** subcommand to close a connection to a remote host and terminate the Telnet session. Use the **quit** subcommand to exit the **telnet** command mode, close a connection, and terminate a Telnet session.

```
telnet>  close

or

telnet>  quit

logout
*
```

---

## Chapter 6. The CONFIG Process and Commands

This chapter describes the CONFIG process and includes the following sections:

- “What is CONFIG?”
- “Quick Configuration” on page 6-3
- “Configuring User Access” on page 6-5
- “Entering and Exiting CONFIG” on page 6-6
- “CONFIG Commands” on page 6-7

---

### What is CONFIG?

The Configuration process (CONFIG) is a second-level process of the router user interface. Using CONFIG commands, you can:

- Set or change various configuration parameters
- Add or delete an interface to the hardware configuration
- Enter the Boot CONFIG command mode
- Enter the Quick Configuration mode
- Clear, list, or update configuration information
- Enable or disable console login and modem control
- Communicate with third-level processes, including protocol environments

CONFIG lets you display or change the configuration information stored in the router's non-volatile configuration memory. Changes to system and protocol parameters do not take effect until you reload the router software. (For more information, refer to the OPCON **reload** command in Chapter 5, “The OPCON Process and Commands”).

**Note:** The changes you make through CONFIG are retained in a configuration database in non-volatile configuration memory. They are retained during power-downs and are recalled when you restart the router.

CONFIG fits into the router software structure as shown in Figure 6-1 on page 6-2.

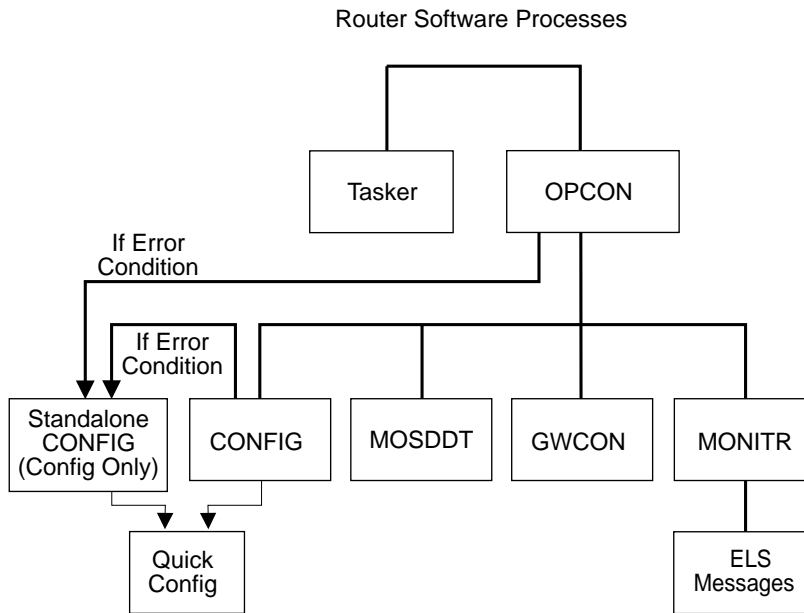

Figure 6-1. CONFIG in the Router Software Structure

The CONFIG command interface is made up of levels that are called modes. Each mode has its own prompt. For example, the prompt for the TCP/IP protocol is IP config>.

If you want to know the process and mode you are communicating with, press **Return** to display the prompt. Some commands in this chapter, such as the **network** and **protocol** commands, allow you to access and exit the various levels in CONFIG. See Table 6-2 on page 6-7 for a list of the commands you can issue from the CONFIG process.

## CONFIG-Only Mode

CONFIG-Only mode is a way to back out of a bad configuration that is causing the router to crash during start-up. Use the CONFIG-Only mode **only** to change devices or data links (that is, for unsupported devices) or to reduce memory use (for *no memory* crashes) such as routing table sizes, packet sizes, and receive buffer allocations.

**Note:** CONFIG-only is provided only for getting a subset of configuration commands when a config problem causes the router to panic, check, fatal, or bught. Do **not** use CONFIG-Only mode for general router configuration; many of the device-related commands are disabled in CONFIG-ONLY mode and some may cause a crash.

## Automatic Entry Into Config-Only Mode

CONFIG-Only mode is entered when the router detects a problem during operation or during router initialization.

Any of the following situations will cause the router to enter into CONFIG-Only mode:

- The software load does not match the device configuration. More particularly, an attempt is made to configure a device or data link that is unsupported by the software load.
- Deletion of all router interface information.

If the router entered into the configuration-only mode because an unsupported device has been configured:

- Change the device information to match the hardware installed in (and supported by) the router, or change the unsupported device to “null device.”
- Enter the **Reload** command from the `Config (only)>` prompt.
- The router will automatically enter into OPCON (\*).

## Manual Entry Into Config-Only Mode

To enter the config-only mode:

- Reload the router with no configuration.
- Reload the router with no interfaces configured.
- Reload the router with no protocols configured.

Any of the above will force the box into config-only.

Otherwise, the router will reboot. If boot information is missing, the software will load from the hard drive or flash memory.

See Chapter 8, “Accessing the Firmware from the Command Line Interface” for more detail.

During initial start-up, if no devices are configured the router comes up in CONFIG-ONLY mode. If no protocols are configured the router comes up in CONFIG-ONLY mode and automatically enters Quick Config. Quick Configuration is explained in the next section.

---

## Quick Configuration

Quick Configuration (Quick Config) provides a minimal set of commands that allow you to configure bridging protocols and routing protocols present in the router load.

**Attention** At least one network device must be configured before using quick config. To add a configuration use the “add device” command at the `config(only)>` or `config>` prompt.

Table 6-1 lists what Quick Config supports.

<i>Table 6-1. Quick Config Capabilities</i>	
<b>Bridging protocols</b>	<b>Routing Protocols</b>
ATM	STB, SRT, SRB, SR/TB

The Quick Config complements the existing configuration process by offering a shortcut. This shortcut allows you to configure the minimum number of parameters for these bridging protocols and routing protocols without having to exit and enter

the different configuration processes. The other parameters are set to selected defaults.

Situations that call for the router to be quickly configured are:

- Blank or corrupted configuration memory, such as when one of the following situations occurs:
  - The router is configured for the first time.
  - Voltage fluctuations resulted in corruption of configuration memory.
  - The CPU board, which contains the configuration memory chip, was replaced in the router.
- Demonstration purposes, for which the router needs to be quickly configured to demonstrate its capabilities.
- Bench-marking tests to get the tests going without having to learn the router's operating system commands.

Quick Config operates as follows:

- It asks a series of questions with default values.
- It offers a short-cut to the detailed configuration of the normal mode command set.

Quick Config sets a number of default parameters based upon how you answer the configuration questions.

What cannot be configured with Quick Config can be configured using Config after exiting it.

You cannot delete Quick Config information from within Quick Config. However, you can correct information either by exiting and returning to Quick Config, or by entering the **reload** command as a response to some Quick Config questions.

For complete information on using the Quick Config software, refer to the *Quick Configuration* information provided in the *IBM Nways Multiprotocol Switched Services (MSS) Server Module Planning and Setup Guide*.

## Manual Entry Into the Quick Config Mode

You might want to get to Quick Config manually to demonstrate the router's capabilities, reconfiguring on the fly to benchmark tests without having to learn the router's operating system commands.

To enter Quick Config, type **qconfig** at the Config> prompt.

## Exiting from Quick Config Mode

To exit Quick Config, restart by entering **r** from any prompt. Follow the queries until you enter **no** and then enter **q** to quit. The router returns to either the Config (only)> or the Config> prompt.



```

*****
Bridging Configuration
*****

Type 'Yes' to Configure Bridging
Type 'No' to skip Bridging Configuration
Type 'Quit' to exit Quick Config

Configure Bridging? (Yes, No, Quit): [Yes] y
Type 'r' any time at this level to restart Bridging Configuration

STB will be enabled on all LAN interfaces

Configure SRT Bridging? (Yes, No): [Yes] r

Restarting Bridging Configuration

Configure Bridging? (Yes, No): [Yes] n

*****
Protocol Configuration
*****

Type 'Yes' to Configure Protocols
Type 'No' to skip Protocol Configuration
Type 'Quit' to exit Quick Config

Configure Protocols? (Yes, No, Quit): [Yes] q

Quick Config Done

Config>

```

---

## Configuring User Access

The router configuration process allows for a maximum of 50 user names, passwords, and levels of permission. Each user added needs to be assigned a password and level of permission. There are three levels of permission: *Administration*, *Operation*, and *Monitoring*.

For more information, see the **add user** command on page 6-9.

## Technical Support Access

If you are the system administrator, when you add a new user for the first time, you are asked if you want to add Technical Support access. If you answer yes, Technical Support access is granted the same privileges as Administrator access.

The password for this account is automatically selected by the software and is known by your service representative. This password can be changed using the **change user** command; however, if you do change the password, customer service cannot provide remote support. For additional information on the use of the **change user** command, see page 6-12.

### Entering and Exiting CONFIG

To enter CONFIG from OPCON (\*):

1. At the OPCON prompt, enter the **status** command to find the PID of CONFIG. (See page 1-5 for a sample output of the **status** command.)

```
* status
```

2. Enter the OPCON **talk** command and the PID for CONFIG:

```
* talk 6
```

The console displays the CONFIG prompt (Config>). Now, you can enter CONFIG commands. If the prompt does not appear, press the **Return** key again. To exit CONFIG and return to the OPCON prompt (\*), enter the intercept character. (The default is **Ctrl P**.)

### Entering the Desired Protocol Configuration Process

For information on accessing a particular protocol's configuration process, see "Protocol" on page 6-20.

## CONFIG Commands

This section describes each of the CONFIG commands. Each command includes a description, syntax requirements, and an example. The CONFIG commands are summarized in Table 6-2.

After accessing the CONFIG environment, enter the configuration commands at the Config> prompt.

Table 6-2. CONFIG Command Summary

Command	Function
<b>? (Help)</b>	Lists the CONFIG commands or lists the options associated with specific commands.
<b>Add</b>	Adds an interface to the router configuration, or a user to the router.
<b>Boot</b>	Enters Boot CONFIG command mode.
<b>Change</b>	Changes a user's password or a user's parameter values associated with this interface. Also changes a slot/port of an interface.
<b>Clear</b>	Clears configuration information.
<b>Delete</b>	Deletes an interface from the router configuration or deletes a configured user.
<b>Disable</b>	Disables login from a remote console, system memory dumping and rebooting, or a specified interface.
<b>Enable</b>	Enables login from a remote console, enables modem use, enables system memory dumping and rebooting, or enables a specified interface.
<b>Write</b>	Writes the current configuration information to the non-volatile memory.

### ? (Help)

Use the ? (**help**) command to list the commands that are available from the current prompt level. You can also enter a ? after a specific command name to list its options.

**Syntax:** ?

**Example:** ?

```

ADD
BOOT
CHANGE
CLEAR
DELETE
DISABLE
ENABLE
EVENT
FEATURE
LIST
NETWORK
PATCH
PROTOCOL
QCONFIG
SET
TIME OF DAY PARAMS
UNPATCH
UPDATE
    
```

## CONFIG Commands

**Example:**            **list ?**  
                  devices  
                  configuration  
                  patches  
                  users  
                  v25-bis-address

## Add

Use the **add** command to add an interface to the configuration, or user-access. This command also recreates device records if the configuration is inadvertently lost.

**Syntax:** add                    device . . .  
  user . . .

*device device\_type additional-config-info*

With the **add device** command, you must enter the interface device type (*device\_type*). You are prompted for additional configuration parameters. This additional information varies by device and platform. Refer to "Accessing Network Interface Configuration and Console Processes" on page 1-16 for additional information about device type and configuration parameters.

**Note:** If you are adding more than one interface, the order in which you add them is important because the router assigns a sequential interface number to the device when it is added. This interface number is an index number in the device list; it links the device with other protocol configuration information, such as the IP addresses associated with the device. (For more information, refer to the **list devices** command on page 6-17.)

All device and protocol configuration information related to network interfaces is stored by interface number. Any changes made to interface numbers will invalidate much of the device configuration information in the protocols.

**Example:**            **add device atm**

```
Device Slot x(0-3) 0?  
Adding CHARM ATM Adapter device in slot 0 port 1 as interface x  
(where x is the interface number assigned)
```

To determine which devices you can add, use the **add devices ?** command.

When adding interfaces with more than one port, add one port at a time. Use the **add device** command twice to add both ports of a dual-port adapter, for example.

*user user\_name*

Gives a user access to the router. You can authorize up to 50 users to access the router. Each *user\_name* is eight characters and is case-sensitive.

When the first user is added, console login is automatically enabled. Each user added must be assigned one of the following permission levels.

Table 6-3 on page 6-9 describes the different access privileges that are available.

<i>Table 6-3. Access Privileges</i>	
<b>Level of Access</b>	<b>Description</b>
Administrator (A)	Displays configuration and user information, adds/modifies/deletes configuration and user information. The Administrator can access any router function.
Operator (O)	Views router configuration, views statistics, runs potentially disruptive tests, dynamically changes router operation, and restarts the router. Operators cannot modify the permanent router configuration. All actions can be undone with a system restart.
Monitor (M)	Views router configuration and statistics but cannot modify or disrupt the operation of the router.
Tech Support	Allows your service representative to gain access to the router if a password is forgotten. Cannot be assigned to users.

**Note:** To add a user, you must have administrative permission. You do not have to reinitialize the router after adding a user.

**Example:**            **add user John**  
 Enter password:  
 Enter password again:  
 Enter permission (A)dmin, (O)perations, (M)onitor [A]?  
 Do you want to add Technical Support access?  
 (Yes or [No]):

*Enter password*                                Specifies the access password for the user. Limited to 80 alphanumeric characters and is case-sensitive.

*Enter password again*                        Confirms the access password for the user.

*Enter permission*                              Specifies the access permission for the user: A, O, or M. (See Table 6-3.)

## Boot

Use the **boot** command to enter the Boot CONFIG command environment. For Boot CONFIG information, see Chapter 7, “The Boot/Dump Configuration Process and Commands” on page 7-1.

**Syntax:** `boot`

**Example:**            **boot**  
 TFTP Boot/dump configuration  
 Boot config>

## Change

Use the **change** command to modify an interface in the configuration, change your own password, or change user information.

## CONFIG Commands

**Syntax:** change                    device . . .  
   password  
   user

**Example:**                            **change device**  
   Which configured slot would you like to change? (1, 2) [1]? 2  
   Which slot would you like to change to? (1-2) [1]? 1  
   Changed slot 2 to slot 1 in 1 intf (port) record...

`device device_type`

With the **change device** command you can:

- Change the slot of an existing interface. (Change slot x in interface record n to y where slot y is unoccupied.)
- Swap slots of two existing interfaces. (Swap slot x and slot y in interface records with x or y.)
- Replace the slot in an existing interface with the slot in another. (Interface configuration for slot x will become interface configuration for slot y. Interface records for slot y will be deleted.)

When the target slot is occupied:

1. If the "swap" option is selected, the source and target slots are swapped in the interface records in which they appear.
2. If the "replace" option is selected, the interface configuration for slot x will become the interface configuration for slot y. Interface records for slot y will be deleted.

**Example:** Change slot 2 on interface 0 to unoccupied slot 1.

```

Config>list dev
Ifc 0 CHARM ATM                               Slot: 2 Port: 1

Config>change device
Which configured slot would you like to change? (2) [2]? 2
Which slot would you like to change to? (1-2) [1]? 1

Changed slot 2 to slot 1 in 1 intf (port) record...

Config>list dev
Ifc 0 CHARM ATM                               Slot: 1 Port: 1

Example: Change (swap) slot 2 on interface 1 to occupied slot 1.
Config>list dev
Ifc 0 CHARM ATM                               Slot: 1 Port: 1
Ifc 1 CHARM ATM                               Slot: 2 Port: 1

Config>change device
Which configured slot would you like to change? (1, 2) [2]? 2
Which slot would you like to change to? (1-2) [1]? 1

Configuration for slot 1 already exists. You can:
a - abort this operation
r - replace configuration
   (Interface configuration for slot 2 will become interface
   configuration for slot 1. Interface records for slot 1
   will be deleted!)
s - swap configuration (slot 1 will be swapped with slot 2.)
s

Swapped slot 2 with slot 1 in 1 port record...

Config>list dev
Ifc 0 CHARM ATM                               Slot: 2 Port: 1
Ifc 1 CHARM ATM                               Slot: 1 Port: 1

Example: Change (replace) slot 1 on interface 1 to occupied slot 2.
Config>list dev
Ifc 0 CHARM ATM                               Slot: 2 Port: 1
Ifc 1 CHARM ATM                               Slot: 1 Port: 1

Config>change device
Which configured slot would you like to change? (1, 2) [2]? 1
Which slot would you like to change to? (1-2) [1]? 2

Configuration for slot 2 already exists. You can:
a - abort this operation
r - replace configuration
   (Interface configuration for slot 1 will become interface
   configuration for slot 2. Interface records for slot 2
   will be deleted!)
s - swap configuration (slot 1 will be swapped with slot 2.)
r

Moved slot 2 to slot 1 in 1 intf (port) record...

Config>list dev
Ifc 0 CHARM ATM                               Slot: 2 Port: 1

```

password

Modifies the password of the user who is now logged in.

**Note:** To change a user password, you must have administrative permission.

**Example:**            **change password**

```

Enter current password:
Enter new password:
Enter new password again:

```

## CONFIG Commands

<i>Enter current password</i>	Specifies your current password.
<i>Enter new password</i>	Specifies your new password.
<i>Enter new password again</i>	Specifies your new password again for confirmation. If your confirmation does not match the previous new password, the old password remains in effect.

### user

Modifies the user information that was previously configured with the **add user** command.

**Note:** To change a user, you must have administrative permission.

**Example:**

```
change user
User name: []
Change password? (Yes or No)
Change permission? (Yes or [No])
```

## Clear

Use the **clear** command to delete the router's configuration information from non-volatile configuration memory.

**Attention:** Use this command only after calling your service representative.

To clear a process from non-volatile configuration memory, enter the **clear** command and the process name. To clear all information from configuration memory, except for device information, use the **clear all** command. If you want to clear all information, including the device information, use the **clear all** command and then the **clear device** command.

The **clear user** command clears all user information except the router console login information. This is left as enabled (if it was configured as enabled) even though the default value is "disabled."

### Notes:

1. To clear user information, you must have administrative permission.
2. There may be other items in the list, depending upon what is included in the software load.



**Syntax:** clear                    all  
arp (ARP)  
asrt (Adaptive Source Route Protocol)  
bgp (Border Gateway Protocol)  
boot  
device  
els (Event Logging System Information)  
ip (IP)  
ipx (Novell IPX)  
ospf (OSPF routing protocol)  
snmp  
srb (Source Route Bridge)  
stb (Spanning Tree Bridge)  
tcp/ip-host  
time (Time of day information)  
user

**Example:**                    **clear ELS**  
You are about to clear all Event Logging configuration information  
Are you sure you want to do this (Yes or No):

**Note:** The previous message appears for any parameter configuration you are deleting.

## Delete

Use the **delete** command to remove an interface from the list of devices stored in the configuration, or to remove a user. To use the **delete** command, you must have administrative permission.

**Syntax:** delete                    interface . . .  
user . . .

interface *intfc#*

To delete an interface, enter the interface or network number as part of the command. (Dial circuit is the only device type that can be deleted.) To obtain the interface number that the router assigns, use the **list device** command.

The delete interface command deletes the device configuration and any protocol information for that interface. However, the router will continue to run the previous configuration until it is reloaded.

When deleting a base ISDN interface or a base ATM interface all virtual interfaces running on that base net will also be deleted. So, any dial circuits configured on a base ISDN interface will be removed when the ISDN interface is deleted. Also, when deleting an ATM base net, all Lan Emulation Clients running on the base ATM interface will be deleted.

**Example:**                    **delete interface 2**  
Interface 2 was deleted successfully

user *user\_name*

Removes user access to the router for the specified user.

**Example:**                    **delete user mary**  
Are you sure you want to delete user 'mary'?(Y / N)\_

### Disable

Use the **disable** command to prevent being prompted for a login from a remote console . The **disable** command also disables a specified interface. If the router has two service ports specify either **service1** or **service2**.

**Syntax:** disable                    console-login  
  interface . . .  
  dump-memory . . .  
  reboot-system . . .

console-login

Disables the user from being prompted for a user ID and password on the physical console. The default is disabled.

**Example:**                    **disable console-login**

interface *interface*#

Causes the specified interface to be disabled after issuing the **reload** command. The default is enabled.

**Example:**                    **disable interface 2**

dump-memory

Disables the dumping of system memory to the installed hard disk when a serious error occurs.

**Example:**                    **Config> disable dump**  
  Disable system memory dumping? ([No]) Yes

System memory dump function disabled successfully.

reboot-system

Disables the rebooting of the system when a serious error occurs. This may be desirable if the network service personnel wish to troubleshoot the error on-line. System rebooting cannot be disabled unless memory dumping is also disabled. If you attempt to disable system rebooting while memory dumping is enabled, system rebooting is aborted and the following message is displayed:

System reboot not disabled: memory dumping must be disabled first

**Example:**                    **Config> disable reboot**  
  Disable system reboot for serious errors? ([No]) Yes

System reboot function disabled successfully.

### Enable

Use the **enable** command to allow login from a remote console, and enable a specified interface.

**Syntax:** enable                    console-login  
  interface . . .  
  dump-memory . . .  
  reboot-system . . .

console-login

Enables the user to be prompted for a user ID and password on the physical console. This is useful for security situations. If you do not configure any administrative users and you enable this feature, the following message appears:

```
Warning: Console login is disabled until an
administrative user is added.
```

By disabling the console login, a lock-out situation is prevented.

**Example:**            **enable console-login**

interface *interface#*

Causes the interface to be enabled after issuing the **reload** command.

dump-memory

Enables the dumping of system memory to the installed hard disk when a serious error occurs. This may be desirable so that the state of the unit at the time of the error can be preserved for troubleshooting later. The dump memory function cannot be enabled unless system rebooting is enabled. If you attempt to enable the dump memory function while system rebooting is disabled, dump memory is aborted and the following message is displayed:

```
System memory dump function not enabled: rebooting must be enabled first
```

**Example:**            **Config> enable dump**  
 Enable system memory dumping? ([No]) Yes  
  
 System memory dump function enabled successfully.

reboot-system

Enables the rebooting of the system when a serious error occurs.

**Example:**            **enable reboot-system**  
 Enable system rebooting for serious errors? ([No]) Yes  
  
 System reboot function enabled successfully.

## Event

Use the **event** command to enter the Event Logging System (ELS) environment so that you can define the messages that will appear on the console. Refer to Chapter 11, “Using and Configuring the Event Logging System (ELS)” for information about ELS.

**Syntax:** event

**Example:**            **event**  
 Event Logging System user configuration  
 ELS config>

## Feature

Use the **feature** command to access configuration commands for specific router features outside of the protocol and network interface configuration processes.

## CONFIG Commands

All IBM 8210 features have commands that are executed by:

- Accessing the configuration process to initially configure and enable the feature, as well as perform later configuration changes.
- Accessing the console process to monitor information about each feature, or make temporary configuration changes.

The procedure for accessing these processes is the same for all features. The following information describes the procedure.

Enter a question mark after the **feature** command to obtain a listing of the features available for your software release.

```
Example:      feature ?
              MCF
              QOS
              Feature name or number [2] ?
```

To access a feature's configuration prompt, enter the **feature** command followed by the feature number or short name. Table 6-4 lists available feature numbers and names.

Feature Number	Feature Short Name	Accesses the following feature configuration process
2	MCF	MAC Filtering
6	QOS	Quality of Service

```
Example:      feature mcf
              MAC filtering user configuration
              Filter Config>
```

Once you access the configuration prompt for a feature, you can begin entering specific configuration commands for the feature. To return to the CONFIG prompt, enter the **exit** command at the feature's configuration prompt.

**Syntax:** `feature feature# OR feature-short-name`

```
Example:      feature 2
              or
              feature MCF
```

## System Memory Dump

Use the **system memory dump** command to retrieve the memory image file from the installed hard disk after a serious error has occurred.

**Syntax:** `system retrieve`

**retrieve** Uses TFTP to send the memory image to a remote location, with a destination TFTP file address, path, and file name supplied by the user.

If memory dumping is disabled, the function is aborted and the following message is displayed:

```
Image file transfer aborted: function disabled
```

If the memory file is not present on the hard disk, or if the hard disk has been removed, the function is aborted and the following message is displayed.

Image file transfer aborted: image file not found

**Example:**            **system retrieve**  
 Destination IP address (0.0.0.0) **2.2.2.2**  
 Fully qualified destination path/file name (tmp/dump.dat)  
 The memory image file is nnnnn bytes long.  
 Proceed? (Y/[N])

## List

Use the **list** command to display configuration information for all network interfaces, or configuration information for the router.

**Syntax:** `list`                    devices  
     configuration  
     patches  
     vpd

### devices

Displays the relationship between an interface number and the hardware interface. You can also use this command to check that a device was added correctly issuing the **add** command.

**Example:**

**list devices**

Ifc 0 CHARM ATM Adapter        Slot: 1    Port: 1

### configuration

Displays configuration information about the router.

**Example:**

**list configuration**

## CONFIG Commands

```
Hostname: acctg
Maximum packet size: [autoconfigured]
Maximum number of global buffers: [autoconfigured]
Console baudrate: 9600 (Autobaud)
Console inactivity timer (minutes): 0
Physical console login: disabled
Modem Control Enabled, using CARRIER-WAIT type control
Contact person for this node: [none]
Location of this node: [none]
```

### Configurable Protocols:

```
Num Name Protocol
0 IP DOD-IP
3 ARP Address Resolution
7 IPX NetWare IPX
11 SNMP Simple Network Management Protocol
10 BGP Border Gateway Protocol
12 OSPF Open SPF-Based Routing Protocol
23 ASRT Adaptive Source Routing Transparent Enhanced Bridge
24 HST TCP/IP Host Services
```

### Configurable Features:

```
Num Name Feature
2 MCF MAC Filtering
6 QOS Quality of Service
```

27616 bytes of configuration memory free

### patches

Displays the values of patch variables that have been entered using the **patch** command.

#### Example:

#### **list patches**

Patched variable	Value
ping-size	60
ping-ttl	59
ip-default-ttl	60
ethernet-security	3
rip-static-suppress	3

### vpd

Displays the hardware and software vital product data.

## Network

Use the **network** command to enter the network interface configuration environment for supported networks. Enter the interface or network number as part of the command. (To obtain the interface number, use the CONFIG **list device** command.) The appropriate configuration prompt (for example, TKR Config>) will be displayed. See the network interface configuration chapters in this book for complete information on configuring your types of network interfaces.

**Note:** Whenever you change a user-configurable parameter, you must **reload** the router for the change to take effect. To do so, enter the **reload** command at the OPCODE prompt (\*).

**Syntax:** network *interface#*

#### Example:

```
network 0
TKR config>
```

**Note:** Not all network interfaces are user-configurable. For interfaces that you cannot configure, you receive the message: That network is not configurable.

## Patch

Use the **patch** command for modifying the router's global configuration. Patch variables are recorded in nonvolatile configuration memory and take effect immediately; you do not have to wait for the next restart of the router. This command should be used only for handling uncommon configurations. Anything that you commonly configure should still be handled by using the specific configuration commands. The following is a list of the current patch variables documented and supported for this release.

**Syntax:** patch                   bgp-subnets  
                                  ethernet-security  
                                  ip-default-ttl  
                                  ip-mtu  
                                  more-lines  
                                  mosheap-lowmark  
                                  ospf-import-rate  
                                  ping-size  
                                  ping-ttl  
                                  relax-jate  
                                  rip-static-suppress

**Example:**                   **patch ping-size**  
                                  New value [0]?

### *bgp-subnets new value*

If you want the BGP speaker to advertise subnet routes to its neighbors, set *new value* to 1. The default is 0.

*New value*                   The new value for the variable that you are patching.

### *ethernet-security*

When set to a non-zero value, zeros the padding that is applied to Ethernet packets whose data portion is less than the physical minimum of 60 bytes. This may be required for security reasons. Default: 0.

### *ip-default-ttl*

The TTL used in packets that are originated by the router. The default is 64.

**Note:** It is preferable to set this parameter with the **set ttl** IP configuration command. (See the "Set" section of the "Using and Configuring IP" chapter of *Multiprotocol Switched Services (MSS) Server Command Line Interface Volume 1*.) This patch variable remains for compatibility with configurations from older releases.

### *ip-mtu*

This parameter limits the IP MTU size to the specified value. When this parameter is set, the IP MTU size on a given network interface is set to the lesser of the ip-mtu value and the largest value that network interface's configured frame size can accommodate.

### *more-lines*

The number of lines to display on the console when listing the IP routing table, which uses a "more pipe" (!).

## CONFIG Commands

### *mosheap-lowmark*

This parameter specifies the percentage of free MOS heap memory, at which the device notifies the operator that an out-of-memory error is imminent. This notification allows the operator to take action to free up MOS heap memory before the device receives an error and stops.

When the operator receives notification, the operator can reconfigure the router and then reboot, minimizing the outage to the network. Specifying 0 for this parameter suppresses this warning.

**Valid Values:** 0 to 100

**Default Value:** 10

### *ospf-import-rate*

Number of routes imported per second.

### *ping-size*

The size of the data portion (that is, excluding IP and ICMP headers) of the ICMP ping packet that is sent via the IP>**ping** command. Default: 56 bytes. (The size of the ping data can also be entered as a parameter of the **ping** command as described in the “Ping” section of the “Monitoring IP” chapter of *Multiprotocol Switched Services (MSS) Server Command Line Interface Volume 1*.)

### *ping-ttl*

The TTL (time-to-live) sent in pings by the IP>**ping** command. Default: 64. (The TTL can also be entered as a parameter of the **ping** command as described in the “Ping” section of the “Monitoring IP” chapter of *Multiprotocol Switched Services (MSS) Server Command Line Interface Volume 1*.)

### *relax-jate*

Relaxes JATE ISDN restriction.

### *rip-static-suppress*

When set to a non-zero value, static routes will not be advertised by RIP over a given interface unless the IP config> **enable send static** command is given for the interface. This changes the semantics of the **enable send static** command. When rip-static-suppress is equal to 0 (the default), the list of the routes advertised via RIP is the union of those specified by the interface’s RIP flags.

**Note:** You must specify the complete name of the patch variable that you want to change. You cannot use an abbreviated syntax for the patch name.

## Protocol

Use the **protocol** command at the Config> prompt to enter the configuration environment for the protocol software installed in the router. The **protocol** command followed by the desired protocol number *or* short name lets you enter a protocol’s command environment. After you enter this command, the prompt of the specified protocol appears. From the prompt, you can enter commands specific to that protocol. Table 1-2 on page 1-15 lists examples of protocol numbers and names. To return to Config>, enter the **exit** command.



**Notes:**

1. To see the names and numbers of the protocols in your software load, at the Config> prompt, enter **list configuration**.
2. When you change a user-configurable parameter, you must restart the router for the change to take effect. To do so, enter the **reload** command at the OPCON prompt (\*).

The changes you make through CONFIG are kept in a configuration database in non-volatile memory and are recalled when you restart the router.

**Syntax:** protocol *prot#*

**Example:**            **protocol 7**  
                           *or*  
                           **protocol ipx**  
  
                           IPX config>

## Qconfig

Use the **qconfig** command to initiate Quick Config. Quick Config allows you to configure parameters for bridging protocols, and routing protocols without entering separate configuration environments.

**Syntax:** qconfig

**Note:** For complete information on using the Quick Config software provided with your router, refer to the *IBM Nways Multiprotocol Switched Services (MSS) Server Module Planning and Setup Guide*.

## Set

Use the **set** command to configure various system-wide parameters.

**Syntax:** set                                    contact-person . . .  
   down-notify . . .  
   global-buffers  
   hostname  
   inactivity-timer  
   input-low-water  
   location . . .  
   packet-size  
   prompt-level  
   receive-buffers

contact-person *sysContact*

Sets the name or identification of the contact person for this managed SNMP node. There is a limit of 80 characters for the *sysContact* name length.

This variable is for information purposes only and has no effect on router operation. It is useful for SNMP management identification of the system.

**Example:**            **set contact-person nautilus**

Select the data link type for a serial interface.

## CONFIG Commands

`down-notify interface# # of seconds`

Allows the user to specify the number of seconds before declaring an interface as being down. The normal maintenance packet interval is 3 seconds, and it takes four maintenance failures to declare the interface as down.

The **set down-notify** command is used primarily when tunneling LLC traffic over an IP network using OSPF. If an interface goes down, OSPF cannot detect it fast enough because of the length of time that it takes for an interface to be declared down. Therefore, LLC sessions would begin to timeout. You can set the down-notify timer to a lower value, allowing OSPF to sense that an interface is down quicker. This enables an alternate route to be chosen more quickly, which will prevent the LLC sessions from timing out.

**Note:** If the **set down-notify** command is executed on one end of a serial link, the same command must be performed at the other end of the link or the link may not come up and stay up.

*Interface#*

The number of the interface you are configuring.

*# of seconds*

The down notification time value that specifies the maximum time that will elapse before a down interface is marked as such. Large values will cause the router to ignore transient connection problems, and smaller values will cause the router to react more quickly. The range of values is 1 to 300 seconds and the default is 0, which sets the 3-second period. Setting the down notification time to 0 will restore the default time for that interface.

The **list devices** command will show the down notification time setting for any interface that has the default value overridden.

**Example:**            `set down-notify 4 3`

`global-buffers max#`

Sets the maximum number of global packet buffers, which are the packet buffers used for locally originated packets. The default is to autoconfigure for the maximum number of buffers (up to 1000). To restore the default, set the value to 0. To display the setting for global-buffers, use the **list configuration** command.

**Example:**            `set global-buffers 30`

`hostname`

Adds or changes the router name. The router name is for identification only; it does not affect any router addresses. The name must be:

- Less than 78 characters and is case sensitive

**Example:**            `set hostname sales`

`inactivity-timer # of min`

Changes the setting of the Inactivity Timer. The Inactivity Timer logs out a user if the remote or physical console is inactive for the period of time specified in this command. This command affect only consoles that require login. The default setting of 0 turns the inactivity timer off, indicating that no logoff is performed, no matter how long a console remains inactive.

**Example:**            `set inactivity-timer 3`

`input-low-water interface # low # of receive buffers`

Allows you to configure the value of the low number of receive buffers, or packets, on a per-interface basis, thus overriding the default values.

The memory allocation strategy changes to conserve buffers when the number of free buffers is equal or less than the low or low-water mark value. When a packet is received, and the current value of the interface is less than the low water value, then that packet is eligible for flow control (dropping).

The range of values is 1 to 255. The default is both platform and device specific. Setting the value to 0 restores the autoconfigured default.

*Interface #* is the number of the interface you are configuring. *Low # of receive buffers* is the low water value.

Lowering the value will make it less likely that packets from this interface will be dropped when sent on congested networks. However, lowering the value may negatively affect performance if it drops packets to the extent that the receive queue is frequently empty. Raising the value has the opposite effect.

Type the **QUEUE** or **BUFFER** command at the GWCON prompt (+) to show the low setting.

**Example:**            `set input-low-water 4 7`

`location sysLocation`

Sets the physical location of an SNMP node. There is a limit of 80 characters for the *sysLocation* name length. This variable is for information purposes only and has no effect on router operation. It is useful for SNMP management identification of the system.

**Example:**            `set location atlanta`

`packet-size max packet size in bytes`

Establishes or changes the maximum size of a packet buffer.

**Attention:** Use this command only under direct instructions from your service representative. **Never** use it to reduce packet size – **only** to increase it.

**Example:**            `set packet-size`

`prompt-level user-defined-name`

Adds a user-defined name as a prefix to all operator prompts, replacing the hostname.

The user-defined-name can be any combination of characters, numbers, and spaces up to 80 characters. Special characters may be used to request additional functions as described in Table 6-5 on page 6-24.

**Example:**            `set prompt`  
                           What is the new MOS prompt [y]? **AnyHost 99**  
                           AnyHost 99 Config>

Table 6-5. Additional Functions Provided by the Set Prompt Level Command

Special Characters	Function Provided by the Set Prompt Level Command
\$n	Displays the hostname. This is useful when you want the hostname included in the prompt. For example:  Config> <b>set prompt</b> What is the new MOS prompt [y]? \$n hostname:: Config>
\$t	Displays the time. For example:  Config> <b>set prompt.</b> What is the new MOS prompt [y]? \$t 02:51:08[GMT-300] Config>
\$d	Displays the current date-month-year. For example:  Config> <b>set prompt.</b> What is the new MOS prompt [y]? \$d 26-Feb-1997 Config>
\$v	Displays the software VPD information in the following format: program-product-number Feature xxxx Vx Rx.x PTFx RPQx
\$e	Erases one character <i>after</i> this combination within the user-defined prompt.
\$h	Erases one character <i>before</i> this combination within the user-defined prompt.
\$_	Adds a carriage return to the user-defined prompt.
\$\$	Displays the \$.

**Note:** You can combine these commands. For example:

```
Config> set prompt.
What is the new MOS prompt [y]? $n:$d
hostname::26-Feb-1997 Config>
```

`receive-buffers interface # max #`

Adjusts the number of private receive buffers for most interfaces. The range is 5 to 255.

**Note:** This command is not applicable for ISDN Primary Rate Interfaces. For ISDN PRI, the interface handler determines the value based on the number of dial circuits configured.

To restore the default, set the value to 0. The **set receive-buffers** command can be used to increase the receive performance of an interface. In addition, this command can be used to reduce flow control drops when the router is forwarding many packets from a fast interface to a slow interface. The effect of this command is visible on the **GWCON buffer** command.

**Attention:** Use this command only under direct instructions from your service representative.

**Example:** `set receive-buffers 4 30`

## Time

Use the **time** command to set the IBM 8210 system clock and date, and to display the values on the user console. These values can then be used to time-stamp ELS messages.

**Note:** The IBM 8210 has a hardware clock that maintains the date and time after router re-initialization.

**Syntax:** `time`                    `host . . .`  
    `list`  
    `offset`  
    `set . . .`  
    `sync . . .`

`host` *IP\_address*

Sets the IP address of the RFC 868-compliant host which will be used as the time source. This is the address of a host which will respond to an empty datagram on UDP port 37 with a datagram containing the current time.

**Example:**                    `time host 131.210.1.4`

`list`

Displays all configured time-related parameters. This includes the current time (if set) and the source of the time (operator or IP address from which time was last received).

**Example:**                    `time list`

```
05:20:27 Wednesday December 7, 1994
Set by: operator
Time Host: 131.210.4.1                    Sync Interval: 10
seconds
GMT Offset: -300 minutes
```

`offset` *minutes*

Defines the time zone, in minutes, offset from GMT (Greenwich Mean Time). Note that values west of GMT are negative. For example, EST is 5 hours earlier than GMT, so the command would be **time offset -300**.

**Example:**                    `time offset`

```
minutes from GMT (-720 to 720) [0]? -300
```

`set` *<year month date hour minute second>*

Prompts you to set the current time. If you do not specify the entire time in the command, you are prompted for the remaining values. You can change the date as shown in the following example.

**Example:**                    `time set`

```
year [1996] 1997
month [12]?
date [6]? 7
hour [11]? 12
minute [3]?
second [2]?
```

`sync` *seconds*

Sets the period, in seconds, at which the router will poll the time host for the current time.

**Example:**            `time sync 300`

## Unpatch

Use the **unpatch** command to restore the values of the patch variables entered with the **patch** command to their default values. See the **patch** command in “Patch” on page 6-19.

**Note:** You *must* specify the long name of the patch variable to be restored.

**Syntax:** `unpatch variable name`

**Example:** `unpatch ethernet-security`

## Update

Use the **update** command to update the configuration memory when you receive a new software load. Follow the instructions on the release notice sent with the software. The **update** command is the last command that you enter when loading new software. After you enter this command, the console displays a message indicating configuration memory is being updated.

**Syntax:** `update version-of-SRAM`

**Example:** `update version-of-SRAM`

Updating configuration memory to V15.2 [X104]

---

## Chapter 7. The Boot/Dump Configuration Process and Commands

This chapter describes the Boot/Dump Configuration process. This chapter includes the following sections:

- “Understanding Change Management”
- “Using the Trivial File Transfer Protocol (TFTP)”
- “Entering and Exiting Change Management Configuration Environment” on page 7-2
- “Change Management Configuration Commands” on page 7-2

---

### Understanding Change Management

Change management refers to the handling of software and configuration data for a 8210. This involves:

1. Moving code and configuration data to and from the 8210
2. Moving code and configuration data on the 8210 persistent storage device, which is currently a disk drive and flash memory
3. Selecting and Activating specific combinations of software and configuration.

The change management functions are available through the `Boot config>` environment (available through talk 6), or the firmware should the box be in a condition where the hard drive does not contain viable software (that is, you cannot access talk 6). During normal operations, access the change management functions through the `Boot config>` prompt.

The 8210 code and configuration data storage resource is divided into areas called “system banks” (banks for short), each containing a single version of the operational code and any other ancillary files pertinent to that release of the code. Up to four configuration files are associated with each bank’s software.

The general change management model of the 8210 is to introduce new code and or configuration data to the system while the system runs at its present level and then activate the changed code or configuration data set later. If for some reason the new code or configuration does not function as expected, you have the ability to revert to the previous version of the configuration.

---

### Using the Trivial File Transfer Protocol (TFTP)

TFTP is a file transfer protocol that runs over the Internet UDP protocol. This implementation provides multiple, simultaneous TFTP file transfers between a 8210’s non-volatile configuration memory, image bank, and remote hosts.

TFTP allows you to:

- Get a configuration file from a server to a 8210
- Put a configuration file from a 8210 to a server

## Change Management Commands

TFTP transfers involve a *client* node and a *server* node. The client node generates a TFTP Get or Put request onto the network. The 8210 acts as a client node by generating TFTP requests from the 8210 console using the `Boot config> process tftp` command.

The client can transfer a copy of a configuration file or image file stored in an image bank of a server.

The server is any device (for example, a personal computer or workstation) that receives and services the TFTP requests. Use the ELS subsystem TFTP message log to view the transfer in progress.

---

## Entering and Exiting Change Management Configuration Environment

To enter the change management configuration command environment, use the CONFIG **boot** command. When the router's software is initially loaded, it is running in the OPCON process, signified by the \* prompt. From the \* prompt:

1. Enter **talk 6**.
2. At the `Config>` prompt, type **boot**.
3. At the `Boot config>` prompt, type **?**. The following appears:

```
ADD description
COPY software
DESCRIBE software
ERASE software
LIST software
LOCK Config file
SET boot information
TFTP software
UNLOCK Config file
EXIT
```

To return to the CONFIG process, type **exit**.

---

## Change Management Configuration Commands

This section describes the Change Management Configuration commands. Each command includes a description, syntax requirements, and an example. Table 7-1 on page 7-3 summarizes the Change Management Configuration commands.

After accessing the Change Management Configuration environment, enter the configuration commands at the `Boot config>` prompt.



<i>Table 7-1. Change Management Configuration Commands</i>	
<b>Command</b>	<b>Function</b>
<b>? (Help)</b>	Displays a list of the commands available from that prompt level.
<b>Add</b>	Adds an optional description to a configuration file.
<b>Copy</b>	Copies boot files and configuration files to or from banks.
<b>Describe</b>	Displays information about the stored loadfile images.
<b>Erase</b>	Erases a stored image or a configuration file.
<b>List</b>	Displays information about load images and configuration files.
<b>Lock</b>	Prevents the device from overwriting the selected configuration with any other configuration.
<b>Set</b>	Selects code bank and configuration to be used.
<b>TFTP</b>	Initiates TFTP file transfers between 8210 remote servers.
<b>Unlock</b>	Removes the lock from a configuration allowing the configuration to be updated by the device.
<b>Exit</b>	Leaves the Change Management Configuration environment and returns to the CONFIG process.

**? (Help)**

Use the ? (**help**) command to list the commands that are available from the current prompt level. You can also enter a ? after a specific command name to list its options.

**Syntax:** ?

**Example:** Boot config>?

```

ADD description
COPY software
DESCRIBE software VPD
ERASE software
LIST software status
LOCK Config File
SET boot information
TFTP software
UNLOCK Config File
EXIT

```

## Change Management Commands

### Add

Use the **add** command to add an optional description to a configuration file.

**Syntax:** *add* configuration file load image description

**Example:** Boot config> **add**

```
+----- BankA -----+----- Description -----+----- Date -----+
| IMAGE - NONE                |                               | 01 Jan 1970 00:01 |
| CONFIG 1 - AVAIL            | test config for pubs         | 01 Jan 1970 01:26 |
| CONFIG 2 - AVAIL *          | test config for pubs         | 01 Jan 1970 01:13 |
| CONFIG 3 - AVAIL            |                               | 01 Jan 1970 01:39 |
| CONFIG 4 - AVAIL            |                               | 01 Jan 1970 01:52 |
+----- BankB -----+----- Description -----+----- Date -----+
| IMAGE - ACTIVE              |                               | 01 Jan 1970 00:30 |
| CONFIG 1 - AVAIL            | test config for pubs         | 01 Jan 1970 00:54 |
| CONFIG 2 - AVAIL            |                               | 01 Jan 1970 00:01 |
| CONFIG 3 - AVAIL            |                               | 01 Jan 1970 00:14 |
| CONFIG 4 - ACTIVE *         |                               | 01 Jan 1970 00:24 |
+----- BankF -----+----- Description -----+----- Date -----+
| IMAGE - AVAIL                |                               | 01 Jan 1970 00:30 |
| CONFIG 1 - AVAIL            | test config for pubs         | 01 Jan 1970 00:54 |
| CONFIG 2 - AVAIL            |                               | 01 Jan 1970 00:01 |
| CONFIG 3 - AVAIL            |                               | 01 Jan 1970 00:14 |
| CONFIG 4 - AVAIL            |                               | 01 Jan 1970 00:24 |
+-----+-----+-----+
* - Last Used Config      L - Config File is Locked
```

Select the source bank: (A, B, F): [A]

Select the source configuration: (1, 2, 3, 4): [1] 3

Enter the description of the file: () **New config for today**

Attempting to set description for bank A configuration 3.

Operation completed successfully.

Boot config>**list**

```
+----- BankA -----+----- Description -----+----- Date -----+
| IMAGE - NONE                |                               | 01 Jan 1970       |
| CONFIG 1 - AVAIL            | test config for pubs         | 01 Jan 1970 00:58 |
| CONFIG 2 - AVAIL *          | test config for pubs         | 01 Jan 1970 01:13 |
| CONFIG 3 - NONE             | New config for today         | 09 Jan 1970 00:58 |
| CONFIG 4 - AVAIL            |                               | 01 Jan 1970 01:05 |
+----- BankB -----+----- Description -----+----- Date -----+
| IMAGE - ACTIVE              |                               | 01 Jan 1970       |
| CONFIG 1 - AVAIL            | test config for pubs         | 01 Jan 1970 00:54 |
| CONFIG 2 - AVAIL            |                               | 01 Jan 1970 00:01 |
| CONFIG 3 - AVAIL            |                               | 01 Jan 1970 00:14 |
| CONFIG 4 - ACTIVE *         |                               | 01 Jan 1970 00:24 |
+----- BankF -----+----- Description -----+----- Date -----+
| IMAGE - AVAIL                |                               | 01 Jan 1970       |
| CONFIG 1 - AVAIL            | test config for pubs         | 01 Jan 1970 00:54 |
| CONFIG 2 - AVAIL            |                               | 01 Jan 1970 00:01 |
| CONFIG 3 - AVAIL            |                               | 01 Jan 1970 00:14 |
| CONFIG 4 - AVAIL            |                               | 01 Jan 1970 00:24 |
+-----+-----+-----+
* - Last Used Config      L - Config File is Locked
```

# COPY

Use the **copy** command to copy configuration files and image files to and from image banks.

**Syntax:** `copy configuration [file]`  
`load [image]`

**Example:** Boot config>`copy load`

BankA	Description	Date
IMAGE - AVAIL		01 Jan 1970 00:01
CONFIG 1 - AVAIL	test config for pubs	01 Jan 1970 01:26
CONFIG 2 - AVAIL *	test config for pubs	01 Jan 1970 01:13
CONFIG 3 - AVAIL		01 Jan 1970 01:39
CONFIG 4 - AVAIL		01 Jan 1970 01:52
BankB	Description	Date
IMAGE - ACTIVE		01 Jan 1970 00:01
CONFIG 1 - AVAIL		01 Jan 1970 00:14
CONFIG 2 - AVAIL		01 Jan 1970 00:01
CONFIG 3 - AVAIL		01 Jan 1970 00:37
CONFIG 4 - ACTIVE *		01 Jan 1970 00:24
BankF	Description	Date
IMAGE - AVAIL		01 Jan 1970 00:01
CONFIG 1 - AVAIL		01 Jan 1970 00:14
CONFIG 2 - AVAIL		01 Jan 1970 00:01
CONFIG 3 - AVAIL		01 Jan 1970 00:37
CONFIG 4 - ACTIVE *		01 Jan 1970 00:24

\* - Last Used Config      L - Config File is Locked

Select the source bank: (A, B, F): [A] b  
Select the destination bank: (A, B): [B] a  
Copy SW load image from: bank B  
  to: bank A.

Operation completed successfully.

**Example:** Boot config>`copy configuration`

## Change Management Commands

BankA	Description	Date
IMAGE - CORRUPT		01 Jan 1970 00:01
CONFIG 1 - AVAIL	test config for pubs	01 Jan 1970 01:26
CONFIG 2 - AVAIL *	test config for pubs	01 Jan 1970 01:13
CONFIG 3 - AVAIL		01 Jan 1970 01:39
CONFIG 4 - AVAIL		01 Jan 1970 01:52
BankB	Description	Date
IMAGE - ACTIVE		01 Jan 1970 00:01
CONFIG 1 - AVAIL		01 Jan 1970 00:14
CONFIG 2 - AVAIL		01 Jan 1970 00:01
CONFIG 3 - AVAIL		01 Jan 1970 00:37
CONFIG 4 - ACTIVE *		01 Jan 1970 00:24
BankF	Description	Date
IMAGE - AVAIL		01 Jan 1970 00:01
CONFIG 1 - AVAIL		01 Jan 1970 00:14
CONFIG 2 - AVAIL		01 Jan 1970 00:01
CONFIG 3 - AVAIL		01 Jan 1970 00:37
CONFIG 4 - AVAIL		01 Jan 1970 00:24

\* - Last Used Config      L - Config File is Locked

```
Select the source bank: (A, B, F): [A]
Select the source configuration: (1, 2, 3, 4): [1]
Select the destination bank: (A, B, F): [B]
Select the destination configuration: (1, 2, 3, 4): [1]
Copy SW configuration from: bank A, configuration 1
                           to: bank B, configuration 1.
/hd0/sys0/CONFIG0 --> /hd0/sys1/CONFIG0
```

Operation completed successfully.

If the copy fails you may receive one of the following messages:

**Error: Active bank cannot be overwritten or erased.**

You attempted to copy a configuration into the image currently in use by the MSS Server.

**Error: File copy failed.**

This condition occurs when the copy operation fails for reasons other than copying to the active configuration. The most common cause is specifying the same source and destination configurations. When you list (see "LIST" on page 7-9) the configurations, CORRUPT appears next to the bank that is damaged.

## DESCRIBE command

Use the **describe** command to display information about a stored image.

**Syntax:** describe

**Example:** Boot config>**describe**

BANK A	BANK B	BANK F
Product ID - 8210-MSS	Product ID - 8210-MSS	Product ID - 8210-MSS
Version 1 Release 1	Version 1 Release 1	Version 1 Release 1
Maint. 0 PTF 0	Maint. 0 PTF 0	Maint. 0 PTF 0
Feat. 8706 RPQ 0	Feat. 8706 RPQ 0	Feat. 8706 RPQ 0
Date 31 Dec 1996	Date 31 Dec 1996	Date 31 Dec 1996

### ERASE command

Use the **erase** command to erase a stored image or a configuration file.

```
Syntax: erase configuration [file]
        load [image]
```

config *or* load

Erases a configuration image or a boot image. Enter the config or the boot image number that contains the load after the **erase** command.

**Example:** Boot config>erase load

BankA	Description	Date
IMAGE - CORRUPT		01 Jan 1970 00:01
CONFIG 1 - AVAIL	test config for pubs	01 Jan 1970 01:26
CONFIG 2 - AVAIL *	test config for pubs	01 Jan 1970 01:13
CONFIG 3 - NONE		01 Jan 1970 00:58
CONFIG 4 - AVAIL		01 Jan 1970 00:39
BankB	Description	Date
IMAGE - ACTIVE		01 Jan 1970 00:01
CONFIG 1 - AVAIL	test config for pubs	01 Jan 1970 00:54
CONFIG 2 - AVAIL		01 Jan 1970 00:01
CONFIG 3 - AVAIL		01 Jan 1970 00:14
CONFIG 4 - ACTIVE *		01 Jan 1970 00:24
BankF	Description	Date
IMAGE - AVAIL		01 Jan 1970 00:01
CONFIG 1 - AVAIL	test config for pubs	01 Jan 1970 00:54
CONFIG 2 - AVAIL		01 Jan 1970 00:01
CONFIG 3 - AVAIL		01 Jan 1970 00:14
CONFIG 4 - AVAIL		01 Jan 1970 00:24

\* - Last Used Config      L - Config File is Locked

Select the bank to erase: (A, B, F): [A] a  
Erase SW load image from bank A.

Operation completed successfully.

Boot config>list

BankA	Description	Date
IMAGE - NONE		01 Jan 1970
CONFIG 1 - AVAIL	test config for pubs	01 Jan 1970 00:26
CONFIG 2 - AVAIL *	test config for pubs	01 Jan 1970 01:13
CONFIG 3 - AVAIL		01 Jan 1970 00:58
CONFIG 4 - AVAIL		01 Jan 1970 00:39
BankB	Description	Date
IMAGE - ACTIVE		01 Jan 1970
CONFIG 1 - AVAIL	test config for pubs	01 Jan 1970 00:54
CONFIG 2 - AVAIL		01 Jan 1970 00:01
CONFIG 3 - AVAIL		01 Jan 1970 00:14
CONFIG 4 - ACTIVE *		01 Jan 1970 00:24
BankF	Description	Date
IMAGE - AVAIL		01 Jan 1970
CONFIG 1 - AVAIL	test config for pubs	01 Jan 1970 00:54
CONFIG 2 - AVAIL		01 Jan 1970 00:01
CONFIG 3 - AVAIL		01 Jan 1970 00:14
CONFIG 4 - AVAIL		01 Jan 1970 00:24

\* - Last Used Config      L - Config File is Locked

## Change Management Commands

### Example: Boot config>erase configuration

BankA	Description	Date
IMAGE - NONE		01 Jan 1970 00:01
CONFIG 1 - AVAIL	test config for pubs	01 Jan 1970 00:26
CONFIG 2 - AVAIL *	test config for pubs	01 Jan 1970 01:13
CONFIG 3 - AVAIL		01 Jan 1970 01:26
CONFIG 4 - AVAIL		01 Jan 1970 01:39

BankB	Description	Date
IMAGE - ACTIVE		01 Jan 1970 00:01
CONFIG 1 - AVAIL	test config for pubs	01 Jan 1970 00:54
CONFIG 2 - AVAIL		01 Jan 1970 00:01
CONFIG 3 - AVAIL		01 Jan 1970 00:14
CONFIG 4 - ACTIVE *		01 Jan 1970 00:24

BankF	Description	Date
IMAGE - AVAIL		01 Jan 1970 00:01
CONFIG 1 - AVAIL	test config for pubs	01 Jan 1970 00:54
CONFIG 2 - AVAIL		01 Jan 1970 00:01
CONFIG 3 - AVAIL		01 Jan 1970 00:14
CONFIG 4 - AVAIL		01 Jan 1970 00:24

\* - Last Used Config      L - Config File is Locked

Select the source bank: (A, B, F): [A]  
Select the configuration to erase: (1, 2, 3, 4): [1] 3  
Erase SW configuration file from bank A, configuration 3.

Operation completed successfully.

Boot config>list

BankA	Description	Date
IMAGE - NONE		
CONFIG 1 - AVAIL	test config for pubs	01 Jan 1970 00:14
CONFIG 2 - AVAIL *	test config for pubs	01 Jan 1970 01:13
CONFIG 3 - NONE		01 Jan 1970 00:58
CONFIG 4 - AVAIL		01 Jan 1970 00:26

BankB	Description	Date
IMAGE - ACTIVE		01 Jan 1970
CONFIG 1 - AVAIL	test config for pubs	01 Jan 1970 00:54
CONFIG 2 - AVAIL		01 Jan 1970 00:01
CONFIG 3 - AVAIL		01 Jan 1970 00:14
CONFIG 4 - ACTIVE *		01 Jan 1970 00:24

BankF	Description	Date
IMAGE - AVAIL		01 Jan 1970
CONFIG 1 - AVAIL	test config for pubs	01 Jan 1970 00:54
CONFIG 2 - AVAIL		01 Jan 1970 00:01
CONFIG 3 - AVAIL		01 Jan 1970 00:14
CONFIG 4 - AVAIL		01 Jan 1970 00:24

\* - Last Used Config      L - Config File is Locked

Notice that the list command displays *NONE* by bank A, config 3.

If the erasure fails, a message indicating the failure appears on the console along with the banks that failed.

## LIST

Use the **list** command to display information about which load images and configuration files are available and active.

**Syntax:** `list`

**Example:** `Boot config>list`

```
+----- BankA -----+----- Description -----+----- Date -----+
| IMAGE - AVAIL                |                               | 01 Jan 1970          |
| CONFIG 1 - AVAIL             | test config for pubs         | 01 Jan 1970 00:26    |
| CONFIG 2 - AVAIL *           | test config for pubs         | 01 Jan 1970 01:13    |
| CONFIG 3 - AVAIL             |                               | 01 Jan 1970 00:58    |
| CONFIG 4 - AVAIL             |                               | 01 Jan 1970 00:39    |
+----- BankB -----+----- Description -----+----- Date -----+
| IMAGE - ACTIVE                |                               | 01 Jan 1970          |
| CONFIG 1 - AVAIL             | test config for pubs         | 01 Jan 1970 00:54    |
| CONFIG 2 - AVAIL             |                               | 01 Jan 1970 00:01    |
| CONFIG 3 - AVAIL             |                               | 01 Jan 1970 00:14    |
| CONFIG 4 - ACTIVE *          |                               | 01 Jan 1970 00:24    |
+----- BankF -----+----- Description -----+----- Date -----+
| IMAGE - AVAIL                |                               | 01 Jan 1970          |
| CONFIG 1 - AVAIL             | test config for pubs         | 01 Jan 1970 00:54    |
| CONFIG 2 - AVAIL             |                               | 01 Jan 1970 00:01    |
| CONFIG 3 - AVAIL             |                               | 01 Jan 1970 00:14    |
| CONFIG 4 - AVAIL             |                               | 01 Jan 1970 00:24    |
+-----+-----+-----+
* - Last Used Config      L - Config File is Locked
```

The following are the possible file status descriptors:

### ACTIVE

The file is currently loaded and is running on the 8210

### AVAIL

This is a valid file that can be made ACTIVE.

### CORRUPT

The file was damaged or not loaded into the 8210 completely. The file must be replaced.

### LOCAL

The file will be used only on the next reload or reset. After the file is used, it will be placed in AVAIL state.

### PENDING

This file will be loaded on the next reload, reset, or power-up of the 8210.

## LOCK

Use the **lock** command to prevent the device from overwriting the selected configuration with any other configuration.

**Syntax:** `lock`

**Example:** `Boot config>lock`

BankA	Description	Date
IMAGE - NONE		01 Jan 1970 01:03
CONFIG 1 - AVAIL	test config for pubs	01 Jan 1970 00:26
CONFIG 2 - AVAIL *	test config for pubs	01 Jan 1970 01:13
CONFIG 3 - NONE		01 Jan 1970 00:58
CONFIG 4 - AVAIL		01 Jan 1970 00:26

BankB	Description	Date
IMAGE - ACTIVE		01 Jan 1970 00:01
CONFIG 1 - AVAIL	test config for pubs	01 Jan 1970 00:54
CONFIG 2 - AVAIL		01 Jan 1970 00:01
CONFIG 3 - AVAIL		01 Jan 1970 00:14
CONFIG 4 - ACTIVE *		01 Jan 1970 00:24

BankF	Description	Date
IMAGE - AVAIL		01 Jan 1970 00:01
CONFIG 1 - AVAIL	test config for pubs	01 Jan 1970 00:54
CONFIG 2 - AVAIL		01 Jan 1970 00:01
CONFIG 3 - AVAIL		01 Jan 1970 00:14
CONFIG 4 - AVAIL		01 Jan 1970 00:24

\* - Last Used Config      L - Config File is Locked

Select the source bank: (A, B, F): [A]  
 Select the source configuration: (1, 2, 3, 4): [1] 4  
 Attempting to lock bank A and configuration 4.

Operation completed successfully.

`Boot config>list`

BankA	Description	Date
IMAGE - NONE		01 Jan 1970
CONFIG 1 - AVAIL	test config for pubs	01 Jan 1970 00:13
CONFIG 2 - AVAIL *	test config for pubs	01 Jan 1970 01:13
CONFIG 3 - NONE		01 Jan 1970 00:58
CONFIG 4 - AVAIL L		01 Jan 1970 00:26

BankB	Description	Date
IMAGE - ACTIVE		01 Jan 1970 00:01
CONFIG 1 - AVAIL	test config for pubs	01 Jan 1970 00:54
CONFIG 2 - AVAIL		01 Jan 1970 00:01
CONFIG 3 - AVAIL		01 Jan 1970 00:14
CONFIG 4 - ACTIVE *		01 Jan 1970 00:24

BankB	Description	Date
IMAGE - AVAIL		01 Jan 1970 00:01
CONFIG 1 - AVAIL	test config for pubs	01 Jan 1970 00:54
CONFIG 2 - AVAIL		01 Jan 1970 00:01
CONFIG 3 - AVAIL		01 Jan 1970 00:14
CONFIG 4 - AVAIL		01 Jan 1970 00:24

\* - Last Used Config      L - Config File is Locked



# SET command

Use the **set** command to select the code bank and the configuration to use and the duration of use. The valid durations are:

**once** The configuration is active for the next boot only.

**always** The configuration is active for all subsequent boots until changed again.

**Syntax:** `set`

**Example:** `Boot config>set`

BankA	Description	Date
IMAGE - NONE		01 Jan 1970 01:03
CONFIG 1 - AVAIL	test config for pubs	01 Jan 1970 00:13
CONFIG 2 - AVAIL *	test config for pubs	01 Jan 1970 01:13
CONFIG 3 - NONE		01 Jan 1970 00:58
CONFIG 4 - AVAIL		01 Jan 1970 00:26
BankB	Description	Date
IMAGE - ACTIVE		01 Jan 1970 00:01
CONFIG 1 - AVAIL	test config for pubs	01 Jan 1970 00:54
CONFIG 2 - AVAIL		01 Jan 1970 00:01
CONFIG 3 - AVAIL		01 Jan 1970 00:14
CONFIG 4 - ACTIVE *		01 Jan 1970 00:24
BankF	Description	Date
IMAGE - AVAIL		01 Jan 1970 00:01
CONFIG 1 - AVAIL	test config for pubs	01 Jan 1970 00:54
CONFIG 2 - AVAIL		01 Jan 1970 00:01
CONFIG 3 - AVAIL		01 Jan 1970 00:14
CONFIG 4 - AVAIL		01 Jan 1970 00:24

\* - Last Used Config      L - Config File is Locked

Select the source bank: (A, B, F): [A] b  
 Select the source configuration: (1, 2, 3, 4): [1] 4  
 Select the duration to use for booting: (once, always): [always]  
 Set SW to boot using bank B and configuration 4, always.

Operation completed successfully.

`Boot config>list`

BankA	Description	Date
IMAGE - NONE		01 Jan 1970
CONFIG 1 - AVAIL	test config for pubs	01 Jan 1970 00:13
CONFIG 2 - AVAIL *	test config for pubs	01 Jan 1970 01:13
CONFIG 3 - NONE		01 Jan 1970 00:58
CONFIG 4 - AVAIL		01 Jan 1970 00:26
BankB	Description	Date
IMAGE - ACTIVE		01 Jan 1970
CONFIG 1 - AVAIL	test config for pubs	01 Jan 1970 00:54
CONFIG 2 - AVAIL		01 Jan 1970 00:01
CONFIG 3 - AVAIL		01 Jan 1970 00:14
CONFIG 4 - ACTIVE *		01 Jan 1970 00:24
BankF	Description	Date
IMAGE - AVAIL		01 Jan 1970
CONFIG 1 - AVAIL	test config for pubs	01 Jan 1970 00:54
CONFIG 2 - AVAIL		01 Jan 1970 00:01
CONFIG 3 - AVAIL		01 Jan 1970 00:14
CONFIG 4 - AVAIL		01 Jan 1970 00:24

\* - Last Used Config      L - Config File is Locked

## Change Management Commands

### TFTP command

Use the **tftp** command to initiate TFTP file transfers between 8210 remote servers.

#### Syntax:

```
tftp get config
      load

      put config
      load
```

#### Example: Boot config>tftp get load

BankA	Description	Date
IMAGE - NONE		01 Jan 1970 01:03
CONFIG 1 - AVAIL	test config for pubs	01 Jan 1970 00:01
CONFIG 2 - AVAIL *	test config for pubs	01 Jan 1970 01:13
CONFIG 3 - NONE		01 Jan 1970 00:58
CONFIG 4 - AVAIL		01 Jan 1970 00:14

BankB	Description	Date
IMAGE - ACTIVE		01 Jan 1970 00:01
CONFIG 1 - AVAIL	test config for pubs	01 Jan 1970 00:54
CONFIG 2 - AVAIL		01 Jan 1970 00:01
CONFIG 3 - AVAIL		01 Jan 1970 00:14
CONFIG 4 - ACTIVE *		01 Jan 1970 00:24

BankF	Description	Date
IMAGE - AVAIL		01 Jan 1970 00:01
CONFIG 1 - AVAIL	test config for pubs	01 Jan 1970 00:54
CONFIG 2 - AVAIL		01 Jan 1970 00:01
CONFIG 3 - AVAIL		01 Jan 1970 00:14
CONFIG 4 - ACTIVE *		01 Jan 1970 00:24

\* - Last Used Config      L - Config File is Locked

```
Specify the server IP address (dotted decimal): : [1.2.3.4] 192.9.200.1
Specify the remote file name: : (load.img) /usr/8210load/nce.img
Select the destination bank: (A, B, F): [A] a
TFTP SW load image
get: /usr/8210load/nce.img
from: 192.9.200.1
to: bank A.
```

Operation completed successfully.

### UNLOCK

Use the **unlock** command to allow the device to overwrite the selected configuration that was previously locked.

#### Syntax: unlock

#### Example: Boot config>unlock

```

+----- BankA -----+----- Description -----+----- Date -----+
| IMAGE - NONE                |                               | 01 Jan 1970 01:03 |
| CONFIG 1 - AVAIL            | test config for pubs         | 01 Jan 1970 00:13 |
| CONFIG 2 - AVAIL *          | test config for pubs         | 01 Jan 1970 01:13 |
| CONFIG 3 - NONE              |                               | 01 Jan 1970 00:58 |
| CONFIG 4 - AVAIL            |                               | 01 Jan 1970 00:26 |
+----- BankB -----+----- Description -----+----- Date -----+
| IMAGE - ACTIVE               |                               | 01 Jan 1970 00:01 |
| CONFIG 1 - AVAIL            | test config for pubs         | 01 Jan 1970 00:54 |
| CONFIG 2 - AVAIL            |                               | 01 Jan 1970 00:01 |
| CONFIG 3 - AVAIL            |                               | 01 Jan 1970 00:14 |
| CONFIG 4 - ACTIVE *         |                               | 01 Jan 1970 00:24 |
+----- BankF -----+----- Description -----+----- Date -----+
| IMAGE - AVAIL                |                               | 01 Jan 1970 00:01 |
| CONFIG 1 - AVAIL            | test config for pubs         | 01 Jan 1970 00:54 |
| CONFIG 2 - AVAIL            |                               | 01 Jan 1970 00:01 |
| CONFIG 3 - AVAIL            |                               | 01 Jan 1970 00:14 |
| CONFIG 4 - AVAIL            |                               | 01 Jan 1970 00:24 |
+-----+-----+-----+
* - Last Used Config      L - Config File is Locked

```

```

Select the source bank: (A, B): [A]
Select the source configuration: (1, 2, 3, 4): [1] 4
Attempting to unlock bank A and configuration 4.

```

Operation completed successfully.

Boot config>**list**

```

+----- BankA -----+----- Description -----+----- Date -----+
| IMAGE - NONE                |                               | 01 Jan 1970 00:01 |
| CONFIG 1 - AVAIL            | test config for pubs         | 01 Jan 1970 01:13 |
| CONFIG 2 - AVAIL *          | test config for pubs         | 01 Jan 1970 00:58 |
| CONFIG 3 - NONE              |                               | 01 Jan 1970 00:14 |
| CONFIG 4 - AVAIL            |                               | 01 Jan 1970 00:14 |
+----- BankB -----+----- Description -----+----- Date -----+
| IMAGE - ACTIVE               |                               | 01 Jan 1970      |
| CONFIG 1 - AVAIL            | test config for pubs         | 01 Jan 1970 00:54 |
| CONFIG 2 - AVAIL            |                               | 01 Jan 1970 00:01 |
| CONFIG 3 - AVAIL            |                               | 01 Jan 1970 00:14 |
| CONFIG 4 - ACTIVE *         |                               | 01 Jan 1970 00:24 |
+----- BankF -----+----- Description -----+----- Date -----+
| IMAGE - AVAIL                |                               | 01 Jan 1970      |
| CONFIG 1 - AVAIL            | test config for pubs         | 01 Jan 1970 00:54 |
| CONFIG 2 - AVAIL            |                               | 01 Jan 1970 00:01 |
| CONFIG 3 - AVAIL            |                               | 01 Jan 1970 00:14 |
| CONFIG 4 - ACTIVE *         |                               | 01 Jan 1970 00:24 |
+-----+-----+-----+
* - Last Used Config      L - Config File is Locked

```

## Exit

Use the **exit** command to leave the current process command level and return to the previous process level.

**Syntax:** exit

**Example:** **exit**

## Change Management Commands

---

## Chapter 8. Accessing the Firmware from the Command Line Interface

This section covers boot options that can be set from the Firmware and Operational command prompt. For information about file transfer and file management, refer to *IBM Nways Multiprotocol Switched Services (MSS) Server Module Planning and Setup Guide*

The 8210 is designed to boot from one of the integrated image banks. With the hard drive installed, the 8210 has at least three image banks that can be used to IML or boot the device. The 8210 also has options to come up in Attended or Unattended mode. Attended mode requires direct interaction with a user at a console attached on the serial port.

The 8210 can be booted using any of the following methods:

- Flash memory, known as Bank F
- Hard drive, known as Bank A and B

---

### Accessing the Firmware Prompt

Before booting the 8210, note the following:

- You will need a terminal or IP workstation connected to the 8210. This can be a VT100 TTY device connected directly through the serial port. You can connect an IP workstation using SLIP to connect into the 8210. The default 8210 IP address is 10.1.1.2 and the workstation address should be 10.1.1.3.
- The 8210 is shipped with code loaded in flash memory and on the hard drive.

**Important:** To access the Firmware prompt, you can stop the 8210 boot; to stop it, you must have a TTY console directly attached to the serial port. When the 8210 starts its boot sequence, press **Ctrl C** from the console to interrupt the boot sequence.

Another way to control booting is to configure the 8210 to come up in Attended mode. Attended mode can be configured from the Firmware command set.

---

### Boot Options Available for the 8210

The 8210 can be configured for Unattended mode. In Unattended mode, you must have chosen which load image and which configuration to load. You are provided with three banks to choose among. The structure of the image banks is as follows:

- IMAGE - Status of image
- CONFIG 1 - Status of Config
- CONFIG 2 - Status of Config
- CONFIG 3 - Status of Config
- CONFIG 4 - Status of Config

See "LIST" on page 7-9 for a description of file statuses.

## Accessing Firmware

### Attended Mode

When the 8210 is configured to come up in Attended mode, you are given access to the Firmware command set. From this level of commands, you can select the Image Bank from which to load and the config. You can at this point load new config files or image files. This connection is either a TTY or Telnet connection. You can transfer files using the Xmodem protocol for TTY or TFTP for IP connections.

In Attended mode, you can start booting the 8210 by pressing **F9** or **<Esc>9** to start the operating system.

### Unattended Mode

This is the normal mode for the 8210. It will come up on the Active, Local, or Pending image and config based on your choice.

## Chapter 9. The GWCON (Monitoring) Process and Commands

This chapter describes the GWCON process and includes the following sections:

- “What is GWCON?”
- “Entering and Exiting GWCON” on page 9-2
- “GWCON Commands” on page 9-2

### What is GWCON?

The Gateway Console (monitoring) process, GWCON (also referred to as CGWCON), is a second-level process of the router user interface.

Using GWCON commands, you can:

- List the protocols and interfaces currently configured in the router.
- Display memory and network statistics.
- Set current Event Logging System (ELS) parameters.
- Test a specified network interface.
- Communicate with third-level processes, including protocol environments.
- Enable and disable interfaces.

GWCON fits into the router software structure as shown in Figure 9-1.

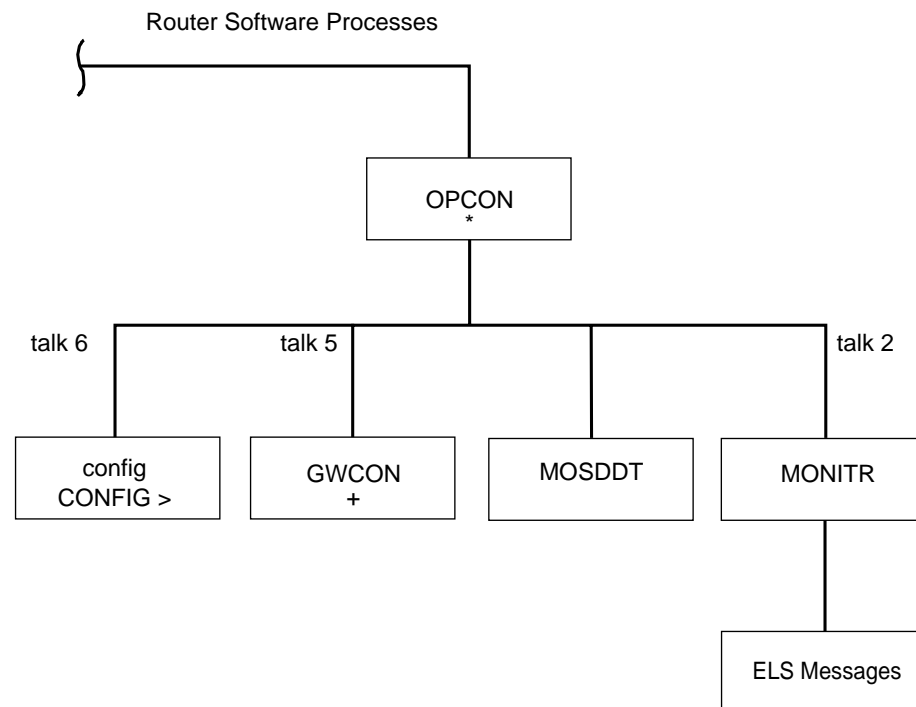

Figure 9-1. GWCON in the Router Software Structure

The GWCON command interface is made up of levels called modes. Each mode has its own prompt. For example, the prompt for the IP protocol is IP>.

## GWCON (Monitoring) Process and Commands

If you want to know the process and mode you are communicating with, press **Return** to display the prompt. Some commands in this chapter, such as the **network** and **protocol** commands, allow you to access the various modes in GWCON.

---

### Entering and Exiting GWCON

To enter the GWCON command environment from OPCON and obtain the GWCON prompt:

1. At the OPCON prompt, enter the **status** command to find the process ID (PID) of GWCON.

\* **status**

For sample output of the status command see “Status” on page 5-8.

2. Enter the **talk** command and the PID for GWCON to get to the GWCON prompt.

\* **talk 5**

The console displays the GWCON prompt (+). If the prompt does not appear, press **Return**. Now, you can enter GWCON commands.

To return to OPCON, enter the OPCON intercept character. (The default is **Ctrl P**.)

---

### GWCON Commands

This section contains the GWCON commands. Each command includes a description, syntax requirements, and an example. The GWCON commands are summarized in Table 9-1.

To use the GWCON commands, access the GWCON process by entering **talk 5** and enter the GWCON commands at the (+) prompt.

*Table 9-1 (Page 1 of 2). GWCON Command Summary*

Command	Function
<b>? (Help)</b>	Lists the GWCON commands.
<b>Buffer</b>	Displays information about packet buffers assigned to each interface.
<b>Clear</b>	Clears network statistics.
<b>Configuration</b>	Lists status of the current protocols and interfaces.
<b>Disable</b>	Takes the specified interface off line.
<b>Error</b>	Displays error counts.
<b>Event</b>	Enters the Event Logging System environment.
<b>Feature</b>	Provides access to console commands for independent router features outside the usual protocol and network interface console processes.
<b>Interface</b>	Displays network hardware statistics or statistics for the specified interface.
<b>Memory</b>	Displays memory, buffer, and packet data.



Table 9-1 (Page 2 of 2). GWCON Command Summary	
Command	Function
<b>Network</b>	Enters the console environment of the specified network.
<b>Protocol</b>	Enters the command environment of the specified protocol.
<b>Queue</b>	Displays buffer statistics for a specified interface.
<b>Statistics</b>	Displays statistics for a specified interface.
<b>Test</b>	Enables a disabled interface or tests the specified interface.

## ? (Help)

Use the **? (help)** command to list the commands that are available from the current prompt level. You can also enter a **?** after a specific command name to list its options.

**Syntax:** ?

**Example:** ?

```

BUFFER statistics
CLEAR statistics
CONFIGURATION of gateway
DISABLE interface
ERROR counts
EVENT logging
FEATURE commands
INTERFACE statistics
MEMORY statistics
NETWORK commands
PROTOCOL commands
QUEUE lengths
STATISTICS of network
TEST network
    
```

**Example:** protocol ?

```

IP
ARP
IPX
SNMP
OSPF
ASRT
HST
    
```

## Buffer

Use the **buffer** command to display information about packet buffers assigned to each interface.

**Note:** Each buffer on a device is the same size and is dynamically built. Buffers vary in size from one device to another.

To display information about one interface only, enter the interface or network number as part of the command. To obtain the interface number, use the GWCON **configuration** command.

**Syntax:** buffer network#

```

          Input Buffers:      Buffer sizes:
Nt Interface Req Alloc Low Curr Hdr Wrap Data Trail Total Bytes Alloc
0  ATM/0      20  20   7   0 109  92  2052   7  2260  45200
    
```

*Nt* Network interface number associated with the software.

## GWCON (Monitoring) Process and Commands

*Interface* Type of interface.

### **Input Buffers:**

*Req* Number of buffers requested.

*Alloc* Number of buffers allocated.

*Low* Low water mark (flow control).

*Curr* Current number of buffers on this device. The value will be 0 if the device is disabled. When a packet is received, if the value of *Curr* is below *Low*, then the packet is eligible for flow control. (See the **queue** command for conditions.)

### **Buffer Sizes:**

*Hdr* Sum of the maximum hardware, MAC, and data link headers.

*Wrap* Allowance given for MAC, LLC, or Network layer headers due to protocol wrapping.

*Data* Maximum data link layer packet size.

*Trail* Sum of the largest MAC and hardware trailers.

*Total* Overall size of each packet buffer.

*Bytes Alloc* Amount of buffer memory for this device. This value is determined by multiplying the values of *Alloc* x *Total*.

## Clear

Use the **clear** command to delete statistical information about one or all of the router's network interfaces. This command is useful when tracking changes in large counters. Using this command does not save space or speed up the router.

Enter the interface (or net) number as part of the command. To get the interface number, use the GWCON **configuration** command.

**Syntax:** `clear interface#`

**Example:** `clear 1`

Clear network statistics? (Yes or No):\_\_

## Configuration

Use the **configuration** command to display information about the protocols and network interfaces. The output is displayed in three sections, the first section lists the router identification, software version, boot ROM version, and the state of the auto-boot switch. The second and third sections list the protocol and interface information.

**Syntax:** `configuration`

**Example:** `configuration`

```
Nways 8210 Multiprotocol Switching Server
Host name: [not configured]
Version: 1.0

Num Name Protocol
0 IP DOD-IP
3 ARP Address Resolution
11 SNMP Simple Network Management Protocol
12 OSPF Open SPF-Based Routing Protocol
23 ASRT Adaptive Source Routing Transparent Enhanced Bridge

Num Name Feature
2 MCF MAC Filtering
6 QOS Quality of Service

1 Networks:
Net Interface MAC/Data-Link Hardware State
0 ATM/0 ATM CHARM ATM Up
```

- The first line lists the product name.
- The second line indicates whether a host name is configured.
- The third line lists the program/product number, Feature Number, Version, Release, PTF and RPQ information.
- The configured protocols are listed, followed by the configured features.

**Protocols:**

*Num*  
Number that is associated with the protocol.

*Name*  
Abbreviated name of the protocol.

*Protocol*  
Full name of the protocol.

**Features:**

*Num*  
Number associated with the feature.

*Name*  
Abbreviated name of the feature.

*Feature*  
Full name of the feature.

**Networks:**

*Net*  
Network number that the software assigns to the interface. Networks are numbered starting at 0. These numbers correspond to the interface numbers discussed under the CONFIG process.

*Interface*  
Name of the interface and the connector number on the card that the interface uses.

## GWCON (Monitoring) Process and Commands

### *MAC/Data Link*

Type of MAC/Data link configured for the interface.

### *Hardware*

Specific kind of interface by hardware type.

### *State*

Current state of the network interface.

**Testing** – indicates that the interface is undergoing a self-test. Occurs when the router is first started and when a problem is detected on the interface. Once the interface is inserted into the network, the interface periodically sends out test packets to ensure the interface is still functioning properly. If the test fails, the interface is removed from the network and the self-test is run to ensure its integrity. If a failure occurs during self-test, the network is declared down. If the self-test is successful, the network is declared up.

**Up** – indicates the interface is operational and connected.

**Down** indicates that the interface is not operational and has failed a self-test. The network will be retested at intervals beginning at 5 seconds increasing until the router does not test the interface any more (approximately 2 minutes).

**Disabled** – indicates that the interface is either temporarily or permanently disabled by either the GWCON **disable** command or the CONFIG **disable** command. The GWCON **disable** command is temporary and goes away when the router is reinitialized. The CONFIG **disable** command is permanent and stays when the router is reinitialized. You can enable the network with the GWCON **test** command.

**Not installed** – indicates that no interface is present in the router, or the board is improperly configured.

## Disable

Use the **disable** command to take a network interface off-line, making the interface unavailable. This command immediately disables the interface. You are not prompted to confirm, and no verification message displays. If you disable an interface with this command, it remains disabled until you use the GWCON **test** command or an OPCON **restart** or **reload** command to enable it.

Enter the interface, or net number as part of the command. To obtain the interface number, use the GWCON **configuration** command.

**Note:** This command may not be accepted during interface self-testing. In this case, one of the following messages will be displayed:

```
Network is already undergoing test, cancelling further testing  
Network is already undergoing test, cannot disable now
```

Try the **disable** command again later.

**Syntax:**     disable     interface#

**Example:**    disable 1

## Environment

**Note:** Invoke this command *only* for routers with two service ports.

Displays the ENV> prompt, which has three available commands: **list**, **reset-max-min**, and **exit**. Type **exit** to return to the + prompt.

In extreme temperature conditions, the temperature chip holds the router in a reset state, preventing it from operating. To ensure correct operation of the router due to temperature conditions, the temperature chip allows the router to operate in a range that is equal to or greater than -55 degrees Celsius and less than or equal to 85 degrees Celsius. This is not the operational range.

The temperature chip shuts off the router at 85 degrees or above and does not come back on until it is 80 degrees or below. Only heat affects the chip. It does not cause the router to reset on cold conditions. Minus 55 degrees Celsius is the lowest temperature the chip registers.

**Syntax:** `environment`

**Example:** `environment`  
Environment System user console  
ENV>

The **list** command displays a status screen with the current temperature, the amount of time between successive temperature readings, the noted maximum and minimum seen since the last reset/clear, and alerts when the temperature threshold, high or low, has been passed, as well as the hysteresis value.

### Example: list

```
Time: 14:23:12    Sunday, January 09 2011

Current Ambient Temperature: 44C (111F)

Recalculate temperature approx. every 60 seconds.

Maximum: 48C (118F) at 11:47:32    Friday,    January 07 2011
Minimum: 40C (104F) at 15:24:21    Saturday, January 08 2011
Last Max/Min Reset: 09:21:17    Thursday, January 06 2011

High Temperature Alarm Threshold: 85C (185F)
Low Temperature Alarm Threshold: -55C (-67F)
(Hysteresis value: +/- 5C)
```

The **reset-max-min** command sets the value of the last recorded maximum and minimum to the current temperature. This is similar to resetting a standard high-low thermometer.

### Example reset-max-min

```
Maximum and Minimum Temperature reset to current ambient temperature: 44C (111F)
```

## GWCON (Monitoring) Process and Commands

### Error

Use the **error** command to display error statistics for the network. This command provides a group of error counters.

**Syntax:** `error`

**Example:** `error`

<i>Nt</i>	<i>Interface</i>	<i>Input Discards</i>	<i>Input Errors</i>	<i>Input Unk Proto</i>	<i>Input Flow Drop</i>	<i>Output Discards</i>	<i>Output Errors</i>
0	ATM/0	0	0	0	0	0	0

*Nt* Network interface number associated with the software.

*Interface* Type of interface.

*Input Discards* Number of inbound packets which were discarded even though no errors were detected to prevent their being deliverable to a higher-layer protocol. The packets may have been discarded to free buffer space.

*Input Errors* Number of packets that were found to be defective at the data link.

*Input Unk Proto* Number of packets received for an unknown protocol.

*Input Flow Drop* Number of packets received that are flow controlled on output.

*Output Discards* Number of packets that the router chose to discard rather than transmit due to flow control.

*Output Errors* Number of output errors, such as attempts to send over a network that is down or over a network that went down during transmission.

**Note:** The sum of the discarded output packets is not the same as input flow drops over all networks. Discarded output may indicate locally originated packets.

### Event

Use the **event** command to access the Event Logging System (ELS) console environment. This environment is used to set up temporary message filters for troubleshooting purposes. All changes made in the ELS console environment will take effect immediately, but will go away when the router is reinitialized. See Chapter 11, "Using and Configuring the Event Logging System (ELS)" for information about the Event Logging System and its commands. Use the **exit** command to return to the GWCON process.

**Syntax:** `event`

**Example:** `event`

### Feature

Use the **feature** command to access console commands for specific IBM 8210 features outside of the protocol and network interface console processes.

Enter a question mark after the **feature** command to obtain a listing of the features available for your software release. For example:

`feature ?`

To access that feature's console prompt, enter the **feature** command at the GWCON prompt followed by the feature number or short name. Table 6-4 on page 6-16 lists available feature numbers and names.

Once you access the prompt for that feature, you can begin entering specific commands to monitor that feature. To return to the GWCON prompt, enter the **exit** command at the feature's console prompt.

**Syntax:** `feature feature# OR feature-short-name`

**Example:** `feature mcf`  
 Reservation console>

## Interface

Use the **interface** command to display statistical information about the network interfaces (for example, Ethernet or Token-Ring). This command can be used without a qualifier to provide a summary of all the interfaces (shown in the following output) or with a qualifier to reveal detailed information of one specific interface.

Descriptions of detailed output for each type of interface are provided in the specific interface *Monitoring* chapters found in this guide. To obtain the interface number, use the GWCON **configuration** command.

**Syntax:** `interface interface#`

**Example:** `interface`

Nt	Interface	Slot-Port	Port Name	Self-Test		Maintenance
				Passed	Failed	Failed
0	ATM/0	Slot:1	Port:1	1	0	0

**Note:** The display varies depending on the device.

- Nt* Global interface number.
- Interface* Interface name.
- Slot-Port* Slot number and port number of the interface.
- Port Name* Port number, if applicable on the slot.
- Self-Test Passed* Number of times self-test succeeded (state of interface changes from down to up).
- Self-Test Failed* Number of times self-test failed (state of interface changes from up to down).
- Maintenance Failed* Number of maintenance failures.

## Memory

Use the **memory** command to display the current CPU memory usage in bytes, the number of buffers, and the packet sizes.

To use this command, free memory must be available. The number of free packet buffers may drop to zero, resulting in the loss of some incoming packets; however, this does not adversely affect router operations. The number of free buffers should remain constant when the router is idle. If it does not, contact your service representative.

**Syntax:** `memory`

**Example:** `memory`

	Total	Reserve	Never Alloc	Perm Alloc	Temp Alloc	Prev Alloc
Heap memory	5463895	201824	5065383	328344	375856	22656

Number of global buffers: Total = 294, Free = 287, Fair = 57, Low = 58  
 Global buff size: Data = 4478, Header = 128, Wrap = 92, Trailer = 19  
 Total = 4700

- Heap memory:* Amount of memory used to dynamically allocate data structures.
- Total* Total amount of space available for allocation for memory.
- Reserve* Minimum amount of memory needed by the currently configured protocols and features.
- Never Alloc* Memory that has never been allocated.
- Perm Alloc* Memory requested permanently by router tasks.
- Temp Alloc* Memory allocated temporarily to router tasks.
- Prev Alloc* Memory allocated temporarily and returned.
- Number of global buffers:*
- Total* Total number of global buffers in the system.
- Free* Number of global buffers available.
- Fair* Fair number of buffers for each interface. (See Low below.)
- Low* The number of free buffers at which the allocation strategy changes to conserve buffers. If the value of *Free* is less than *Low*, then buffers will not be placed on any queue that has more than the *Fair* number of buffers in it.
- Global buff size:*
- Data* Maximum data link packet size of any interface.
- Header* Sum of the maximum hardware, MAC, and data link headers.
- Wrap* Allowance given for MAC, LLC, or Network layer headers due to protocol wrapping.
- Trailer* Sum of the largest MAC and hardware trailers.
- Total* Overall size of each packet buffer



## Network

Use the **network** command to enter the console environment for supported networks, such as ATM networks. This command obtains the console prompt for the specified interface. From the prompt, you can display statistical information, such as the LAN Emulation Clients for ATM networks.

At the GWCON prompt (+), enter the **configuration** command to see the protocols and networks for which the router is configured. See “Configuration” on page 9-4 for more information on the configuration command.

Enter **interface** at the + prompt for a display of the networks for which the router is configured.

Enter the GWCON **network** command and the number of the interface you want to monitor. For example:

```
+network 0  
ATM+
```

In the example, the ATM+ prompt is displayed. You can then view information about the ATM interface by entering the ATM monitoring commands.

## GWCON (Monitoring) Process and Commands

### Exiting the Interface Console Process

To exit the interface console process and return to the OPCON process:

1. Return to the GWCON process by entering the **exit** command. For example:

```
ATM+ exit
```

2. Return to the OPCON process by entering the OPCON intercept character. (**Ctrl P** is the default intercept character.)

After identifying the interface number of the interface you want to monitor, for interface-specific information, see the monitoring chapter in this manual for the specified network or link-layer interface. Console support is offered for the following network and link-layer interfaces:

- ATM
- Token Ring LECs
- Ethernet LECs
- ATM
- ISDN

**Syntax:**     network *interface#*

**Example:**   **network 0**

```
ATM+
```

## Protocol

Use the **protocol** command to communicate with the router software that implements the network protocols installed in your router. The **protocol** command accesses a protocol's command environment. After you enter this command, the prompt of the specified protocol appears. From the prompt, you can enter commands that are specific to that protocol.

Enter the protocol number or short name as part of the command. To obtain the protocol number or short name, enter the CONFIG command environment (Config>), and then enter the **list configuration** command. See "Entering and Exiting CONFIG" on page 6-6 for instructions on accessing Config>. To return to GWCON, enter **exit**.

See the corresponding monitoring chapter in this manual or in the *Multiprotocol Switched Services (MSS) Server Command Line Interface Volume 2* for information on a specific protocol's console commands.

**Syntax:**     protocol *prot#*

**Example:**   **protocol 7**

```
IPX>
```

The following table lists examples of protocol numbers and names.

Protocol Number	Protocol Short Name	Accesses the following protocol process
0	IP	IP (Internet Protocol)
3	ARP	ARP (Address Resolution Protocol)
7	IPX	IPX (Novell NetWare Internetwork Packet Exchange)
11	SNMP	SNMP (Simple Network Management Protocol)
12	OSPF	OSPF (Open Shortest Path First)
23	ASRT	Adaptive Source Routing Transparent Bridge
24	HST	TCP/IP Host Services

## Queue

Use the **queue** command to display statistics about the length of input and output queues on the specified interfaces. Information about input and output queues provided by the queue command includes:

- The total number of buffers allocated
- The low-level buffer value
- The number of buffers currently active on the interface.

To display information about one interface only, enter the interface or network number as part of the command. To obtain the interface number, use the GWCON **configuration** command.

**Syntax:** `queue interface#`

**Example:** `queue`

Nt	Interface	Input Queue			Output Queue	
		Alloc	Low	Curr	Fair	Curr
0	ATM/0	30	10	30	30	1

*Nt* Network interface number associated with the software.

*Interface* Type of interface.

*Input Queue:*

*Alloc* Number of buffers allocated to this device.

*Low* Low water mark for flow control on this device.

*Curr* Current number of buffers on this device. The value will be 0 if the device is disabled.

*Output Queue:*

*Fair* Fair level for the length of the output queue on this device.

*Curr* Number of packets currently waiting to be transmitted on this device. For locally originated packets, the eligibility discard depends on the global low water mark described in the **memory** command.

The router attempts to keep at least the Low value packets available for receiving over an interface. If a packet is received and the value of Curr is less than Low, then the packet will be subject to flow control. If a buffer subject to flow control is to be queued on this device and the Curr level is greater than Fair, then the buffer

## GWCON (Monitoring) Process and Commands

is dropped instead of queued. The dropped buffer is displayed in the Output Discards column of the **error** command. It will also generate ELS event GW.036 or GW.057.

Due to the scheduling algorithms of the router, the dynamic numbers of Curr (particularly the Input Queue Curr) may not be fully representative of typical values during packet forwarding. The console code runs only when the input queues have been drained. Thus, Input Queue Curr will generally be nonzero only when those packets are waiting on slow transmit queues.

## Statistics

Use the **statistics** command to display statistical information about the network software, such as the configuration of the networks in the router.

To display information about one interface only, enter the interface or network number as part of the command. To obtain the interface number, use the GWCON **configuration** command.

**Syntax:** `statistics interface#`

**Example:** `statistics`

Nt	Interface	Unicast Pkts Rcv	Multicast Pkts Rcv	Bytes Received	Packets Trans	Bytes Trans
0	ATM/0	479	0	19730	479	20292

*Nt* Network interface number associated with the software.

*Interface* Type of interface.

*Unicast Pkts Rcv* Number of non-multicast, non-broadcast specifically-addressed packets at the MAC layer.

*Multicast Pkts Rcv* Number of multicast or broadcast packets received.

*Bytes Received* Number of bytes received at this interface at the MAC layer.

*Packets Trans* Number of packets of unicast, multicast, or broadcast type transmitted.

*Bytes Trans* Number of bytes transmitted at the MAC layer.

## Test

Use the **test** command to verify the state of an interface or to enable an interface that was previously disabled with **disable** command. If the interface is enabled and passing traffic, the **test** command will remove the interface from the network and run self-diagnostic tests on the interface.

Enter the interface or network number as part of the command. To obtain the interface number, use the GWCON **configuration** command. When testing starts, the console displays the following message:

```
Testing net 0 ATM/0...
```

When testing completes, fails, or GWCON times out (after 30 seconds), the following possible messages are displayed:

```
Testing net 0 ATM/0 ...successful
Testing net 0 ATM/0 ...failed
Testing net 0 ATM/0 ...still testing
Network is already undergoing test, attempting restart
```

Some interfaces may take more than 30 seconds before testing is done.

**Syntax:**    test *interface#*

**Example:**   **test 0**

**Note:** For this command to work, you must enter the **complete** spelling of the command followed by the interface number.

## GWCON (Monitoring) Process and Commands

## Chapter 10. The MONITR Process

This chapter explains how to use the MONITR process and how to control the way MONITR collects and displays messages. (Refer to Chapter 11, "Using and Configuring the Event Logging System (ELS)" for information about ELS and message formats. Refer also to the *IBM 8210 Multiprotocol Switched Services Server Event Logging System Messages Guide* for a description of each message.) This chapter includes the following sections:

- "What is MONITR?"
- "Commands Affecting MONITR" on page 10-2
- "Entering and Exiting MONITR" on page 10-2
- "Receiving MONITR Messages" on page 10-2

### What is MONITR?

The MONITR process provides a view of activity inside the router and the networks. MONITR also displays logging messages from software that still uses the old logging system. MONITR fits into the router software structure as shown in Figure 10-1.

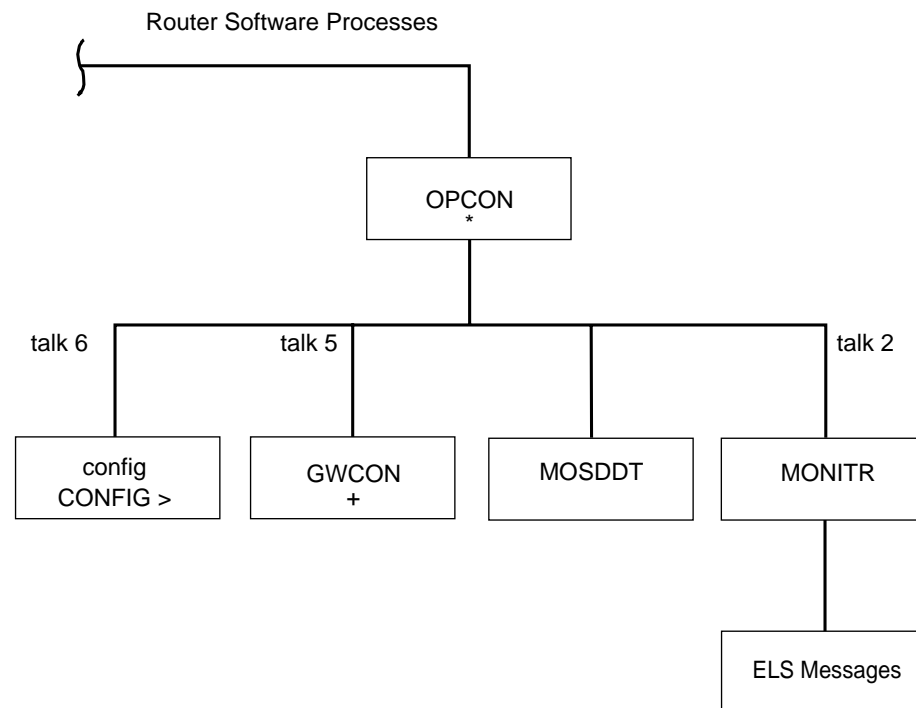

Figure 10-1. MONITR in the Router Software Structure

---

### Commands Affecting MONITR

The following commands affect the MONITR process:

- OPCODE commands:
  - **divert** temporarily diverts output to a different device.
  - **flush** causes MONITR to discard the messages it collects.
  - **halt** reverses the action of the divert command.
  - **talk** causes MONITR to display its output.
- CONFIG **set logging disposition** command sets the initial device to which MONITR sends its output.

---

### Entering and Exiting MONITR

To enter the MONITR process from OPCODE:

1. At the OPCODE prompt, enter the status command to find the PID (process ID) of MONITR.

```
* status
```

2. Enter the **talk** command and the PID number to enter the MONITR environment.

```
* talk 2
```

MONITR does not display any prompt and you cannot enter any commands; however, the console begins to display the messages MONITR has accumulated.

To exit MONITR and return to OPCODE, enter the OPCODE intercept character (the default is **Ctrl P**).

---

### Receiving MONITR Messages

To receive MONITR messages at your console, contact MONITR as described in the previous section. Then MONITR displays all the messages it has recorded since it was last invoked. While you are connected to MONITR, it displays all messages as they arrive.

You can use the OPCODE **divert** and **halt** commands to view MONITR messages while you are doing something else with the router. Permitted devices divert output to TTY0 (the local console), TTY1, or TTY2 (the remote consoles).



---

## Chapter 11. Using and Configuring the Event Logging System (ELS)

This chapter describes the Event Logging System (ELS) and its configuration. The ELS continually logs all events, filtering them according to parameters that you select. A combination of the GWCON counters and the ELS provides information for monitoring the health and activity of the system. The information is divided into the following sections:

- “What is ELS?”
- “Entering and Exiting the ELS Configuration Environment” on page 11-2
- “Event Logging Concepts” on page 11-3
- “ELS Configuration Commands” on page 11-7

---

### What is ELS?

ELS is a monitoring system and an integral part of the router operating system. ELS manages the messages logged as a result of router activity. Using ELS commands, you can set up a configuration that sorts out only those messages that are important to you. You can display the messages on the console terminal screen or send the messages to a network management station using Simple Network Management Protocol (SNMP) traps.

The ELS system and the GWCON counters are the best troubleshooting tools you have to isolate problems in the router. A quick scan of the event messages will tell you whether or not the router has a problem and basically where to start looking for it.

In the ELS configuration environment, the commands are used to establish a default configuration. This default configuration does not take effect until you reinitialize the router.

Occasionally, it is necessary to temporarily view messages other than what was set up in the ELS configuration environment without having to reinitialize the router. The ELS console environment is used to:

- Temporarily change the default ELS display settings
  - Changes made in the ELS console environment take effect immediately
  - Changes made using console commands are not stored in non-volatile configuration storage.
- View statistical information regarding ELS uses of dynamic RAM

**Note:** Specific ELS messages are described in the *IBM 8210 Multiprotocol Switched Services Server Event Logging System Messages Guide*.

ELS is a subprocess that you access from the OPCON process. ELS fits into the router software structure as shown in Figure 11-1 on page 11-2.

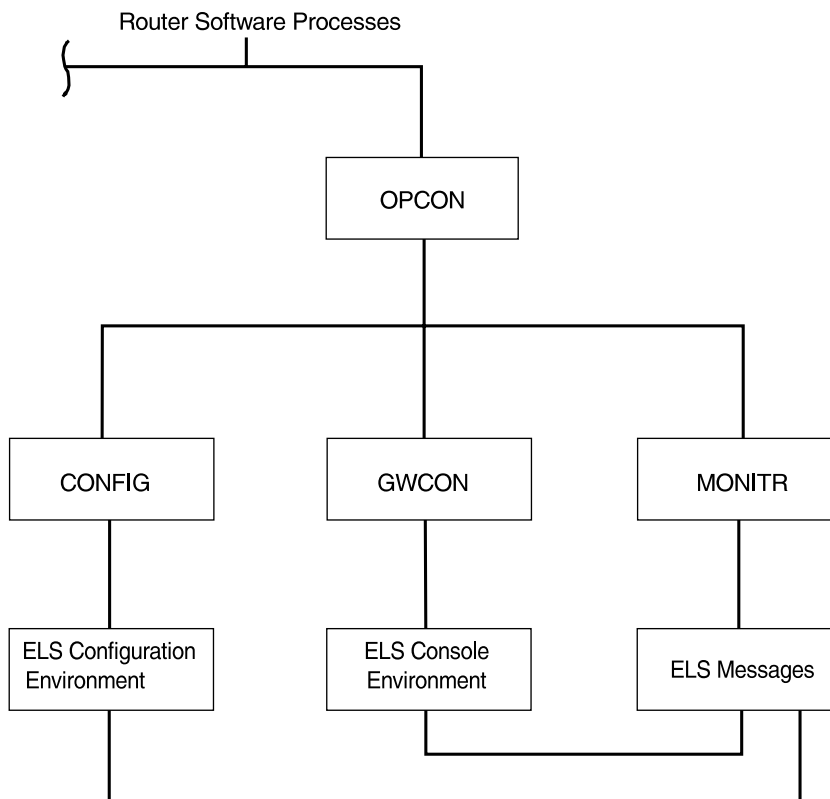

Figure 11-1. ELS in the Router Software Structure

---

## Entering and Exiting the ELS Configuration Environment

The ELS configuration environment (available from the CONFIG process) is characterized by the ELS `Config>` prompt. Commands entered at this prompt create the ELS default state that takes effect after restarting the router. These commands are described in greater detail later in this chapter.

Configuration commands that have subsystem, group, or event as a parameter are executed in the following order:

- Subsystem
- Group
- Event

To set a basic ELS configuration, enter the **display subsystem all standard** command at the ELS `Config>` prompt. This command configures the ELS to display messages from all subsystems with the STANDARD logging level (that is, all errors and unusual informational comments).

**Note:** The router does not have a default ELS configuration. You must enter the ELS configuration environment and set the default state.

This section describes how to enter and exit the ELS configuration and console environments.

## ELS Configuration Environment

To enter the ELS configuration environment from OPCON:

1. At the OPCON prompt, enter the **status** command to find the PID (process ID) of CONFIG.

```
* status
```

2. Enter the **talk** command and the PID for CONFIG.

```
* talk 6
```

The console displays the CONFIG prompt (Config>). If the prompt does not appear when you first enter CONFIG, press **Return**.

3. At the CONFIG prompt, enter the following command to access ELS:

```
Config> eve
```

The console displays the ELS configuration prompt (ELS config>). Now, you can enter ELS configuration commands.

To leave the ELS configuration environment, enter the **exit** command. This command is described in this chapter.

---

## Event Logging Concepts

This section describes how events are logged and how to interpret messages. Also described are the concepts of subsystem, event number, and logging level. A large part of ELS function is based on commands that take the subsystem, event number, and logging level as parameters.

## Causes of Events

Events occur continuously while the router is operating. They can be caused by any of the following reasons:

- System activity
- Status changes
- Service requests
- Data transmission and reception
- Data and internal errors

When an event occurs, ELS receives data from the system that identifies the source and nature of the event. Then ELS generates a message that uses the data received as part of the message.

## Interpreting a Message

This section describes how to interpret a message generated by ELS. Figure 11-2 shows the message contents.

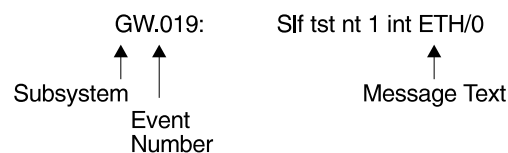

Figure 11-2. Message Generated by an Event

The information illustrated in Figure 11-2 as well as the ELS logging level information displayed with the **list subsystem** command is as follows:

### Subsystem

*Subsystem* is a predefined short name for a router component, such as a protocol or interface. In Figure 11-2 on page 11-3, **GW** identifies the subsystem through which this event occurred.

Other examples of subsystems include IP, TKR, and X25. On a particular router, the actual subsystems present depend on the hardware and software configured for that router. You can use the **list subsystem** command described in this chapter to see a list of the subsystems on your router.

Enter the subsystem as a parameter to an ELS command when you want the command to affect the entire subsystem. For example, the ELS command **display subsystem GW** causes all events that occur through the GW subsystem to be displayed.

### Event Number

*Event Number* is a predefined, unique, arbitrary number assigned to each message within a subsystem. In Figure 11-2 on page 11-3, **19** is the event number within the GW subsystem. You can see a list of all the events within a subsystem by using the **list subsystem** command, where *subsystem* is the short name for the subsystem.

The event number always appears with a subsystem, separated by a period. For example: **GW.019**. The subsystem and event number together identify an *individual* event. They are entered as a parameter to certain ELS commands. When you want a command to affect only the specified event, enter the subsystem and event number as a parameter for the ELS command.

### Logging Level

*Logging level* is a predefined setting that classifies each message by the type of event that generated it. This setting is displayed whenever you use the **list subsystem** ELS console command. Table 11-1 on page 11-5 lists the logging levels and types.

<i>Table 11-1. Logging Levels</i>	
<b>Logging Level</b>	<b>Type</b>
UI ERROR	Unusual internal errors
CI ERROR	Common internal errors
UE ERROR	Unusual external errors
CE ERROR	Common external errors
ERROR	Includes all error levels above
UINFO	Unusual informational comment
CINFO	Common informational comment
INFO	Includes all comment levels above
STANDARD	Includes all error levels and all informational comment levels (default)
PTRACE	Per packet trace
UTRACE	Unusual operation Trace message
CTRACE	Common operation Trace message
TRACE	Includes all trace levels above
ALL	Includes all logging levels

In Table 11-1, ERROR, INFO, TRACE, STANDARD, and ALL are aggregates of other logging level types. STANDARD is the recommended default.

The logging level setting affects the operation of the following commands:

- **Display subsystem**
- **Nodisplay subsystem**
- **Trap subsystem**
- **Notrap subsystem**

The logging level is set for a particular command when you specify it as a parameter to one of the above commands. For example:

```
display subsystem TKR ERROR
```

Including the logging level on the command line modifies the **display** command so that whenever an event with a logging level of either UI-ERROR or CI-ERROR occurs through subsystem TKR, the console displays the resulting message.

You cannot specify the logging level for operations affecting groups or events.

### Message Text

*Message Text* appears in short form. In Figure 11-2 on page 11-3, `S1f tst nt 1 int ETH/0` is the message generated by this event. Variables, such as *source\_address* or *network*, are replaced with actual data when the message displays on the console.

The variable *error\_code* is referred to by some of the Event Logging System message descriptions (usually preceded by *rsn* or *reason*). They indicate the type of packet error detected. Table 11-2 on page 11-6 describes the error or packet completion codes. Packet completion codes indicate the disposition of the packets that arrive at the router.

Code	Meaning
0	Packet successfully queued for output
1	Random, unidentified error
2	Packet not queued for output due to flow control reasons
3	Packet not queued because network is down
4	Packet not queued to avoid looping or bad broadcast
5	Packet not queued because destination host is down (only on networks where this can be detected)

ELS displays network information as follows:

```
nt 1 int Eth/0 (or) network 1, interface Eth/0,
```

where:

- 1 is the network number (each network on the router is numbered sequentially from zero).
- 0 is the unit number (the interfaces of each hardware type are numbered sequentially from zero).

Ethernet and 802.5 hardware addresses appear as a long hexadecimal number.

IP (Internet Protocol) addresses are printed as 4 decimal bytes separated by periods, such as 18.123.0.16.

### Groups

*Groups* are user-defined collections of events that are given a name, the group name. Like the subsystem, subsystem and event number, and logging level, you can use the group name as a parameter to ELS commands. However, there are no predefined group names. You must create a group before you can specify its name on the command line.

To create a group, use the **add** configuration command described in this chapter, specify the name you want to call the group, and then specify the events you want to be part of the group. The events you add to the group can be from different subsystems and have different logging levels.

After creating a group, you can use the group name to manipulate the events in the group as a whole. For example, to turn off display of all messages from events that have been added to a group named `grouptwo`, include the group name on the command line, as follows:

```
nodisplay group grouptwo
```

To delete a group, use the **delete** command.

## ELS Configuration Commands

Table 11-3 summarizes the ELS configuration commands. The remainder of this section describes each one in detail. After accessing the ELS configuration environment, you can enter ELS Configuration commands at the ELS Config> prompt.

Table 11-3. ELS Configuration Command Summary

Command	Function
<b>? (Help)</b>	Lists the ELS configuration commands or lists the options associated with specific commands.
<b>Add</b>	Adds an event to an existing group or creates a new group.
<b>Clear</b>	Clears all ELS configuration information.
<b>Default</b>	Resets the display or trap setting of an event, group, or subsystem.
<b>Delete</b>	Deletes an event number from an existing group or deletes an entire group.
<b>Display</b>	Enables message display on the console monitor.
<b>Exit</b>	Exits the ELS configuration process and returns you to the CONFIG process.
<b>List</b>	Lists information on ELS settings and messages.
<b>Nodisplay</b>	Disables message display on the console.
<b>Notrace</b>	Controls disablement of packet trace events.
<b>Notrap</b>	Keeps messages from being sent out in SNMP traps.
<b>Set</b>	Sets the pin parameter, the timestamp feature, and atm packet tracing options.
<b>Trace</b>	Controls enablement of packet trace events.
<b>Trap</b>	Allows messages to be sent to a network management workstation in SNMP traps.
<b>View</b>	Allows viewing of traced packets.

### ? (Help)

Use the **? (help)** command to list the commands that are available from the current prompt level. You can also enter a **?** after a specific command name to list its options.

**Syntax:** ?

**Example:** ?

```

ADD
CLEAR
DEFAULT
DELETE
DISPLAY
LIST
NODISPLAY
NOTRACE
NOTRAP
SET
TRACE
TRAP
VIEW
EXIT

```

## Configuring ELS

**Example:** `list ?`

```
ALL
GROUPS
PIN
STATUS
SUBSYSTEM
```

## Add

Use the **add** command to add an individual event to an existing group or to create a new group. Group names must start with a letter and are case sensitive. You cannot append an entire subsystem to a group.

**Syntax:** `add group_name subsystem.event_number`

**Example:** `add MyGroup gw.019`

**Note:** If the specified group does not exist, the following prompt asks you to confirm the creation of a new group:

```
Group not found. Create new group? (yes or no)
```

## Clear

Use the **clear** command to clear all of the ELS configuration information.

**Syntax:** `clear`

**Example:** `clear`

```
You are about to clear all ELS configuration information
Are you sure you want to do this (Yes or No):
```

## Default

Resets the display or trap setting of an event, group, or subsystem back to a disabled state.

**Syntax:** `default display`  
`trap`

`display event OR group OR subsystem`

Controls the output of the display of messages to the console.

**Example:** `default display event snmp.016`

`trap event OR group OR subsystem`

Controls the generation of traps to the network management station.

**Example:** `default trap subsystem ip`

## Delete

Use the **delete** command to delete an event number from an existing group or to delete the entire group. If the specified event is the last event to be deleted in a group, you will be notified. If *all* is specified instead of *subsystem.event\_number*, a prompt asks you to confirm the deletion of the entire group.

**Syntax:** `delete group_name subsystem.event_number`

**Example:** `delete groupa gw.019`



## Display

Use the **display** command to enable message displaying on the console monitor for specific events, groups, or subsystems.

**Syntax:** `display`    event . . .  
                                   group . . .  
                                   subsystem . . .

event *subsystem.event#*

Displays messages of the specified event (*subsystem.event#*).

**Example:**    `display event gw.019`

group *groupname*

Displays messages of a specified group (*groupname*).

**Example:**    `display group groupb`

subsystem *subsystemname*

Displays messages associated with the specified subsystem. The following is a list of subsystems that are supported on the router. To find out which subsystems are on your router, type **list subsystems**.

### Notes:

1. See *ELS Messages* for the most current list of supported subsystems.
2. Although ELS supports all of these subsystems, not all devices support all subsystems

### Subsystem    Description

AI                Auto-device Install  
 All               All subsystems

**Note:** Do not display all subsystems for extended periods of time when the router is forwarding live protocol traffic because this causes the router to spend an excessive amount of time communicating with the console. Never display all subsystems when you are communicating with the router via a remote console. This causes the router to spend most of its time communicating with the remote console.

AP2	AppleTalk Phase 2
ARP	Address Resolution Protocol
APPN	Advanced Peer-to-Peer Networking
ATM	Asynchronous Transfer Mode
BAN	Boundary Access Node
BGP	Border Gateway Protocol
BR	Bridging/Routing
BRS	Bandwidth Reservation
BTP	BOOTP relay agent
CLNP	ISO 8473 - CLNP
COMP	Data Compression
DLS	Data Link Switching
DN	DECnet
DNAV	DNA Phase V
DVM	DVMRP Multicast Routing Protocol
ESIS	ISO 9542 - ESIS Protocol
ETH	Ethernet handler

## Configuring ELS

EZ	EasyStart
FLT	Filter library
FRL	Frame Relay
GW	Router base and network library
ICMP	Internet Control Message Protocol
ILMI	Interim Local Management Interface
IP	Internet Protocol
IPPN	IP Protocol Net
IPX	Internetwork Packet Exchange Protocol
ISDN	Integrated-services Digital Network
ISIS	ISO 10589 - ISIS Protocol
LEC	LAN Emulation Client
LECS	LAN Emulation Configuration Server
LES	LAN Emulation Server
LLC	Logical Link Control
LNM	LAN Network Manager
MCF	MAC Filtering
MSPF	OSPF Multicast extensions
NBS	NetBIOS Support Subsystem
NOT	Non-supported Protocol Forwarder
OSPF	Open SPF-based Routing Protocol
PPP	Point-to-Point Protocol
RIP	IP Routing Information Protocol
R2MP	AppleTalk Phase 2 Routing Table Management Protocol
SAAL	Signaling ATM Adaptation Layer
SDLC	IBM SDLC
SL	Serial Line Handler
SNMP	Simple Network Management Protocol
SRLY	SDLC Relay
SRT	Source Routing Transparent Bridge
STP	Spanning Tree Protocol
SVC	Switched Virtual Connection
TCP	Transport Control Protocol
TFTP	Trivial File Transfer Protocol
TKR	Token Ring Handler
UDP	User Datagram Protocol
VIN	Banyan VINES
V25B	CCITT/ITU V.25 bis
WRS	WAN Restoral/Reroute
XN	XNS/IPX/DDS common processing
XNS	Xerox Networking Systems Protocol
X25	X.25 Protocols
X251	X.25 Physical Layer
X252	X.25 Frame Layer
X253	X.25 Packet Layer
XTP	X.25 Transport Protocol
ZIP2	AppleTalk Phase 2 Zone Information Protocol
ILMI	ATM Interim Local Management Interface
LEC	ATM LAN Emulation Client

**Example:** `display subsystem tkr`

## List

Use the **list** command to get updated information regarding ELS settings and listings of selected messages.

**Syntax:** `list`     all  
                           groups  
                           pin  
                           status  
                           subsystem  
                           subsystem . . .  
                           subsystems all  
                           trace-status

all

Lists information from all the **list** categories.

**Example:**    `list all`

groups

Lists the user-defined group names and contents.

**Example:**    `list groups`

```
Group: test
GW.019
```

pin

Lists the current number of ELS event messages sent in SNMP traps (per second).

**Example:**    `list pin`

```
Pin: 100 events/second
```

status

Lists the subsystems, groups, and events that have been modified by the **display**, **nodisplay**, **trap**, and **notrap** commands.

**Example:**    `list status`

subsystem

Lists names, events, and descriptions of all subsystems.

**Example:**    `list subsystem`

(Example output from a **list subsystem** command can be found beginning on page 12-9.)

subsystem *subsystem*

Lists all events in a specified subsystem.

**Example:**    `list subsystem gw`

## Configuring ELS

Event	Level	Message
GW.001	ALWAYS	Copyright 1984 Mass Institute of Technology
GW.002	ALWAYS	Portable CGW %s Rel %s strt'd
GW.003	ALWAYS	Unus pkt len %d nt %d int %s/%d
GW.004	ALWAYS	Sys %s q adv alloc %d excd %d
GW.005	ALWAYS	Bffrs: %d avail %d idle fair %d low %d
GW.006	C-INFO	Pkt frm nt %d int %s/%d for uninit prt, disc
GW.007	C-INFO	Ip err %x nt %d int %s/%d
GW.008	U-INFO	Ip ovfl nt %d int %s/%d, disc
GW.009	UI-ERROR	Nt dwn ip rstrt nt %d int %s/%d
GW.010	UI-ERROR	Ip q len %d no ip buf nt %d int %s/%d
GW.011	U-INFO	Op err %x hst %wo nt %d int %s/%d
GW.012	U-INFO	Op err cnt excd hst %wo nt %d int %s/%d
GW.013	U-INFO	Rtrns cnt excd hst %wo nt %d int %s/%d
GW.014	UI-ERROR	Nt dwn op rstrt nt %d int %s/%d
GW.015	UI-ERROR	Nt dwn to hst %wo nt %d int %s/%d
GW.016	U-INFO	Op ovfl to hst %wo nt %d int %s/%d
GW.017	UE-ERROR	Intfc hdw mssng nt %d int %s/%d
GW.018	U-TRACE	Strt nt slf tst nt %d int %s/%d
GW.019	C-INFO	Slf tst nt %d int %s/%d
GW.020	U-TRACE	Nt pss slf tst nt %d int %s/%d
GW.021	UE-ERROR	Nt up nt %d int %s/%d
GW.022	U-TRACE	Nt fld slf tst nt %d int %s/%d

### subsystems all

Lists all events in all subsystems.

**Example:** `list subsystems all`

### trace-status

Displays information on the status of packet tracing, including configuration and run-time information.

**Example:** `list trace-status`

```
----- Configuration -----  
Trace Status:ON Wrap Mode:ON Decode Packets:OFF HD Shadowing:OFF  
RAM Trace Buffer Size:100000 Maximum Trace Buffer File Size:10000000  
Default Packet Bytes Traced:100 Max Packet Bytes Traced:256  
----- Run-time Status -----  
Packets in RAM Trace Buffer:535 Free Trace Buffer Memory:180  
Trace Errors:22 First Packet:23 Last Packet:557  
Trace Buffers Shadowed to HD:0 Trace Buffer File Size:0
```

## Nodisplay

Use the **nodisplay** command to select and turn off messages displaying on the console monitor.

**Syntax:** `nodisplay event . . .  
group . . .  
subsystem . . .`

`event subsystem.event#`

Suppresses the displaying of a specified event (*subsystem.event#*).

**Example:** `nodisplay event gw.019`

`group groupname`

Suppresses the displaying of messages that were previously added to the specified group (*groupname*).

**Example:** `nodisplay group groupb`

subsystem *subsystemname*

Suppresses the displaying of messages associated with the specified subsystem.

**Example:** `nodisplay subsystem tkr`

## Notrace

Disables packet trace for the specified event/subsystem/group.

**Syntax:** `notrace event. . .`  
`group. . .`  
`subsystem. . .`

event subsystem.*event#*

Suppresses the sending of packet trace data for the specified event#

**Example:** `notrace event atm.088`

group *groupname*

Suppresses the sending of packet trace data that was previously added to the specified group (*groupname*).

**Example:** `notrace group groupb`

subsystem *subsystemname*

Suppresses the sending of packet trace data for the specified subsystem (*subsystemname*).

**Example:** `notrace subsystem atm`

## Notrap

Use the **notrap** command to select and turn off messages so that they are no longer sent to a network management workstation in SNMP traps.

**Syntax:** `notrap event. . .`  
`group . . .`  
`subsystem . . .`

event *subsystem.event#*

Suppresses the sending of the specified message in an SNMP trap (*subsystem.event#*).

**Example:** `notrap event gw.019`

group *groupname*

Suppresses the sending of messages in SNMP traps that were previously added to the specified group (*groupname*).

**Example:** `notrap group groupb`

subsystem *subsystemname*

Suppresses the sending of messages in SNMP traps that are associated with the specified subsystem.

**Example:** `notrap subsystem tkr error`

### Set

Use the **set** command to set the maximum number of traps per second, to set the timestamp feature, or to set tracing options for ATM devices.

**Syntax:** `set pin . . .`  
`timestamp . . .`  
`trace . . .`

#### `pin max_traps`

Use the **set pin** command to set the pin parameter to the maximum number of traps that can be sent on a per-second basis. Internally, the pin resets every tenth of a second. (One tenth of the number (*max\_traps*) is sent every tenth of a second.)

**Example:** `set pin 100`

#### `timestamp timeofday OR uptime OR off`

Allows you to turn on message timestamping so that either the time of day or uptime (number of hours, minutes, and seconds, but no date, since the router was last initialized) appears next to each message. Set timestamp can also be turned off.

Use the **set timestamp** command to enable one of the following timestamp options.

**Example:** `set timestamp timeofday`

#### *timeofday*

Adds an HH:MM:SS prefix to each ELS message indicating the time of the occurrence during a 24-hour day.

#### *uptime*

Adds an HH:MM:SS prefix to each ELS message indicating the time of the occurrence during a 100-hour cycle. After 100 hours of uptime, the uptime counter returns to zero to begin another 100-hour cycle.

#### *off*

Turns off the ELS timestamp prefix.

#### `trace`

Use the **set trace** command to configure tracing options for ATM devices. When tracing options are configured from the monitoring console, the changes take effect immediately, and return to their previously configured settings when the device is rebooted.

**Syntax:** `set trace`            `decode`  
                                 `default-bytes-per-port`  
                                 `disk-shadowing`  
                                 `max-bytes-per-port`  
                                 `memory-trace-buffer-size`  
                                 `off`  
                                 `on`  
                                 `reset`  
                                 `wrap-mode`

#### `decode off/on`

Turns packet decoding on or off. Packet decoding is not supported by all components.

default-bytes-per-pkt *bytes*

Sets the default number of bytes traced. This value is used if a value is not specified by the component doing the tracing.

disk-shadowing *off/on*

Turns disk shadowing on or off and sets the maximum trace file size. If disk shadowing is enabled, trace records are copied to the hard disk. Once a traced record is copied to the hard disk, it is no longer viewable through the console.

max-bytes-per-pkt *bytes*

Sets the maximum number of bytes traced for each packet.

memory-trace-buffer-size *bytes*

Sets the size, in bytes, of the RAM trace buffer.

off

Disables packet tracing.

on

Enables packet tracing.

reset

Clears the trace buffer and resets all associated counters.

wrap-mode *off/on*

Turns the trace buffer wrap mode on or off. If wrap mode is on and the trace buffer is full, previous trace records will be overwritten by new trace records as necessary to continue tracing.

**Example 1:**    **set trace decode on**

**Example 2:**    **set trace default-bytes-per-packet 64**

**Example 3:**    **set trace off**

## Trace

Enables packet trace for the specified event/subsystem/group. When the **trace** command is used from the `ELS Config>` prompt, the changes become part of the configuration, and a reboot is required to activate the changes.

See “Trace” on page 12-14 for a complete description of the **trace** command.

## Trap

Use the **trap** command to select the message to be sent to the remote SNMP network management workstation. A remote SNMP network management workstation is an IP host in the network acting as an SNMP manager.

**Syntax:** trap    event . . .  
                  group . . .  
                  subsystem . . .

event *subsystem.event#*

Causes the specified message (*subsystem.event#*) to be sent to a network management workstation in an SNMP trap.

**Example:**    **trap event gw.019**

## Configuring ELS

`group groupname`

Allows messages that were previously added to the specified group to be sent to a network management workstation in an SNMP trap.

**Example:** `trap group groupb`

`subsystem subsystemname`

Allows messages associated with the specified subsystem to be sent to a management station in an SNMP trap.

**Example:** `trap subsystem gw`

**Note:** Messages for the IP, ICMP, ARP and UDP subsystems cannot be sent in SNMP traps because these areas are or may be used in the process of sending the SNMP trap. This could lead to an infinite loop of traffic putting an undue strain on the router.

## Exit

Use the **exit** command to return to the CONFIG prompt.

**Syntax:** `exit`

**Example:** `exit`



## Chapter 12. Monitoring the Event Logging System (ELS)

This chapter describes how to monitor events logged by ELS and how to use the ELS console commands. The information includes the following sections:

- “Using ELS”
- “Using ELS to Troubleshoot a Problem” on page 12-3
- “Entering and Exiting the ELS Console Environment” on page 12-5
- “ELS Console Commands” on page 12-6

If you need more information on the Event Logging System and how to interpret ELS event messages, refer to Chapter 11, “Using and Configuring the Event Logging System (ELS).”

### Using ELS

To effectively use ELS, it is recommended you do the following:

- Know what you want to see before using the ELS system. Clearly define the problem or events that you want to see before using the MONITR process.
- Execute the command **nodisplay subsystem all all** to turn off all ELS messages.
- Turn on only those messages that relate to the problem you are experiencing.
- Use the *IBM 8210 Multiprotocol Switched Services Server Event Logging System Messages Guide* to determine which messages you are seeing are normal.

When you initially view ELS from the MONITR process, you will see a considerable amount of information. Because the router cannot buffer and display every packet under moderate to heavy loads the buffers are flushed. When this occurs the following message is displayed:

```
xx messages flushed
```

The router does not save these messages so that they can be reviewed later. When this message appears, you may want to tailor the ELS output to display only that information that is important to the current task you are monitoring.

### Managing ELS Message Rotation

It is also important to note that the ELS messages continually rotate through the router's buffers. To stop and restart the displaying of ELS messages, use the following key combinations:

<b>Ctrl</b>	<b>S</b>	to pause scrolling
<b>Ctrl</b>	<b>Q</b>	to resume scrolling
<b>Ctrl</b>	<b>P</b>	to go back to the last process

You may also want to capture the ELS output to a file. You can do this by starting a script file or log file from your location when Telneting to a router. You can also do this by attaching a PC to the router's console port and starting a log file from within the terminal emulation package. This information is needed to help Customer Service diagnose a problem.

### Capturing ELS Output Using a Telnet Connection on a UNIX Host

You can use a Telnet connection on an AIX or UNIX host to capture the ELS messages on your screen to a file on the host. Before beginning, make sure you have set up ELS for the messages you want to capture by using the ELS console commands in this chapter.

To capture the ELS output to a file on an AIX or UNIX host, follow these steps:

1. From the host, enter **telnet router\_ip\_addr | tee local\_file\_name**

*router\_ip\_addr* is the IP address of the router

*local\_file\_name* is the name of the file on the host where you want the ELS messages to be saved.

The **tee** command displays the ELS messages on your screen and, at the same time, copies them to the local file.

2. From the OPCON prompt (\*), enter **t 2**. This accesses the MONITR process, which is the process that displays ELS messages on your screen. Depending on which ELS messages you configured, you should see ELS messages appearing on the screen.

As long as you are in the MONITR process, all ELS messages will be written to the local file. When you exit the MONITR process (by entering **Ctrl P**) or terminate the Telnet session, the logging of messages to the local file will stop.

### Configuring ELS So Event Messages Are Sent In SNMP Traps

ELS can be configured so that event messages are sent to a network management workstation in an SNMP enterprise-specific trap. These traps are useful for reporting status and diagnostic results, and are often used for remote monitoring of a IBM 8210. When ELS is configured appropriately, an SNMP trap will be generated each time the selected event occurs. For more information about SNMP, see *Multiprotocol Switched Services (MSS) Server Command Line Interface Volume 2*.

To tell ELS that a specific event should be activated to be sent as an SNMP trap, at the ELS `config>` prompt or at the `ELS>` prompt, using IP as an example, type:

```
trap event ip.007
```

**Note:** If you are at the ELS `config>` prompt, you will need to reboot.

To enable the ELS enterprise-specific trap, follow these steps:

1. At the SNMP `config>` prompt, using **public** as an example, type:

```
SNMP config> add address public <network manager IP address>
```

```
SNMP config> enable trap enterprise public
```

```
SNMP config> set community access read_trap public
```

**Note:** You will need to reboot to activate these changes.

2. Enable your network management station to receive and properly display the enterprise-specific traps.

You can follow the steps above for trapping groups, subsystems, and events.

---

## Using ELS to Troubleshoot a Problem

Events occur continuously while the router is operating. They can be caused by any of the following reasons:

- System activity
- Status changes
- Service requests
- Data transmission and reception
- Data and internal errors

When an event occurs, ELS receives data from the system that identifies the source and nature of the event. Then ELS generates a message that uses the data received as part of the message.

When trying to troubleshoot a particular problem, display those messages that relate to the problem. For example, if you are experiencing a problem with bridging, turn on the bridging messages:

```
display subsystem srt all  
display subsystem br all
```

Initially, because of the rapid pace of messages scrolling across the screen, you may want to record the numbers you see and look those up in the manual. Once you become familiar with different types of messages being displayed for a particular protocol, you can turn on and turn off only those messages that contain the information that you require to troubleshoot a problem. The following sections list specific ELS examples. Keep in mind that different problems may require different steps.

### ELS Example 1

You are interested in looking at the frequency of polling on a Token-Ring interface, and finding out whether the polls are successful.

```
ELS> nodisplay subsystem all all
```

```
ELS> display subsystem tkr all
```

```
Ctrl P
```

```
* t 2
```

As the messages begin to scroll by, look for ELS message tkr.031.

### ELS Example 2

SRTB bridging is not working.

1. Check the configuration.
2. Use the GWCON bridging console to verify that the bridging interfaces are enabled.

## Using ELS in Monitoring

### 3. Enter:

```
* t 6  
  
config> event  
  
ELS config> nodisplay subsystem all all  
  
ELS config> display subsystem srt all  
  
ELS config> exit  
  
config> Ctrl P
```

### 4. Restart the routing subsystem. When the subsystem has restarted, enter the following:

```
* t 2
```

As the messages begin to scroll by, look for messages srt.071 through srt.075. If you see one of these messages, you are not licensed to use one or more of the bridging features.

## ELS Example 3

Router cannot communicate with an IPX server on an Ethernet.

### 1. At the OPCODE prompt, enter the **status** command to find the PID (process ID) of GWCON. (See step 1 on page 11-3 in ELS Configuration Environment for a sample output of the **status** command.)

```
* status
```

### 2. Enter the **talk** command and the PID for GWCON.

```
* talk 5
```

The console displays the GWCON prompt (+). If the prompt does not appear when you first enter GWCON, press **Return**.

### 3. At the GWCON prompt (+), enter **IPX** to access the IPX console prompt (IPX>).

### 4. At the IPX console prompt, enter the **slist** command to verify that the server is listed. (See the section on monitoring IPX in the *Multiprotocol Switched Services (MSS) Server Command Line Interface Volume 2* for information on the slist command.)

### 5. Check the IPX configuration.

### 6. Enter the following:

```
* t 5  
  
+ event  
  
ELS> nodisplay subsystem all all  
  
ELS> display subsystem IPX all  
  
ELS> display subsystem eth all  
  
ELS> Ctrl P  
  
* t 2
```

As the messages begin to scroll by, look for ELS message eth.006. This indicates that the server has a bad econfig.

---

## Entering and Exiting the ELS Console Environment

The ELS console environment (available from the GWCON process) is characterized by the ELS> prompt. Commands entered at this prompt modify the current ELS parameter settings. These commands are described Chapter 12, “Monitoring the Event Logging System (ELS).”

To enter the ELS console environment from OPCON:

1. At the OPCON prompt, enter the **status** command to find the PID (process ID) of GWCON. (See step 1 on page 11-3 in ELS Configuration Environment for a sample output of the **status** command.)

\* **status**

2. Enter the **talk** command and the PID for GWCON.

\* **talk 5**

The console displays the GWCON prompt (+). If the prompt does not appear when you first enter GWCON, press **Return**.

3. At the GWCON prompt, enter the following command to access ELS:

+ **event**

The console displays the ELS console prompt (ELS>). Now, you can enter ELS console commands.

To leave the ELS console environment, enter the **exit** command. This command is described in this chapter.

## ELS Console Commands

This section summarizes and then explains all the ELS console commands. After accessing the ELS Console environment, you can enter ELS console commands at the ELS> prompt.

*Table 12-1. ELS Console Command Summary*

Command	Function
<b>? (Help)</b>	Lists the ELS console commands or lists the options associated with specific commands.
<b>Clear</b>	Clears messages associated with specific events, groups, or subsystems.
<b>Display</b>	Enables message display on the console.
<b>Exit</b>	Exits the ELS console process and returns the user to GWCON.
<b>List</b>	Lists information on ELS settings and messages.
<b>Nodisplay</b>	Disables message display on the console.
<b>Notrace</b>	Disables trace event display on the console.
<b>Notrap</b>	Keeps messages from being sent out in SNMP traps to the network management workstation.
<b>Remove</b>	Frees up memory by erasing stored information.
<b>Restore</b>	Clears current settings and reloads initial ELS configuration.
<b>Retrieve</b>	Reloads the saved ELS configuration.
<b>Save</b>	Stores the current configuration.
<b>Set</b>	Sets the pin parameter and the timestamp feature. *
<b>Statistics</b>	Displays available subsystems and pertinent statistics.
<b>Trace</b>	Enables trace event display on the console.
<b>Trap</b>	Allows messages to be sent to a network management workstation in SNMP traps.
<b>View</b>	Allows viewing of traced packets.

### ? (Help)

Use the **? (help)** command to list the commands that are available from the current prompt level. You can also enter a **?** after a specific command name to list its options.

**Syntax:**     ?

**Example: ?**

```

CLEAR
DISPLAY
LIST
NODISPLAY
NOTRACE
NOTRAP
REMOVE saved state
RESTORE initial state
RETRIEVE saved state
SAVE current state
SET
STATISTICS
TRACE
TRAP
VIEW
EXIT

```

**Example: list ?**

```

ALL
ACTIVE
EVENT
GROUPS
PIN
SUBSYSTEMS
TRACE

```

## Clear

Use the clear command to disable both the display and trap commands as they relate to specific events, groups, or subsystems.

**Syntax:** `clear` event . . .  
group . . .  
subsystem . . .

`event` *subsystem.event#*

Disables the displaying or trapping of messages for the specified event (*subsystem.event#*).

**Example:** `clear event gw.019`

`group` *group.name*

Disables the displaying or trapping of messages for the specified group (*group.name*). specified group (*groupname*).

**Example:** `clear group groupb`

`subsystem` *subsystem.name*

Disables the displaying or trapping of messages associated with the specified subsystem (*logging level*). If you do not specify a logging level, all messages for that subsystem are disabled.

**Example:** `clear subsystem gw`

## Display

Use the display command to enable the message display on the console monitor for specific events.

**Syntax:** `display` event . . .  
group . . .  
subsystem . . .

## Monitoring ELS

event *subsystem.event#*

Displays messages for the specified event (*subsystem.event#*).

**Example:** `display event gw.019`

group *group.name*

Displays the messages that were previously added to the specified group (*group.name*).

**Example:** `display group groupb`

subsystem *subsystem.name*

Displays any messages associated with the specified subsystem (*logging level*). If you do not specify a logging level, all messages for that subsystem are turned on.

**Example:** `display subsystem tkr`

## Files

Use the **files** command to transfer trace files to another host on the network using TFTP.

**Syntax:** `files trace tftp host_IP_addr filename`

*host\_IP\_addr*

Is the IP address of the host to which you are transferring the files.

*filename*

Is the target file name. For TFTP, the file name must be fully path specified, and the file name must already exist on the target host.

**Example:** `files trace tftp 9.67.240.163 trace1.log`

## List

Use the list command to get updated information regarding ELS settings and to get listings of selected messages.

**Syntax:** `list`      all  
                         active . . .  
                         event . . .  
                         groups . . .  
                         pin  
                         subsystems . . .  
                         trace-status

`all`

Lists all subsystems, defined groups, enabled subsystems, enabled events, and pins.

**Example:** `list all`

`active` *subsystem.name*

Displays the events that are active for a specific subsystem and the count of the occurrence of the messages.

**Example:** `list active ip`

```
EventActiveCount
IP.00789354
ETH.009D10
Subsystem X25: no event active
```



event *subsystem.event#*

Displays the logging level, the message, and the count of the specified event.

**Example:** `list event ip.007`

```
Level: p-TRACE
Message: %I -> %I
Active: Count: 84182
```

groups *group.name*

Displays the user-defined group names.

**Example:** `list groups`

pin

Lists the current number of ELS event messages sent per second in SNMP traps. This is a threshold value that can be used to reduce the amount of SNMP trap traffic.

**Example:** `list pin`

```
Pin: 100 events/second
```

subsystem *subsystem.name*

Lists event names, the total number of events that have occurred, and their descriptions.

**Note:** The following example represents a list subsystem command and may not reflect all of the subsystems and their event numbers. For the most recent list of subsystems and event numbers, see *ELS Messages*.

**Example:** `list subsystem`

Name	Events	Description
ALL		All subsystems
APPN	28	Advanced Peer-to-Peer Networking
GW	78	Router base and network library
FLT	7	Filter Library
BRS	4	Bandwidth Reservation
ARP	19	Address Resolution Protocol
IP	86	Internet Protocol
ICMP	20	Internet Control Message Protocol
TCP	55	TCP
UDP	4	User Datagram Protocol
BTP	5	BOOTP relay agent
RIP	19	IP Routing Information Protocol
OSPF	61	Open SPF-Based Routing Protocol
MSPF	15	OSPF Multicast extensions
TFTP	24	TFTP Protocol
SNMP	20	Simple Network Management Protocol
DVM	21	DVMRP Multicast Routing Protocol
IPX	89	Internetwork Packet Exchange Protocol
SRT	87	Source Routing Transparent Bridge
STP	32	Spanning Tree Protocol
BR	29	Bridge/Routing
SRLY	28	SDLC Relay
ETH	47	Ethernet Handler
TKR	45	Token Ring Handler
X25	53	X.25 Protocols
ILMI	6	Interim Local Management Interface
LECS	9	LAN Emulation Configuration Server
LES	8	LAN Emulation Server
X251	16	X.25-Physical-Layer
X252	34	X.25-Frame-Layer
X253	39	X.25-Packet-Layer
XTP	57	X.25 Transport Protocol
IPPN	4	IP Protocol Net
WRS	22	WAN Restoral/Reroute
LLC	33	Logical Link Control

## Monitoring ELS

MCF	9	MAC Filtering
SAAL	18	Signaling ATM Adaptation Layer
V25B	28	CCITT/ITU V.25bis
ATM	13	Asynchronous Transfer Mode
LEC	7	ATM LAN Emulation Client
SVC	5	ATM Signalling

subsystem *subsystem.name*

Lists all events, logging levels, and messages for the specified subsystem.

**Example:** `list subsystem eth`

Event	Level	Message
ETH.001	P-TRACE	brd rcv unkwn type %X %E -> %E nt %d int %s/%d
ETH.002	UE-ERROR	rcv unkwn typ %X %E -> %E nt %d int %s/%d
ETH.010	C-INFO	LLC unk SAP %X %E -> %E nt %d int %s/%d

subsystems all

Lists all events, logging levels, and messages for every event that has occurred on the router.

**Example:** `list subsystems all`

trace-status

Displays information on the status of ATM packet tracing, including configuration and run-time information.

**Example:** `list trace-status`

```
----- Configuration -----  
Trace Status:ON Wrap Mode:ON Decode Packets:OFF HD Shadowing:OFF  
RAM Trace Buffer Size:100000 Maximum Trace Buffer File Size:10000000  
Default Packet Bytes Traced:100 Max Packet Bytes Traced:256  
----- Run-time Status -----  
Packets in RAM Trace Buffer:535 Free Trace Buffer Memory:180  
Trace Errors:22 First Packet:23 Last Packet:557  
Trace Buffers Shadowed to HD:0 Trace Buffer File Size:0
```

## Nodisplay

Use the **nodisplay** command to select and turn off messages displaying on the console monitor.

**Syntax:** `nodisplay event . . .  
          group . . .  
          subsystem . . .`

event *subsystem.event#*

Suppresses the displaying of messages for the specified event.

**Example:** `nodisplay event gw.019`

group *group.name*

Suppresses the displaying of messages that were previously added to the specified group (*group.name*).

**Example:** `nodisplay group groupb`

subsystem *subsystem.name*

Suppresses the displaying of messages associated with the specified subsystem (*logging level*).

**Example:** `nodisplay subsystem tkr`

## Notrace

Use the **notrace** command to stop display of selected trace events at the console.

**Syntax:** `notrace` event. . .  
                   group . . .  
                   subsystem . . .

`event` *subsystem.event#*

Suppresses the display of the specified tracing event. (*subsystem.event#*).

**Example:**   **notrace event gw.019**

`group` *groupname*

Suppresses the display of tracing events related to the specified group (*groupname*).

**Example:**   **notrace group groupb**

`subsystem` *subsystemname*

Suppresses the display of tracing events that are associated with the specified subsystem.

**Example:**   **notrace subsystem atm error**  
                   **notrace subsystem atm**

## Notrap

See “Notrap” on page 11-13 for an explanation of the **Notrap** command.

## Remove

Use the **remove** command to free up memory by erasing stored information. If you have previously saved the current configuration with the **save** command, **remove** allows you to erase the saved configuration.

**Syntax:** `remove`

**Example:**   **remove**

## Restore

Use the **restore** command to clear all current settings (except counters) and reload the initial ELS configuration. To retain the current settings, use the **save** command before restoring the initial configuration.

**Syntax:** `restore`

**Example:**   **restore**

## Retrieve

Use the **retrieve** command to reload the saved ELS configuration. If you have previously saved the current configuration with the **save** command, use **retrieve** to reload it. **Retrieve** does not erase the saved configuration after it executes. To erase the saved configuration, use the **remove** command.

**Syntax:** `retrieve`

**Example:**   **retrieve**

### Save

Use the **save** command to store the current configuration (except counters). **Save** does not affect the default configuration (the one you set with the configuration commands). Use **save** after modifying the configuration with the console commands with the intention of saving this configuration over a restart. There can be only one saved configuration at a time. To reload the saved configuration, use the **retrieve** command.

**Syntax:** `save`

**Example:** `save`

### Set

Use the **set** command to set the maximum number of traps per second, to set the timestamp feature, or to set the tracing options.

*pin*

Use the **set pin** command to set the pin parameter to the maximum number of traps that can be sent on a per-second basis. Internally, the pin resets every tenth of a second. (One tenth of the number *max\_traps* is sent every tenth of a second.)

**Syntax:** `set pin max_traps`

**Example:** `set pin 100`

*timestamp*

Allows you to turn on message timestamping so that either the time of day or uptime (number of hours, minutes, and seconds, but no date, since the router was last initialized) appears next to each message, or to turn off message timestamping.

**Note:** If you turn on timestamping, you must remember to go back into the CONFIG process and set the router's date and time using the time command. Otherwise, all messages will come out with 00:00:00, or negative numbers in the hours, minutes, and/or seconds, for example 00:-4:-5.

Use the **set timestamp** command to enable one of the following timestamp options:

*timeofday* Adds an HH:MM:SS prefix to each ELS message indicating the time of the occurrence during a 24-hour day.

*uptime* Adds an HH:MM:SS prefix to each ELS message indicating the time of the occurrence during a 100-hour cycle of uptime for the router. After 100 hours of uptime, the uptime counter returns to zero to begin another 100-hour cycle.

*off* Turns off the ELS timestamp prefix.

**Syntax:** `set timestamp timeofday OR uptime OR off`

**Example:** `set timestamp timeofday`

*trace*

Use the **set trace** command to configure tracing options. When tracing options are configured from the monitoring console, the changes take effect immediately, and return to their previously configured settings when the device is rebooted.

**Syntax:** `set trace decode . . .`

default-bytes-per-port . . .  
 disk-shadowing . . .  
 max-bytes-per-port . . .  
 memory-trace-buffer-size . . .  
 off  
 on  
 reset  
 wrap-mode . . .

*decode off / on*

Turns packet decoding on or off. Packet decoding is not supported by all components.

*default-bytes-per-pkt bytes*

Sets the default number of bytes traced. This value is used if a value is not specified by the component doing the tracing.

*disk-shadowing off / on*

Turns disk shadowing on or off and sets the maximum trace file size. If disk shadowing is enabled, trace records are copied to the hard disk. Once a traced record is copied to the hard disk, it is no longer viewable through the console.

*max-bytes-per-pkt bytes*

Sets the maximum number of bytes traced for each packet.

*memory-trace-buffer-size bytes*

Sets the size, in bytes, of the RAM trace buffer.

*off*

Disables packet tracing.

*on*

Enables packet tracing.

*reset*

Clears the trace buffer and resets all associated counters.

*wrap-mode off/on*

Turns the trace buffer wrap mode on or off. When wrap mode is enabled and the trace buffer is full, previous trace records will be overwritten by new trace records as necessary to continue tracing.

**Example 1:** `set trace decode on`

**Example 2:** `set trace default-bytes-per-packet 64`

**Example 3:** `set trace off`

## Statistics

Use the **statistics** command to display a list of all of the available subsystems and their statistics.

**Note:** The following example may not match your display exactly. The output of the command depends on the version and release of the installed software.

**Syntax:** `statistics`

**Example: statistics**

Subsys	Vector	Exist	String	Active	Heap
GW	80	78	2376	3	36
FLT	20	7	184	0	0
BRS	50	4	161	0	0
ARP	25	19	567	0	0
IP	100	86	2230	0	0
ICMP	30	20	506	0	0
TCP	60	55	2353	0	0
UDP	10	4	109	0	0
BTP	10	5	137	0	0
RIP	30	19	395	0	0
OSPF	80	61	2339	0	0
MSPF	40	15	514	0	0
TFTP	25	24	592	0	0
SNMP	30	20	580	0	0
DVM	30	21	589	0	0
IPX	100	89	3771	0	0
AP2	80	68	1733	0	0
ZIP2	60	51	1859	0	0
R2MP	50	38	1233	0	0
VIN	90	79	3205	0	0
SRT	120	87	4663	0	0
STP	60	32	1590	0	0
BR	50	29	1583	0	0
SRLY	30	28	1448	0	0
ETH	60	47	1098	0	0
TKR	60	45	2031	0	0
X25	70	53	1893	0	0
SDLC	100	92	4105	0	0
FRL	52	52	3127	0	0
PPP	120	93	2939	0	0
X251	50	16	544	0	0
X252	50	34	996	0	0
X253	50	39	1420	0	0
IPPN	20	4	132	0	0
WRS	40	22	1340	0	0
LLC	60	33	1522	0	0
MCF	15	9	239	0	0
V25B	30	28	1058	0	0
Total	2907	2237	83599	3	36

Maximum: 3493 vector, 110 subsystem  
 Memory: 31437/440 vector + 37164/84816 data + 36 heap = 153893

<i>Subsys</i>	Name of subsystem
<i>Vector</i>	Maximum size of subsystem
<i>Exist</i>	Number of events defined in this subsystem
<i>String</i>	Number of bytes used for message storage in this subsystem
<i>Active</i>	Number of active (displayed, trapped, or counted) events in the subsystem
<i>Heap</i>	Dynamic memory in use by subsystem

## Trace

Use the **trace** command to select the trace events to be displayed on the system console.

**Syntax:** `trace` event . . .  
`fi` group . . .  
`fi` subsystem . . .

event *subsystem.event#*

Causes the specified trace event (*subsystem.event#*) to be displayed on the system console.

**Example:** `trace event gw.019`

group *groupname*

Allows trace events that were previously added to the specified group to be displayed on the router console.

**Example:** `trace group groupb`

subsystem *subsystemname*

Allows trace events associated with the specified subsystem to be displayed on the router console.

**Example:** `trace subsystem gw`

## Trap

See “Trap” on page 11-15 for an explanation of the **Trap** command.

## View

Use the **view** command to view traced packets.

**Syntax:** `view` current  
                   first  
                   jump  
                   last  
                   next  
                   prev  
                   search ...

**current**

Displays the current trace packet. If the current packet is not valid, the first packet in the trace buffer is displayed.

**first**

Displays the first traced packet in the trace buffer.

**jump *n***

Displays the traced packet *n* packets ahead of or behind the current packet.

**last**

Displays the last traced packet in the trace buffer.

**next**

Displays the next traced packet.

**prev**

Displays the previous traced packet.

**search *hexstring***

Displays the next traced packet that contains the specified hex string.

**Example:** `view current`

### Exit

Use the **exit** command to return to the previous prompt level.

**Syntax:**     exit

**Example:**    **exit**



---

## Chapter 13. Using, Configuring and Monitoring FDDI

This chapter describes how to set software configurable information for the Fiber Distributed Data Interface (FDDI) in the router.

This chapter contains the following sections:

- “Accessing the FDDI Configuration Process” on page 13-4
- “Fiber Distributed Data Interface (FDDI) Overview”
- “FDDI Configuration Commands” on page 13-4
- “Accessing the FDDI Console Process” on page 13-7
- “FDDI Console Commands” on page 13-7

---

### Fiber Distributed Data Interface (FDDI) Overview

Fiber Distributed Data Interface (FDDI) is described by the ANSI X3T9.5 and ISO 9314 committees as a dual counter-rotating ring which operates at a defined speed of 100 Mbps.

In many ways, FDDI is similar to the IEEE 802.5 token-ring, although there are differences, some of which are described in “Differences Between FDDI and Token-Ring” on page 13-2.

FDDI is supported by the following protocols:

- IP
- IPX
- AppleTalk

The IPX protocol has a **frame** command that allows you to set the FDDI encapsulation type as follows:

**fddi** Sets the encapsulation type to FDDI IEEE 802.2.

**fddi\_snap** Sets the encapsulation type to FDDI SNAP.

For further information about these protocols, refer to *Multiprotocol Switched Services (MSS) Server Command Line Interface Volume 2*.

### Token-Passing Ring Network

FDDI is defined as a token-passing protocol. Each station has the chance to transmit data when a token passes. A station can decide how many frames it will transmit using an algorithm that permits “bandwidth” allocating.

FDDI also allows a station to transmit many frames without releasing the token in a way that is similar to the IEEE 802.5 token-ring standard.

An FDDI ring network consists of a set of stations/devices connected as a serial string of stations/devices and transmission media to form a physically closed loop. Information is transmitted sequentially as a stream of suitably encoded signals from one active station/device to the next active one.

Each station/device generally regenerates and repeats each token and can serve as the means of attaching one or more stations/devices to the network.

### Primary and Secondary Rings

FDDI defines two rings:

- The **primary ring**, which is similar to the main ring path in a token-ring network.
- The **secondary ring**, which is similar to the backup ring path in a token-ring network.

Each ring path consists of two fibers, each fiber transmitting one signal; one is pushed and one is pulled in a device. Each fiber is equivalent to a pair of copper conductors. The physical approach in terms of fiber optics is similar to physical fiber optic token-ring paths.

### Attachment of Devices

FDDI permits many attachment units:

- Stations or devices
- Concentrators
- Bridges

These units can be attached to FDDI networks in various ways, similar to those for token-ring networks.

### Differences Between FDDI and Token-Ring

The main differences between FDDI and token-ring techniques are:

- A device can be attached directly to rings without a concentrator, such as a multi-station access unit (MAU) on a token ring.
- A device can be attached to either or both of the primary and secondary rings.

FDDI defines two device classes, A and B, to differentiate between devices that attach to one ring or both rings, as described in the next section.

### Device Classes A and B

FDDI defines two device classes:

A **Class A** device attaches to both rings directly.

It may be a station, called a *Class A station* or *Dual Access Station (DAS)*, or it may be a Concentrator, called a *Dual Access Concentrator (DAC)*

A **Class B** device attaches to only one of the rings directly or through a concentrator.

It may be a station, called a *Class B station* or *Single Access Station (SAS)*, or it may be a Concentrator, called a *Single Access Concentrator (SAC)*

FDDI Network Diagram

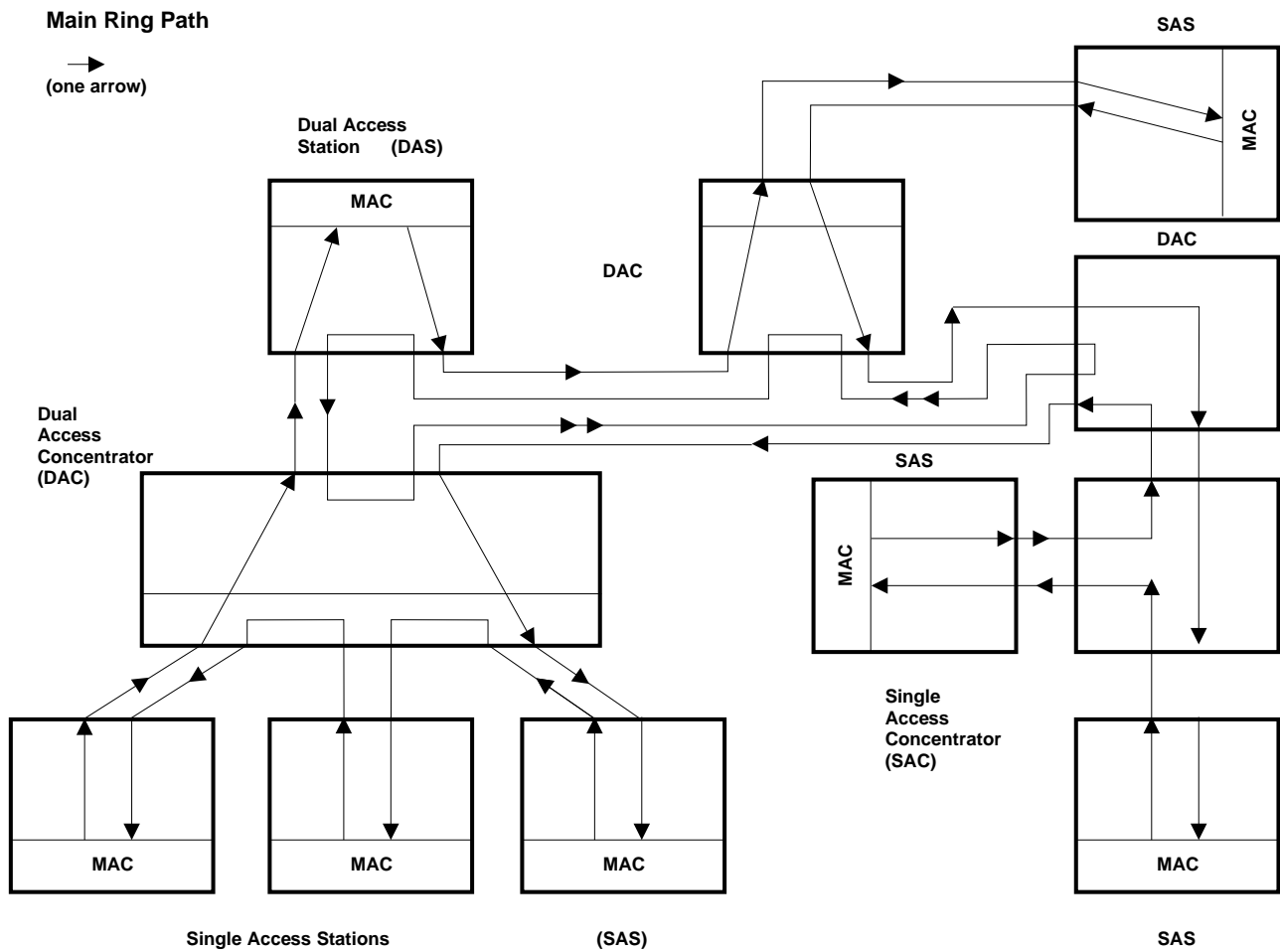

Figure 13-1. FDDI Network Diagram. This diagram shows Single Access Stations (SAS), Dual Access Stations (DAS), Single Access Concentrators (SAC), and Dual Access Concentrators (DAC) in one Main Ring Path of an FDDI network.

---

### Accessing the FDDI Configuration Process

You can access FDDI configuration from Talk 6 by entering the **add device** command to add an FDDI interface to the network and assign an interface number to it and then using the **network** command to access the FDDI interface as shown in the following example:

```
800 Config> add device fddi
SK-NET FDDI device in slot 0 port 1 as interface #2
Use "net 2" to configure SK-NET FDDI parameters

800 Config> network ?
0 :CHARM ATM Adapter
1 :ATM Token Ring LAN Emulation: elan1
2 :SK-NET FDDI

800 Config> network 2
FDDI Interface Configuration
FDD Config>
```

This will get you to the FDDI Config> prompt.

When you are finished, enter **Exit** to return to the previous prompt level.

---

### FDDI Configuration Commands

This section summarizes and then explains all of the FDDI configuration commands as shown in Table 13-1. Enter the commands from the FDDI Config> prompt.

*Table 13-1. FDDI Configuration Command Summary*

Command	Function
<b>? (Help)</b>	Displays all the FDDI commands or lists subcommand options for specific commands.
<b>Frame</b>	Sets IPX encapsulation values.
<b>List</b>	Displays the selected FDDI configuration.
<b>Set</b>	Sets FDDI parameters.
<b>Exit</b>	Exits the FDDI configuration process.

#### ? (Help)

Use the **? (help)** command to list the commands that are available from the current prompt level. You can also enter a ? after a specific command name to list its options.

**Syntax:** ?

**Example:** ?

```
frame
list
set
exit
```

## Frame

Use the **frame** command to set the IPX encapsulation.

**Syntax:** `frame fddi`

`fddi_snap`

`fddi`

Sets the IPX encapsulation to FDDI IEEE 802.2.

`fddi_snap`

Sets the IPX encapsulation to FDDI SNAP.

**Example:**

`frame`

FDDI Config> `frame fddi`

## List

Use the **list** command to display the current configuration for the FDDI.

**Syntax:** `list all`

`ler`

`pmf`

`tmax`

`tmin`

`treq`

`tvx`

`userdata`

`all`

Lists all of the output for the various parameter that follow.

`ler`

Lists the link error rate alarms and cutoff values for port A and port B.

- `a` -- lists the link error rate alarms and cutoff values for port A.
- `b` -- lists the link error rate alarms and cutoff values for port B.

`pmf`

Displays the PMF Password (maximum of 8 characters).

`tmax`

Lists the Maximum Token Rotation Time (in milliseconds).

`tmin`

Lists the Minimum Token Rotation Time (in milliseconds).

`treq`

Lists the Requested Target Token Rotation Time (in milliseconds).

`tvx`

Lists the Valid transmission timer expiration (in microseconds)

`userdata`

Displays the user data (maximum of 32 characters).

**Example:**

`list all`

FDDI> list all

## Set

Use the **set** command to configure FDDI.

**Syntax:** set        ler  
                          pmf  
                          tmax  
                          tmin  
                          treq  
                          tvx  
                          userdata

**ler port# type**

Sets the alarm and cutoff values for port A and port B as follows:

**ler a alarm** Sets the alarm values for port A.

**ler a cutoff** Sets the cutoff values for port A.

**ler b alarm** Sets the alarm values for port B.

**ler b cutoff** Sets the cutoff values for port B.

### Valid values and defaults

Alarm or Cutoff	Valid Values	Default
Alarm	4 to 15	8
Cutoff	4 to 15	7

**pmf**

Sets the PMF Password (maximum of 8 characters).

**tmax**

Sets the Maximum Token Rotation Time (in milliseconds) that this station can accept. Commonly referred to in FDDI specifications as T\_Max.

**Valid values** 5 to 165 milliseconds

**Default** 165 milliseconds

**tmin**

Sets the Minimum Token Rotation Time (in milliseconds) that this station can accept. If the negotiated TTRT is less than this value, then the adapter will not provide proper service to the layers above it. Commonly referred to in FDDI specifications as T\_Min.

**Valid values** 5 to 165 milliseconds

**Default** 5 milliseconds

**treq**

Sets the Requested Target Token Rotation Time (in milliseconds) that this station will bid during initialization. Commonly referred to in FDDI specifications as T\_Req.

**Valid values** 5 to 165 milliseconds

**Default** 165 milliseconds

tvx

Sets the Valid transmission timer expiration (in microseconds). This timer is reset every time a valid frame or nonrestricted token is seen by the station. If the timer expires, it indicates that traffic is not circulating properly on the ring and therefore the claim process is started. Commonly referred to in FDDI specifications as TVX.

**Valid values** 2500 to 10 000 microseconds

**Default** 2 500 microseconds.

userdata

Sets the User data (maximum of 32 characters).

## Exit

Use the **exit** command to return to the previous prompt level.

**Syntax:**    exit

**Example:**   exit

---

## Accessing the FDDI Console Process

You can access FDDI configuration from Talk 5 by entering the **network** command to access the FDDI interface as shown in the following example:

```
800+ network ?
0 :CHARM ATM Adapter
1 :ATM Token Ring LAN Emulation: elan1
2 :SK-NET FDDI
```

```
800 + network 2
FDDI Interface
FDDI+
```

This will get you to the FDDI+ prompt.

When you are finished, enter **Exit** to return to the previous prompt level.

---

## FDDI Console Commands

There are only three console commands for FDDI:

```
? (Help)
List
Exit
```

### ? (Help)

Use the **? (help)** command to list the commands that are available from the current prompt level. You can also enter a ? after a specific command name to list its options.

**Syntax:**    ?

**Example:**   ?

```
list
exit
```

## Monitoring FDDI

### List

Use the **list** command to display the current FDDI configuration parameters.

**Example:**

```
FDDI+ list  
MAC Address: 00:00:5A:00:00:01
```

### Exit

Use the **exit** command to return to the previous prompt level.

**Syntax:** `exit`

**Example:** `exit`



---

## Chapter 14. Using and Configuring MAC Filtering

This chapter describes how to use medium access control (MAC) for specifying packet filters to be applied to packets during processing. It includes the following sections:

- “MAC Filtering Parameters”
- “Accessing the MAC Filtering Configuration Prompt” on page 14-3
- “MAC Filtering Configuration Commands” on page 14-4
- “Update Subcommands” on page 14-9

Filters are a set of rules applied to a packet to determine how the packet should be handled during bridging. MAC filtering affects only bridged traffic.

**Note:** MAC Filtering is allowed on tunnel traffic.

During the filtering process, packets are either processed, filtered, or tagged during bridging. The actions are:

- **Processed** – Packets are permitted to pass unaffected through the bridge.
- **Filtered** – Packets are not permitted to pass through the bridge.
- **Tagged** – Packets are allowed to pass through the bridge, but is marked with a number in the range of 1 through 64 based on a configurable parameter.

A MAC Filter consists of the following three objects:

1. Filter item – which is a single rule that is applied to the address field or an arbitrary window of data within a packet. The result of applying the rule is either a true (successful match) or false (no match) condition.
2. Filter list – which contains a list of one or more filter items.
3. Filter – which contains a set of filter-lists.

---

### MAC Filtering Parameters

You can specify some or all of the following parameters to create a filter:

- Source MAC address or destination MAC address
- Data to be matched within the packet
- Mask to be applied to the packet's fields to be filtered
- Interface number
- Input/Output designation
- Include/Exclude/Tag designation
- Tag value (if the tag designation is given)

### Sliding-Window Filter Parameters

The following parameters are used to construct a sliding window filter-item:

- Base offset of the window data - this is either MAC or INFO.

The base offset (MAC or INFO) specifies whether the location of the data to be matched in the packet is specified via an offset from the beginning of the MAC header or is specified via an offset from the beginning of the information field in the packet.

## Using MAC Filtering

- Offset of the data from base
- Window data - a hex-string
- Window mask - a hex-mask
- Tag - a tag-value

Each sliding window filter-item specifies a sequence of data (up to 32 bytes in length) to match against data in the packet

The window mask is ANDed with the packet data before the comparison with the window data is made.

## Address Filter-Item Parameters

- Address Type: SOURCE or DESTINATION
- Tag: a *tag-value*
- Address Mask: a *hex-mask*

Each filter-item specifies an address type (either SOURCE or DESTINATION) to match against the type in the packet.

The address mask is a string of numbers entered in hex, which is used in comparing the packet's addresses. The mask is applied to the SOURCE or DESTINATION MAC address of the packet before comparing it against the specified MAC address.

The address mask must be of equal length to the MAC address and specifies the bytes that are to be logically ANDed with the bytes in the MAC address before the equality comparison to the specified MAC address is made. If no mask is specified, it is assumed to be all 1s.

## Filter-List Parameters

The following parameters are used to construct a filter-list:

- Name: an *ASCII-string*
- Filter-item list: *filter-item 1 . . . filter-item n*
- Action: INCLUDE, EXCLUDE, TAG(*n*)

A filter-list is built from one or more filter-items. Each filter-list is given a unique name.

Applying a filter-list to a packet consists of comparing each filter-item in the order in which the filter-items were added to the list. If any filter-item in the list returns a TRUE condition then the filter-list will return its designated action.

## Filter Parameters

The following parameters are used to construct a filter:

- Filter-list names: *ASCII-string 1 . . . ASCII-string n*
- Interface number: an *IFC-number*
- Port direction: INPUT or OUTPUT
- Default action: INCLUDE, EXCLUDE, or TAG
- Default tag: a *tag-value*

A filter is constructed by associating a group of filter-list names with an interface number and assigning an INPUT or OUTPUT designation. The application of a filter to a packet means that each of the associated filter-lists should be applied to packets being received (INPUT) or sent (OUTPUT) on the specified numbered interface.

When a filter evaluates a packet to an INCLUDE condition, the packet is forwarded. When a filter evaluates a packet to an EXCLUDE condition, the packet is dropped. When a filter evaluates to a TAG condition, the packet being considered is forwarded with a tag.

An additional parameter of each filter is the default action, which is the result of non-match for all of its filter-lists. This default action is INCLUDE. It can be set to either INCLUDE, EXCLUDE, or TAG. In addition, if the default action is TAG, a tag value is also given.

## Using MAC Filtering Tags

- MAC Address filtering is handled jointly by bandwidth reservation and the MAC Filtering feature (MCF) using tags. A user with bandwidth reservation is able to categorize bridge traffic, for example, by assigning a tag to it.
- The tagging process is done by creating a filter item in the MAC Filtering configuration console and then assigning a tag to it. This tag is then used to set up a bandwidth class for all packets associated with this tag. Tag values must currently be in the range 1 - 64.

**Note:** Tag values are useful in only one respect with Version 1, Release 2. Version 1 Release 2 supports applying tags to **only** bridged packets and allows **only** the MAC address fields of the packet to be used in applying the tag.

- Once a tagged filter has been created in the MAC Filtering configuration process, the Bandwidth Reservation (BRS) **tag** configuration command is used to assign a BRS tag name (either TAG1, TAG2, TAG3, TAG4, or TAG5) to the MAC filter tag number. The BRS tag name is then used on the BRS **assign** configuration command to assign the corresponding MAC filter to a bandwidth traffic class and priority.
- Up to 5 tagged MAC addresses can be set from 1 to 5. TAG1 will be searched for first, then TAG2, all the way to TAG5.

Tags can also refer to “groups” in IP Tunnel. IP Tunnel end-points can belong to any number of groups, with packets assigned to a particular group through the tagging feature of MAC address filtering.

---

## Accessing the MAC Filtering Configuration Prompt

Use the **feature** command from the CONFIG process to access the MAC filtering configuration commands. The **feature** command lets you access configuration commands for specific features outside the protocol and network interface configuration processes.

## Configuring MAC Filtering

Enter a question mark after the **feature** command to obtain a listing of the features available for your software release. For example:

```
Config> feature ?
MCF
Feature name or number [MCF]?
```

To access the MAC filtering configuration prompt, enter the **feature** command followed by the *feature number* (3) or *short name* (MCF). For example:

```
Config> feature mcf
MAC Filtering user configuration
Filter config>
```

Once you access the MAC filtering configuration prompt, you can begin entering specific configuration commands. To return to the CONFIG prompt at any time, enter the **exit** command at the MAC filtering configuration prompt.

---

## MAC Filtering Configuration Commands

This section summarizes and explains the MAC filtering configuration commands. Enter these commands at the Filter config> prompt.

Use the following commands to configure the MAC filtering feature.

Command	Function
<b>? (Help)</b>	Displays all the MAC filtering commands or lists subcommand options for specific commands (if available).
<b>Attach</b>	Adds a filter list to a filter.
<b>Create</b>	Creates a filter list or an INPUT or OUTPUT filter.
<b>Default</b>	Sets the default action for the specified filter to EXCLUDE, INCLUDE, or TAG.
<b>Delete</b>	Removes all information associated with a filter list. Also deletes a filter that was created using the create filter command.
<b>Detach</b>	Deletes a filter list name from a filter.
<b>Disable</b>	Disables MAC Filtering entirely or to disables a particular filter.
<b>Enable</b>	Enables MAC Filtering entirely or enables a particular filter.
<b>List</b>	Lists a summary of all the filter lists and filters configured by the user. Also generates a list of attached filter lists for this filter and all subsequent information for the filter.
<b>Move</b>	Reorders the filter lists attached to a specified filter.
<b>Reinit</b>	Reinitializes the entire MAC Filtering system from an existing configuration without affecting the rest of the router.
<b>Set-Cache</b>	Changes the cache size for a filter.
<b>Update</b>	Adds or deletes information from a specific filter list. Brings you to a menu of appropriate subcommands.
<b>Exit</b>	Exits the MAC filtering configuration process.

## ? (Help)

Use the ? (help) command to list the commands that are available from the current prompt level. You can also enter a ? after a specific command name to list its options.

**Syntax:** ?

**Example:** ?

## Attach

Use the **attach** command to add a filter list to a filter.

A filter is constructed by associating a group of filter lists with an interface number. A filter list is built from one or more filter items.

**Syntax:** `attach filter-list-name filter-number`

**Example:** `attach atm_list 3`

## Create

Use the **create** command to create a filter list or an INPUT or OUTPUT filter.

**Syntax:** `create list filter-list-name  
filter input/output interface-number`

`list filter-list-name`

Creates a filter list. Lists are named by a unique string (Filter-list-name) of up to 16 characters of the user's choice. This name is used to identify a filter list that is being built. This name is also used with other commands associated with the filter list.

**Example:** `create list newyork`

`filter INPUT/OUTPUT interface-number`

Creates a filter and places it on the network associated with the INPUT or OUTPUT direction on the interface given by an interface number. By default this filter is created with no attached filter lists and has a default action of INCLUDE and is ENABLED.

**Example:** `create filter INPUT 2`

## Default

Use the **default** command to set the default action for the filter with a specified filter number to exclude, include, or tag.

**Syntax:** `default exclude filter-number  
include filter-number  
tag tag-number filter-number`

`exclude filter-number`

Sets the default action for the filter with a specified filter number to exclude.

**Example:** `default exclude 3`

`include filter-number`

Sets the default action for the filter with a specified filter number to include.

**Example:** `default include 3`

## Configuring MAC Filtering

`tag tag-number filter-number`

Sets the default action for the filter with the specified filter number to TAG and sets the associated tag value to tag number.

**Example:** `default tag 3 15`

## Delete

Use the **delete** command to remove all information associated with a filter list and to free an assigned string as a name for a new filter list. If filter list is attached to a filter that has already been created by the user, then this command will display an error message on the console without deleting anything. In addition all filter items belonging to this list are also deleted

This command also deletes a filter that was created using the **create filter** command.

**Syntax:** `delete list filter-list  
filter filter-number`

`list filter-list`

Removes all information associated with a filter-list and frees an assigned string as a name for a new filter-list. The filter-list must be a string entered by a previous **create list** command.

If the filter-list is attached to a filter that has already been created by the user, then this command will display an error message on the console without deleting anything. All filter-items belonging to this list are also deleted when this command is used.

**Example:** `delete list newyork`

`filter filter-number`

Deletes a filter that was created using the **create filter** command.

**Example:** `delete 3`

## Detach

Use the **detach** command to delete a filter-list name (filter-list parameter) from a filter (filter-number parameter).

**Syntax:** `detach list filter-list`

**Example:** `detach list newyork`

## Disable

Use the **disable** command to disable MAC Filtering entirely or to disable a particular filter.

**Syntax:** `disable all  
filter filter-number`

`all`

Disables MAC Filtering entirely. Filters are still set as ENABLED, however, if they were enabled previously.

**Example:** `disable all`

*filter filter-number*

Disables a particular filter. The filter-number parameter corresponds to the numbers displayed in the **list filters** command.

**Example:** `disable filter 3`

## Enable

Use the **enable** command to enable MAC Filtering entirely or to enable a particular filter.

**Syntax:** `enable all`  
`filter filter-number`

*all*

Enables MAC Filtering entirely although filters themselves may still be set to DISABLED.

**Example:** `enable all`

*filter filter-number*

Enables a particular filter. The filter-number parameter corresponds to the numbers displayed in the **list filters** command.

**Example:** `enable filter 3`

## List

Use the **list** command to list a summary of all the filter-lists and filters configured by the user. A list of all the filter-lists attached to a filter is not given. Other information displayed includes:

- A list containing the state of the filtering system (ENABLE, DISABLE)
- The set of configured filter-list records
- Each of the configured filter records.

In addition, the following information is displayed for each filter:

- Filter number
- Interface number
- Filter direction (INPUT, OUTPUT)
- Filter state (ENABLE, DISABLE)
- Filter default action (TAG, INCLUDE, EXCLUDE).

This command also generates a list of attached filter-lists for this filter and all subsequent information for the filter.

**Syntax:** `list all`  
`filter filter-number`

**Example:** `list all`

*filter filter-number*

Generates a list of attached filter-lists for the specified filter and all subsequent information for the filter.

**Example:** `list filter 3`

## Configuring MAC Filtering

### Move

Use the **move** command to reorder the filter-lists attached to a specified filter (given by filter-number parameter). The list given by Filter-list-name1 is moved immediately before the list given by Filter-list-name2.

**Syntax:** `move filter-list-name1 filter-list-name2 filter-number`

**Example:** `move newyork boston 13`

### Reinit

Use the **reinit** command to reinitialize the entire MAC Filtering system from an existing configuration without affecting the rest of the router.

**Syntax:** `reinit`

**Example:** `reinit`

### Set-Cache

Use the **set-cache** command to change the default cache size (16) to a number between 4 and 32768.

**Syntax:** `set-cache cache-size filter-number`

**Example:** `set-cache 32 13`

### Update

Use the **update** command to add information to or delete information from a specific filter-list. Using this command with the desired filter-list-name brings you to the `Filter filter-list-name Config>` prompt for that specific filter list. From this new prompt you can then change information in the specified list.

The new prompt level is used to add or delete filter-items from filter-lists. The order in which the filter-items are specified for a given filter-list is important as it determines the order in which the filter-items are applied to a packet.

**Syntax:** `update filter-list-name`

**Example:** `update newyork`

### Exit

Use the **exit** command to return to the previous CONFIG prompt level.

**Syntax:** `exit`

**Example:** `exit`



## Update Subcommands

This section summarizes and then explains the MAC filtering configuration subcommands. Enter these subcommands at the Filter `filter-list-name` `config>` prompt.

Table 14-2. Update Subcommands Summary

Subcommand	Function
<b>? (Help)</b>	Displays all the update subcommands.
<b>Add</b>	Adds source or destination MAC address filters or a window filter. Adds filter-items to a filter-list.
<b>Delete</b>	Removes filter-items from a filter-list.
<b>List</b>	Lists a summary of all the filter-lists and filters configured by the user. Also generates a list of attached filter-lists for this filter and all subsequent information for the filter.
<b>Move</b>	Reorders the filter-lists attached to a specified filter.
<b>Set-Action</b>	Sets a filter-item to evaluate the INCLUDE, EXCLUDE or TAG (with a tag-number option) condition.
<b>Exit</b>	Exits the update subcommand configuration process.

Use the following subcommands to update a filter-list.

### ? (Help)

Use the **? (help)** subcommand to list the commands that are available from the current prompt level. You can also enter a **?** after a specific subcommand name to list its options.

**Syntax:** ?

**Example:** ?

### Add

Use the **add** subcommand to add filter-items to a filter-list. This subcommand specifically lets you add a hexadecimal number to compare against the source or destination MAC address, source or destination MAC address, or a sequence of window data with a mask to compare against packet data.

The order in which the filter-items are added to a given filter-list is important as it determines the order in which the filter-items are applied to a packet.

Each use of the **add** subcommand creates a filter-item within the filter-list. The first filter-item created is assigned filter-item-number 1, the next one is assigned number 2, etc. After a successful **add** subcommand is entered by the user, the router displays the number of the filter-item just added.

The first match that occurs stops the application of filter-items, and the filter-list evaluates to either INCLUDE, EXCLUDE or TAG, depending on the designated action of the filter-list. If none of the filter-items of a filter-list produce a match, then the default action (INCLUDE, EXCLUDE or TAG) of the filter is returned.

**Syntax:** `add source hex-MAC-addr hex-Mask`

## Update Subcommands

destination *hex-MAC-addr hex-Mask*  
window MAC *offset-value hex-data hex-mask*  
window INFO *offset-value hex-data hex-mask*

source *hex-MAC-addr hex-Mask*

Adds a hexadecimal number (with no 0x in front, a maximum of 16 numbers, and an even number of hex numbers) to compare against the source MAC address.

The hex-mask parameter must be the same length as hex-MAC-address and is logically ANDed with the designated MAC address in the packet. The default hex-mask argument is to be all binary 1s.

The hex-MAC-addr parameter can be specified in canonical or noncanonical bit order. A canonical bit order is specified as just a hex number (e.g., 000003001234). It may also be represented as a series of hex digits with a hyphen (-) between every two digits (e.g., 00-00-03-00-12-34).

A noncanonical bit order is specified as a series of hex digits with a colon (:) between every two digits (e.g., 00:00:C9:09:66:49). MAC addresses of filter-items will always be displayed using either "-" or ":" to distinguish canonical from noncanonical representations.

**Example:** `add source 00-00-03-00-12-34 00-00-00-00-12-34`

destination *hex-MAC-addr hex-Mask*

Acts identically to the add source subcommand, with the exception that the match is made against the destination rather than source MAC address of the packet.

**Example:** `add destination 00-00-03-00-12-34 00-00-00-00-12-34`

window MAC *offset-value hex-data hex-mask*

Adds a sliding window filter-item using the specified offset (computed from the beginning of the frame) which matches the hex data with the mask against packet data.

**Example:** `add window mac 14 f4f403 ffffff`

window INFO *offset-value hex-data hex-mask*

Similar to the **add window mac** command, except the offset is computed with respect to the beginning of the information field.

**Example:** `add window info 0 f4f403 ffffff`

## Delete

Use the **delete** subcommand to remove filter-items from a filter-list. You delete filter items by specifying the filter-item-number assigned to the item when it was added.

When the **delete** subcommand is used, any gap created in the number sequence is filled in. For example, if filter-items 1, 2, 3, and 4 exist and filter-item 3 is deleted, then filter-item 4 will be renumbered to 3.

**Syntax:** `delete filter-item-number`

**Example:** `delete 3`

## List

Use the **list** subcommand to print out a listing of all the filter-item records represented in canonical and noncanonical form. the sliding window and MAC address filter-item records. The following information about each MAC-Address filter item is displayed:

- MAC address and address mask in canonical or noncanonical form.
- filter-item numbers
- address type (source or destination)
- filter-list action is given.

**Syntax:** list        canonical  
                          noncanonical  
                          mac-address canonical  
                          mac-address noncanonical  
                          window

### canonical

Prints out a listing of all the filter-item records within a filter-list, giving the item numbers, the address type (SRC, DST), the MAC address in canonical form and the address mask in canonical form. In addition the filter-list action is given.

### mac-address canonical

Prints out a listing of all the filter-item records within a filter-list, giving the item numbers, the address type (SRC, DST), the MAC address in canonical form and the address mask in canonical form. In addition the filter-list action is given.

**Example:**    **list canonical**  
                          **list mac-address canonical**

### noncanonical

Prints out a listing of all the filter-item records within a filter-list, giving the item numbers, the address type (SRC, DST), the MAC address in noncanonical form and the address mask in noncanonical form. In addition the filter-list action is given.

### mac-address noncanonical

Prints out a listing of all the filter-item records within a filter-list, giving the item numbers, the address type (SRC, DST), the MAC address in noncanonical form and the address mask in noncanonical form. In addition the filter-list action is given.

**Example:**    **list noncanonical**  
                          **list mac-address noncanonical**

### window

Prints out a listing of all the sliding window filter-item records within a filter-list, giving the item numbers, base, offset, data, and mask. In addition the filter-list action is given.

**Example:**    **list window**

## Update Subcommands

### Move

The **move** subcommand reorders filter-items within the filter-list. The filter-item whose number is specified by *filter-item-name1* is moved and renumbered to be just before *filter-item-name2*.

**Syntax:** `move` *filter-item-name1* *filter-item-name2*

**Example:** `move 2 4`

### Set-Action

The **set-action** subcommand lets you set a filter-item to evaluate the INCLUDE, EXCLUDE, or TAG (with a tag-number option) condition. If one of the filter-items of the filter-list matches the contents of the packet being considered for filtering, the filter-list will evaluate to the specified condition. The default setting is INCLUDE.

**Syntax:** `set-action` *INCLUDE or EXCLUDE or TAG tag-number*

**Example:** `set action EXCLUDE`

### Exit

Use the **exit** subcommand to return to the previous prompt level.

**Syntax:** `exit`

**Example:** `exit`

---

## Chapter 15. Monitoring MAC Filtering

This chapter describes how to access the MAC Filtering console prompt and describes the available console commands. It includes the following sections:

- “Accessing the MAC Filtering Console Prompt”
- “MAC Filtering Console Commands”

---

### Accessing the MAC Filtering Console Prompt

Use the **feature** command from the GWCON process to access the MAC filtering console commands. The **feature** command let you access console commands for specific router features outside of the protocol and network interface console processes.

Enter a question mark after the **feature** command to obtain a listing of the features available for your software release. For example:

```
+ feature ?
MCF
```

To access the MAC filtering console prompt, enter the **feature** command followed by the feature number (3) or short name (MCF). For example:

```
+ feature mcf
MAC Filtering user console
Filter>
```

Once you access the MAC filtering console prompt, you can begin entering specific console commands. To return to the GWCON prompt at any time, enter the **exit** command at the MAC Filtering console prompt.

---

### MAC Filtering Console Commands

This section summarizes and explains the MAC filtering console commands. Enter these commands at the `Filter>` prompt.

*Table 15-1. MAC Filtering Console Command Summary*

Command	Function
<b>? (Help)</b>	Displays all the MAC filtering commands or lists subcommand options for specific commands (if available).
<b>Clear</b>	Clears the "per filter" statistics listed in the list filter command.
<b>Disable</b>	Disables MAC Filtering globally or on a "per filter" basis.
<b>Enable</b>	Enables MAC Filtering globally or on a "per filter" basis.
<b>List</b>	Lists a summary of statistics and settings for each filter currently running in the router.
<b>Reinit</b>	Reinitializes the entire MAC Filtering system from an existing console without affecting the rest of the router.
<b>Exit</b>	Exits the MAC filtering console process.

Use the following commands to monitor the MAC filtering feature.

## Monitoring MAC Filtering

### ? (Help)

Use the ? (help) command to list the commands that are available from the current prompt level. You can also enter a ? after a specific command name to list its options.

**Syntax:** ?

**Example:** ?

### Clear

Use the clear command to clear all the filter statistics.

**Syntax:** clear     all  
                  filter *filter-number*

all

Clears the statistics listed by the **list all** command.

**Example:**   clear all

filter *filter-number*

Clears the statistics listed by the **list filter** command.

**Example:**   clear filter 3

### Disable

Use the **disable** command to disable MAC filtering globally. This command does not individually disable each filter.

The command also disables a filter as specified by filter-number. This filter is disabled without modifying configuration records. If no argument is given, MAC filtering is globally disabled.

**Syntax:** disable   all  
                  filter *filter-number*

all

Disables MAC filtering globally. This command does not individually disable each filter.

**Example:**   disable all

filter *filter-number*

Disables the filter that is specified by the filter number. This filter is disabled without modifying configuration records. If no filter number is given, MAC filtering is globally disabled.

**Example:**   disable filter 3

### Enable

Use the **enable** command to enable MAC filtering globally. This command does not individually enable each filter.

The command also enables a filter as specified by filter-number. This filter is enabled without modifying configuration records. If no argument is given, MAC filtering is globally enabled.

**Syntax:** enable    all  
                  filter *filter-number*

all

Enables MAC filtering globally. This command does not individually enable each filter.

**Example:** `enable all`

filter *filter-number*

Enables the filter that is specified by the filter number. This filter is enabled without modifying configuration records. If no filter number is given, MAC filtering is globally enabled.

**Example:** `enable filter 3`

## List

Use the **list** command to list a summary of statistics and settings for each filter currently running in the router. The following information is displayed for each filter when the **list all** command is used:

- default action
- cache size
- default tag
- state (enabled/disabled)
- number of packets which have been filtered as INCLUDE, EXCLUDE or TAG.

In addition, the following information is also displayed by the **list filter** command for a specified filter:

- all information displayed by the list all command
- all the filter-lists currently running in this filter including:
  - list name
  - list action
  - list tag
  - number of packets which have been filtered by each filter-list.

**Syntax:** list           all  
                              filter *filter-number*

all

Lists statistics and settings for each filter currently running in the router.

**Example:** `list all`

filter *filter-number*

Generates statistics and settings for each filter plus all the filter-lists currently running in this filter.

**Example:** `list filter 3`

## Reinit

Use the **reinit** command to reinitialize the entire MAC Filtering system from an existing configuration without affecting the rest of the router.

**Syntax:** reinit

Example: `reinit`

## Monitoring MAC Filtering

### Exit

Use the **exit** command to return to the previous GWCON prompt level.

**Syntax:** exit

**Example:** exit



---

## Chapter 16. Using and Configuring Quality of Service (QoS)

This chapter describes how to configure the Quality of Service (QoS) feature in the router.

---

### Quality of Service (QoS) Overview

The QoS feature leverages the benefits of ATM QoS capabilities for LAN Emulation Data Direct VCCs. This support is referred to as “Configurable QoS for LAN Emulation.” The key attributes and the benefits of this feature are summarized below:

- An LE Client makes use of configured QoS parameters for its Data Direct VCCs.
- QoS parameters can be configured for:
  - LE Client
  - Emulated LAN
  - ATM Interface
- The set of QoS parameters configured are for use with ATM Forum UNI 3.0/3.1 signalling. The parameters include the desired Peak Cell Rate, Sustained Cell Rate, QoS Class and Maximum Burst Size.
- Maximum Reserved Bandwidth per VCC can be configured which protects an LE Client from accepting/establishing VCCs whose traffic parameters it cannot support.
- QoS Negotiation mechanism enables the participating LE Clients to be aware of each other's QoS parameters. A data-direct VCC is set up using the negotiated parameters.

### Benefits of QoS

- The configured QoS parameters for the LE Client, ATM Interface or Emulated LAN enable QoS for LANE Data Direct VCCs.
  - An LE Client can be configured with QoS if the QoS required by the client is different than the QoS required by other clients on the ELAN. For example, if an LE Client serves a file server then the user may desire to configure appropriate QoS parameters for all traffic to/from the file server.
  - An Emulated LAN can be configured with QoS if the user wishes to provide QoS for all traffic in that ELAN. For example, if an ELAN realizes an SNA network which is used for applications more important than those on the other ELANs, the user can give the SNA traffic priority by configuring QoS for its ELAN.
  - An ATM Interface can be configured with QoS if a user desires that all LE Clients on that ATM interface use the same set of parameters. For example, if an ATM Interface is connected at 25 Mbps the user may configure appropriate parameters which are different from those at a 155 Mbps interface.

### QoS Configuration Parameters

This section describes nine parameters which are used for QoS configuration.

The following six parameters can be configured for an LE Client, ATM Interface and an Emulated LAN:

1. max-reserved-bandwidth
2. traffic-type
3. peak-cell-rate
4. sustained-cell-rate
5. max-burst-size
6. qos-class

The following two parameters can be configured for an Emulated LAN and an LE Client:

7. validate-pcr-of-best-effort-vccs
8. negotiate-qos

The following parameter can be configured only for an LE Client:

9. accept-qos-parms-from-lecs

The first six parameters control the traffic characteristics of Data Direct VCCs established by the LE Client while the first parameter also applies to the calls received by the LE Client. The following characteristics are associated with all the Data Direct VCCs established by the LE Client:

- Bandwidth is not reserved for best-effort traffic,
- Traffic parameters apply to both forward and backward directions,
- When a reserved bandwidth connection is rejected due to the traffic parameters or QoS Class, the call is retried as a best-effort connection with the configured peak cell rate (cause codes on release or release-complete messages are used to determine why a VCC was released).
- When a best-effort connection is rejected due to the Peak Cell Rate (PCR), the call may be automatically retried with a lower PCR. Retries may be performed under the following conditions:
  1. If the rejected PCR is greater than 100 Mbps, the call is retried with a PCR of 100 Mbps.
  2. Otherwise, if the rejected PCR is greater than 25 Mbps, the call is retried with a PCR of 25 Mbps.

#### **Maximum Reserved Bandwidth (max-reserved-bandwidth)**

The maximum reserved bandwidth acceptable for a Data Direct VCC. This parameter applies to both Data Direct VCC calls received by the LE Client and Data Direct VCC calls placed by the LE Client. For incoming calls, this parameter defines the maximum acceptable SCR for a Data Direct VCC. If SCR is not specified on the incoming call, then this parameter defines the maximum acceptable PCR for a Data Direct VCC with reserved bandwidth.

Calls received with traffic parameters specifying higher rates will be released. If SCR is specified on the incoming call, the call will not be rejected due to the PCR or Maximum Burst Size. The constraint imposed by this parameter is not applicable to BEST\_EFFORT connections. For outgoing calls, this parameter sets an upper bound on the amount of reserved bandwidth that may be requested for a Data Direct VCC. Therefore the traffic-type and sustained-cell-rate parameters are dependent upon this parameter.

**Valid Values:** Integer in the range 0 to the line speed of ATM device in Kbps  
**Default Value:** 0

### Traffic Type (traffic-type)

The desired traffic type for Data Direct VCCs. If QoS parameters are not negotiated, then this parameter specifies the type of calls placed by the LE Client. Otherwise, if QoS parameters are negotiated, this parameter specifies the desired type of traffic characteristics for Data Direct VCCs. When QoS parameters are negotiated, if either the source or target LEC desires a reserved bandwidth connection and both LECs support reserved bandwidth connections (i.e., max-reserved-bandwidth > 0), then an attempt will be made to establish a reserved bandwidth Data Direct VCC between the two LECs. Otherwise, the Data Direct VCC will be a best-effort connection. Dependencies: max-reserved-bandwidth

**Valid Values:** BEST\_EFFORT or RESERVED\_BANDWIDTH  
**Default:** BEST EFFORT.

### Peak Cell Rate (peak-cell-rate)

The desired peak cell rate for Data Direct VCCs. If QoS parameters are not negotiated, then this parameter specifies the PCR traffic parameter for Data Direct VCC calls placed by the LE Client. Otherwise, if QoS parameters are negotiated, this parameter specifies the desired PCR traffic parameter for Data Direct VCCs. The minimum of the desired PCRs of the two LECs is used for negotiated best-effort VCCs.

When a reserved bandwidth VCC is negotiated and only one of the LE Clients requests a reserved bandwidth connection, then the desired PCR of that LEC is used for the Data Direct VCC subject to the upper bound imposed by the line rate of the local ATM device. If both LECs request a reserved bandwidth connection, then the maximum of the desired PCRs of the LE Clients is used for the Data Direct VCC subject to the upper bound imposed the line rate of the local ATM device.

**Valid Values:** An integer value in the range 0 to the line speed of ATM device in Kbps  
**Default Value:** Line speed of LEC ATM Device in Kbps.

### Sustained Cell Rate (sustained-cell-rate)

The desired sustained cell rate for Data Direct VCCs. If QoS parameters are not negotiated, then this parameter specifies the SCR traffic parameter for Data Direct VCC calls placed by the LE Client. Otherwise, if QoS parameters are negotiated, this parameter specifies the desired SCR traffic parameter for Data Direct VCCs.

When a reserved bandwidth VCC is negotiated and only one of the LE Clients requests a reserved bandwidth connection, then the desired SCR of that LEC is used for the Data Direct VCC (subject to the upper bound imposed by the max-reserved-bandwidth parameter of the other LEC). If both LECs request a reserved bandwidth connection, then the maximum of the desired SCRs of the LE Clients is used for the Data Direct VCC (subject to the upper bound imposed by the max-reserved-bandwidth parameters of both LECs). In any case (negotiation or not), if the SCR that is to be signalled equals the PCR that is to be signalled, then the call is signalled with PCR only.

Dependencies: max-reserved-bandwidth, traffic-type and peak-cell-rate. This parameter is applicable only when traffic-type is RESERVED\_BANDWIDTH.

## Using and Configuring Quality of Service (QoS)

**Valid Values:** An integer value in the range 0 to the minimum of max-reserved-bandwidth and peak-cell-rate, specified in Kbps  
**Default Value** None

### Maximum Burst Size (max-burst-size)

The desired maximum burst size for Data Direct VCCs. If QoS parameters are not negotiated, then this parameter specifies the Maximum Burst Size traffic parameter for Data Direct VCC calls placed by the LE Client. Otherwise, if QoS parameters are negotiated, this parameter specifies the desired Maximum Burst Size traffic parameter for Data Direct VCCs.

When a reserved bandwidth VCC is negotiated and only one of the LE Clients requests a reserved bandwidth connection, then the desired Maximum Burst Size of that LEC is used for the Data Direct VCC. If both LECs request a reserved bandwidth connection, then the maximum of the desired Maximum Burst Sizes of the LE Clients is used for the Data Direct VCC.

In any case (negotiation or not), the Maximum Burst Size is signalled only when SCR is signalled. Although this parameter is expressed in units of cells, it is configured as an integer multiple of the Maximum Data Frame Size (specified in LEC's C3 parameter) with a lower bound of 1.

**Dependencies:** This parameter is applicable only when traffic-type is RESERVED\_BANDWIDTH.

**Valid Values:** An integer number of frames; must be greater than 0  
**Default:** 1 frame

### QoS Class (qos-class)

The desired QoS class for reserved bandwidth calls. If QoS parameters are not negotiated, then this parameter specifies the QoS Class to be used for reserved bandwidth Data Direct VCC calls placed by the LE Client. Otherwise, if QoS parameters are negotiated, this parameter specifies the QoS Class that is desired for Data Direct VCCs. Unspecified QoS Class is always used on best-effort calls. Specified QoS Classes define objective values for ATM performance. Specified QoS Classes define objective values for ATM performance parameters such as cell loss ratio and cell transfer delay.

The UNI Specification states that:

- Specified QoS Class 1* Should yield performance comparable to current digital private line performance.
- Specified QoS Class 2* is intended for packetized video and audio in teleconferencing and multimedia applications.
- Specified QoS Class 3* Is intended for interoperation of connection oriented protocols, such as frame relay.
- Specified QoS Class 4* Is intended for interoperation of connectionless protocols, such as IP or SMDS.

LECs must be able to accept calls with any of the above QoS Classes. When QoS parameters are negotiated, the configured QoS Classes of the two LECs are compared, and the QoS Class with the more stringent requirements is used.

**Valid Values:** 0: for Unspecified QoS Class  
1: for Specified QoS Class 1  
2: for Specified QoS Class 2  
3: for Specified QoS Class 3  
4: for Specified QoS Class 4  
**Default Value:** 0 (Unspecified QoS Class)

### **Validate PCR of Best-Effort VCCs (validate-pcr-of-best-effort-vccs)**

To validate Peak Cell Rate of Best-Effort VCCs. When FALSE, best-effort VCCs will be accepted without regard to the signalled forward PCR. When TRUE, best-effort VCCs will be rejected if the signalled forward PCR exceeds the line rate of the LE Client ATM device. Calls will not be rejected due to the backward PCR. The signalled backward PCR will be honored if it does not exceed the line rate; otherwise, transmissions to the caller will be at line rate.

#### **Notes:**

1. Accepting best-effort VCCs with forward PCRs that exceed the line rate can result in poor performance due to excessive retransmissions; however, rejecting these VCCs can result in interoperability problems.
2. The YES setting is useful when callers will retry with a lower PCR following call rejection due to unavailable cell rate.

**Valid Values:** YES,NO  
**Default Value:** NO

### **Negotiate QoS (negotiate-qos)**

Enable QoS parameter negotiation for Data Direct VCCs. This parameter should only be enabled when connecting to an IBM MSS LES. When this parameter is YES, the LE Client will include an IBM Traffic Parameter TLV in LE\_JOIN\_REQUEST and LE\_ARP\_RESPONSE frames sent to the LES. This TLV will include the values of max-reserved-bandwidth, traffic-type, peak-cell-rate, sustained-cell-rate, max-burst-size and qos-class. An IBM Traffic Parameter TLV may also be included in a LE\_ARP\_RESPONSE returned to the LE Client by the LES.

If there is no TLV in a LE\_ARP\_RESPONSE received by the LE Client, then the local configuration parameters must be used to setup the Data Direct VCC. If a TLV is included in a LE\_ARP\_RESPONSE, the LE Client must compare the contents of the TLV with the corresponding local values to determine the "negotiated" or "best" set of parameters acceptable to both parties before signalling for the Data Direct VCC.

**Valid Values:** YES,NO  
**Default Value:** NO

### **Accept QoS Params from LECS (accept-qos-params-from-lecs)**

This parameter gives the ability to configure an LE Client to accept/reject QoS parameters from an LECS. When this parameter is YES, the LE Client should use the QoS parameters obtained from the LE ClientS in the LE\_CONFIGURE\_RESPONSE frames i.e., the QoS parameters from the LE ClientS override the locally configured QoS parameters. If this parameter is NO then the LE Client will ignore any QoS parameters received in an LE\_CONFIGURE\_RESPONSE frame from the LE ClientS.

**Valid Values:** YES,NO  
**Default Value:** YES

---

### Accessing the QoS Configuration Prompt

Use the **feature** command from the CONFIG process to access the Quality of Service configuration commands. Enter **feature** followed by the feature number (6) or short name (QOS). For example:

```
Config> feature qos  
Configurable Quality of Service for LAN Emulation  
QoS Config>
```

Once you access the QoS Config> prompt, you can now choose to configure Quality of Service (QoS) an LE Client, an ATM Interface or an Emulated LAN. To return to the Config> prompt at any time, enter the **exit** command at the QoS Config> prompt.

Alternatively, QoS parameters can be configured for an LE Client, ATM Interface or an Emulated LAN by accessing the entities as follows:

- LE Client
  1. At the Config> prompt, enter the **network** command and the LE Client interface number.
  2. At the LE Client configuration> prompt enter **qos-configuration**.

**Example:**

```
config> network 3  
Token Ring Forum Compliant LEC Config> qos-configuration  
elan-x LEC QoS Config>
```

- ATM Interface
  1. at the Config> prompt, enter the **network** command and the ATM interface number to get you to the ATM Config> prompt.
  2. Enter the **interface** parameter to get you to the ATM Interface Config> prompt.
  3. At the ATM InterfaceConfig> prompt enter **qos-configuration**.

**Example:**

```
config> network 0  
ATM Config> interface  
ATM Interface Config> qos-configuration  
ATM-I/F 0 QoS>
```

- Emulated LAN
  1. At the Config> prompt, enter the **network** command and the ATM interface number to get you to the ATM Config> prompt.
  2. Enter **le-service** to get you to the LE Services config> prompt.
  3. Enter **lecs** to get you to the LECS config> prompt.
  4. At the LECS config> prompt enter **elans** to get you to the LECS ELANS configuration> prompt.

5. Select an ELAN by entering **select elan elan-x**, where “elan-x” is the ELAN you wish to configure. This will get you to the Selected ELAN '`.elan-x`'> prompt.
6. At the Selected ELAN '`.elan-x`'> prompt, QoS parameters can be configured as TLVs. See “Detailed Configuration of an ELAN at the LECS” on page 23-23.

**Example:**

```

config> network 0
ATM Config> le-services
LE Services config> lecs
LECS config> elans
LECS ELANS config> select elan elan-x
Selected ELAN '.elan-x'>

```

---

## Quality of Service (QoS) Commands

This section summarizes and explains the QoS configuration commands. Enter these commands at the LE QoS `config>` prompt.

Use the following commands to configure Quality of Service. Enter the commands from the QoS `Config>` prompt.

*Table 16-1. Quality of Service (QoS) Configuration Command Summary*

Command	Function
<b>? (Help)</b>	Displays all the QoS configuration commands.
<b>LE-CLIENT</b>	Gets you to the LE Client QoS configuration > prompt for the selected LE client.
<b>ATM-INTERFACE</b>	Gets you to the ATM Interface QoS configuration> prompt for the selected ATM interface.
<b>ELAN (at LECS)</b>	Gets you to the ELAN QoS configuration> prompt at LECS for configuring QoS parameters.
<b>Exit</b>	Exits the QoS configuration process.

---

## LE Client QoS Configuration Commands

This section summarizes and explains the commands for configuring QoS for a specific LE Client.

Use the following commands at the `elan-x LEC QoS config>` prompt.

*Table 16-2. LE Client Quality of Service (QoS) Configuration Command Summary*

Command	Function
<b>? (Help)</b>	Displays all the LE Client QoS configuration commands, or displays the parameters associated with specific commands.
<b>List</b>	Lists the current QoS configuration of the LE Client.
<b>Set</b>	Sets the QoS parameters of the LE Client.
<b>Remove</b>	Removes the QoS configuration of the LE Client.
<b>Exit</b>	Returns to the previous prompt level.

### ? (Help)

Use the **? (help)** command to list the commands that are available from the current prompt level. You can also enter a ? after a specific command name to list its options.

**Syntax:** ?

**Example:** ?

```
list
set
remove
exit
```

### List

Use the **list** command to list the QoS configuration of this LE Client. QoS parameters are listed only if at least one has been specifically configured (see example 1 below). Otherwise, no parameters are listed (see example 2 below).

**Syntax:** list

**Example 1:**

```
elan-x LEC QoS Config> list
```

```
      ATM LEC  Quality of Service' Configuration
      =====
(ATM interface number = 0,  LEC interface number = 3)
```

```
Maximum Reserved Bandwidth for a Data-Direct VCC = 10000 Kbps
Data-Direct VCC Type ..... = Best-Effort
Data-Direct VCC Peak Cell Rate ..... = 155000 Kbps
Data-Direct VCC Sustained Cell Rate ..... = 155000 Kbps
Desired QoS Class of Reserved Connections ..... = 0
Max Burst Size of Reserved Connections ..... = 0 frames
```

```
Validate Peak Rate of Best-Effort connections .. = No
Enable QoS Parameter Negotiation ..... = Yes
Accept QoS Parameters from LECS ..... = Yes
```

```
elan-x LEC QoS Config>
```

**Example 2:**

```
elan-x LEC QoS Config>
```

```
QoS has not been configured for this LEC.
Please use the SET option to configure QoS.
```

```
elan-x LEC QoS Config>
```

### Set

Use the **set** command to specify LE Client QoS parameters.

**Syntax:** set

- all-default-values
- max-reserved-bandwidth
- traffic-type
- peak-cell-rate
- sustained-cell-rate
- max-burst-size
- qos-class
- validate-pcr-of-best-effort-vccs
- negotiate-qos
- accept-qos-parms-from-lecs



**all-default-values**

Use this option to set the QoS parameters to default values. In the below example the default values are also listed.

**Example:**

```

elan-x LEC QoS Config> set all-default-values
Failed to locate existing QoS configuration record!
Using a new set of default values ...
Initializing all parameters to default values
elan-x LEC QoS Config> list

      ATM LEC Quality of Service' Configuration
      =====
      (ATM interface number = 0, LEC interface number = 3)

      Maximum Reserved Bandwidth for a Data-Direct VCC = 0 Kbps
      Data-Direct VCC Type ..... = Best-Effort
      Data-Direct VCC Peak Cell Rate ..... = 155000 Kbps
      Data-Direct VCC Sustained Cell Rate ..... = 155000 Kbps
      Desired QoS Class of Reserved Connections ..... = 0
      Max Burst Size of Reserved Connections ..... = 0 frames

      Validate Peak Rate of Best-Effort connections .. = No
      Enable QoS Parameter Negotiation ..... = No
      Accept QoS Parameters from LECS ..... = Yes

elan-x LEC QoS Config>

```

**max-reserved-bandwidth**

Use this option to set the maximum reserved bandwidth allowable per Data Direct VCC. See "Maximum Reserved Bandwidth (max-reserved-bandwidth)" on page 16-2 for a more detailed description of this parameter.

**Valid Values:** Integer in the range 0 to the line speed of ATM device in Kbps

**Default Value:** 0

**Example:**

```

elan-x LEC QoS Config> set max-reserved-bandwidth
Maximum reserved bandwidth acceptable for a data-direct VCC (in Kbps) [0]? 20000
elan-x LEC QoS Config>

```

**traffic-type**

Sets the desired traffic for Data Direct VCCs. See "Traffic Type (traffic-type)" on page 16-3 for a more detailed description of this parameter.

**Valid Values:** BEST\_EFFORT or RESERVED\_BANDWIDTH

**Default:** BEST EFFORT.

**Example:**

```

elan-x LEC QoS Config> set traffic-type
Choose from:
  (0): Best-Effort
  (1): Reserved-Bandwidth
Data Direct VCC Type [0]? 1
NOTE: Peak Cell Rate has been reset to 1
      Sustained Cell Rate has been reset to 1
      Please configure appropriate values.
elan-x LEC QoS Config>

```

**peak-cell-rate**

Sets the desired peak cell rate for Data Direct. See "Peak Cell Rate (peak-cell-rate)" on page 16-3 for a more detailed description of this parameter.

**Valid Values:** An integer value in the range 0 to the line speed of ATM device in Kbps

**Default Value:** Line speed of LEC ATM Device in Kbps.

**Example:**

```
elan-x LEC QoS Config> set peak-cell-rate
Data-Direct VCC Peak Cell Rate in Kbps [1]? 25000
elan-x LEC QoS Config>
```

### sustained-cell-rate

Sets the desired sustained cell rate for Data Direct VCCs. See “Sustained Cell Rate (sustained-cell-rate)” on page 16-3 for a more detailed description of this parameter.

**Valid Values:** An integer value in the range 0 to the minimum of max-reserved-bandwidth and peak-cell-rate, specified in Kbps

**Default Value** None

**Example:**

```
elan-x LEC QoS Config> se sus
Data-Direct VCC Sustained Cell Rate in Kbps [1]? 10000
elan-x LEC QoS Config>
```

### max-burst-size

Sets the desired maximum burst size in frames. See “Maximum Burst Size (max-burst-size)” on page 16-4 for a more detailed description of this parameter.

**Valid Values:** An integer number of frames; must be greater than 0

**Default:** 1 frame

**Example:**

```
elan-x LEC QoS Config> se ma
Maximum Burst Size in Kbps [1]? 10000
elan-x LEC QoS Config>
```

### qos-class

Sets the desired QoS Class for Data Direct VCCs. See “QoS Class (qos-class)” on page 16-4 for a more detailed description of this parameter.

**Valid Values:** 0: for Unspecified QoS Class  
1: for Specified QoS Class 1  
2: for Specified QoS Class 2  
3: for Specified QoS Class 3  
4: for Specified QoS Class 4

**Default Value:** 0 (Unspecified QoS Class)

**Example:**

```
elan-x LEC QoS Config> se qos
Desired QoS Class for Data Direct VCCs [0]? 1
elan-x LEC QoS Config>
```

### validate-pcr-of-best-effort-vccs

Use this option to enable/disable validation of the Peak Cell Rate traffic parameter of the Data Direct VCC calls received by this LE Client. See “Validate PCR of Best-Effort VCCs (validate-pcr-of-best-effort-vccs)” on page 16-5 for a more detailed description of this parameter.

**Valid Values:** YES,NO

**Default Value:** NO

**Example:**

```
elan-x LEC QoS Config> se val y
elan-x LEC QoS Config>
```

**negotiate-qos**

Use this option to enable/disable the LE Client's participation in QoS negotiation. See "Negotiate QoS (negotiate-qos)" on page 16-5 for a more detailed description of this parameter.

**Valid Values:** YES,NO

**Default Value:** NO

**Example:**

```
elan-x LEC QoS Config> se neg y
elan-x LEC QoS Config>
```

**accept-qos-parms-from-lecs**

Use this option to enable/disable the LE Client to accept/reject the QoS parameters received from an LECS as TLVs. See "Accept QoS Parms from LECS (accept-qos-parms-from-lecs)" on page 16-5 for a more detailed description of this parameter.

**Valid Values:** YES,NO

**Default Value:** YES

**Example:**

```
elan-x LEC QoS Config> se acc y
elan-x LEC QoS Config>
```

## Remove

Use the **remove** command to remove the QoS configuration of this LE Client.

**Syntax:** **remove**

**Example:**

```
elan-x LEC QoS Config> remove
WARNING: This option deletes the QoS configuration.
        To re-configure use any of the SET options.
Should the LEC QoS configuration be deleted? [No]: yes
Deleted QoS configuration successfully
elan-x LEC QoS Config>
```

## Exit

Use the **exit** command to return to the previous prompt level.

**Syntax:** **exit**

**Example 1:**

```
elan-x LEC QoS Config> exit
QoS Config>
```

**Example 2:**

```
elan-x LEC QoS Config> exit
Token Ring Forum Compliant LEC Config>
```

## ATM Interface QoS Configuration Commands

Table 16-3. LE Client Quality of Service (QoS) Configuration Command Summary

Command	Function
<b>? (Help)</b>	Displays all the ATM Interface QoS configuration commands, or displays the parameters associated with specific commands.
<b>List</b>	Lists the current ATM Interface QoS configuration.
<b>Set</b>	Sets the ATM Interface QoS parameters.
<b>Remove</b>	Removes the QoS configuration of the ATM Interface.
<b>Exit</b>	Returns to the previous prompt level.

### List

Use the **list** command to list the QoS configuration of this ATM Interface. QoS parameters are listed only if at least one parameter has been configured (see example below). Otherwise, no parameters are listed.

**Syntax: list**

**Example:**

```
ATM-I/F 0 QoS> list
```

```

      ATM Interface Quality of Service' Configuration
      =====
      (ATM interface number = 0 )

      Maximum Reserved Bandwidth for a VCC = 15000 Kbps
      VCC Type ..... = RESERVED-BANDWIDTH
      Peak Cell Rate ..... = 20000 Kbps
      Sustained Cell Rate ..... = 5000 Kbps
      QoS Class ..... = 4
      Maximum Burst Size ..... = 5 frames
ATM-I/F 0 QoS>
```

### Set

Use the **set** command to specify ATM Interface QoS parameters.

**Syntax: set**   max-reserved-bandwidth  
                   traffic-type  
                   peak-cell-rate  
                   sustained-cell-rate  
                   max-burst-size  
                   qos-class

max-reserved-bandwidth

Use this option to set the maximum reserved bandwidth allowable for each Data Direct VCC. See “Maximum Reserved Bandwidth (max-reserved-bandwidth)” on page 16-2 for a more detailed description of this parameter.

**Valid Values:** Integer in the range 0 to the line speed of ATM device in Kbps

**Default Value:** 0

**Example:**

```

ATM-I/F 0 QoS> se max-reserved-bandwidth
Maximum reserved bandwidth acceptable for a data-direct VCC (in Kbps) [0]?
15000
ATM-I/F 0 QoS>

```

### traffic-type

Sets the desired traffic for Data Direct VCCs. See “Traffic Type (traffic-type)” on page 16-3 for a more detailed description of this parameter.

**Valid Values:** BEST\_EFFORT or RESERVED\_BANDWIDTH  
**Default:** BEST EFFORT.

#### Example:

```

ATM-I/F 0 QoS> set traffic-type
Choose from:
(0): Best-Effort
(1): Reserved Bandwidth
VCC Type [0]? 0
ATM-I/F 0 QoS>

```

### peak-cell-rate

Sets the desired peak cell rate for Data Direct VCCs. See “Peak Cell Rate (peak-cell-rate)” on page 16-3 for a more detailed description of this parameter.

**Valid Values:** An integer value in the range 0 to the line speed of ATM device in Kbps

**Default Value:** Line speed of LEC ATM Device in Kbps.

#### Example:

```

ATM-I/F 0 QoS Config> set peak-cell-rate
Data-Direct VCC Peak Cell Rate in Kbps [1]? 25000
ATM-I/F 0 QoS Config>

```

### sustained-cell-rate

Sets the desired sustained cell rate for Data Direct VCCs. See “Sustained Cell Rate (sustained-cell-rate)” on page 16-3 for a more detailed description of this parameter.

**Valid Values:** An integer value in the range 0 to the minimum of max-reserved-bandwidth and peak-cell-rate; specified in Kbps

**Default Value** None

#### Example:

```

ATM-I/F 0 QoS Config> se sus
Data-Direct VCC Sustained Cell Rate in Kbps [1]? 10000
ATM-I/F 0 QoS Config>

```

### max-burst-size

Sets the desired maximum burst size in frames. See “Maximum Burst Size (max-burst-size)” on page 16-4 for a more detailed description of this parameter.

**Valid Values:** An integer number of frames; must be greater than 0

**Default:** 1 frame

#### Example:

```

ATM-I/F 0 QoS Config> se ma
Maximum Burst Size in Kbps [1]? 10000
ATM-I/F 0 QoS Config>

```

## Using and Configuring Quality of Service (QoS)

### qos-class

Sets the desired QoS Class for Data Direct VCCs. See “QoS Class (qos-class)” on page 16-4 for a more detailed description of this parameter.

**Valid Values:** 0: for Unspecified QoS Class  
1: for Specified QoS Class 1  
2: for Specified QoS Class 2  
3: for Specified QoS Class 3  
4: for Specified QoS Class 4

**Default Value:** 0 (Unspecified QoS Class)

#### Example:

```
ATM-I/F 0 QoS Config> se qos
Desired QoS Class for Data Direct VCCs [0]? 1
ATM-I/F 0 QoS Config>
```

## Remove

Use the **remove** command to remove the QoS configuration of this ATM Interface.

#### Syntax: remove Example:

```
ATM-I/F 0 QoS> remove
WARNING: This option deletes the QoS configuration.
         To re-configure use any of the SET options.
Should the ATM Interface QoS configuration be deleted? [No]: yes
Deleted QoS SRAM record successfully
ATM-I/F 0 QoS>
```

## Exit

Use the **exit** command to return to the previous prompt level.

#### Syntax: exit

##### Example 1:

```
ATM-I/F 0 QoS> exit
QoS Config>
```

##### Example 2:

```
ATM-I/F 0 QoS> exit
ATM Interface Config>
```

## Chapter 17. Monitoring Quality of Service (QoS)

This chapter describes how to monitor Quality of Service (QoS) for LAN and ELAN interfaces in the router.

It contains the following sections:

- “Accessing the QoS Console Commands”
- “Quality of Service (QoS) Console Commands”
- “LE Client QoS Console Commands” on page 17-2

### Accessing the QoS Console Commands

Use the **feature** command from the GWCON process to access the Quality of Service console commands. Enter the **feature** followed by the feature number (6) or short name (QOS). For example:

```
+feature qos
Quality of Service (QoS) - User Console
QoS+
```

Once you access the QoS console prompt, you can now select the console of a particular LE Client. To return to the GWCON prompt at any time, enter the exit command at the QoS console prompt.

Alternatively, QoS Console of an LE Client can be accessed as follows:

- At the GWCON prompt (+), enter the network command and the LE Client interface number.
- At the LE Client console prompt enter **qos-information**.

#### Example:

```
+network 3
ATM Emulated LAN Console
LEC+qos information
LE Client QoS Console
LEC 3 QoS+
```

### Quality of Service (QoS) Console Commands

This section summarizes and explains the QoS console commands. Enter these commands at the QoS+ prompt.

Table 17-1. Quality of Service (QoS) Console Command Summary

Command	Function
<b>? (Help)</b>	Displays all the QoS console commands.
<b>LE-CLIENT</b>	Gets you to the LE Client QoS console + prompt for the selected LE client.
<b>Exit</b>	Exits the QoS console process.

### LE Client QoS Console Commands

This section summarizes and explains the LE Client QoS console commands. Enter the commands from the LEC num QoS+ prompt.

Table 17-2. LE Client QoS Console Command Summary

Command	Function
<b>? (Help)</b>	Displays all the LE Client QoS console commands or displays the options associated with specific commands.
<b>List</b>	Lists the current LE Client QoS information. Options include: configuration parameters, TLVs, VCCs, and statistics.
<b>Exit</b>	Returns to the previous prompt level.

#### ? (Help)

Use the **? (help)** command to list the commands that are available from the current prompt level. You can also enter a ? after a specific command name to list its options.

**Syntax:** ?

**Example:** ?

list  
exit

#### List

Use the list command to list the QoS related information of this LE Client.

**Syntax:** list configuration-parameters  
tlv-information  
vcc-information  
data-direct-VCCs (Detailed Information)  
statistics

##### *configuration-parameters*

Lists the QoS configuration parameters. Since parameters can be configured for an LE Client, ATM Interface or the ELAN, these parameters are displayed along with resolved set of parameters which are used by the LE Client.

**le-client** The parameters configured for this LE Client which are obtained from the SRAM records. If the SRAM records contain an in-valid set of parameters then this column will not display any parameters values.

**ATM Interface** The parameters configured for the ATM Interface used by this LE Client. These parameters are obtained from the local SRAM records. If the SRAM records contain an in-valid set of parameters then this column will not display any parameter vlaues.

**From LECS** The parameters received by this LE Client from the LE Configuration Server. The parameters are received as individual TLVs in the LE\_CONFIGURE\_RESPONSE control message.

**used** The resolved set of traffic parameters which are used by for its Data Direct VCCs. If none of the entities are configured with QoS parameters then the USED parameters represent the default parameters. If parameters are configured for at least one entity, then they are resolved as follows:



- If only the LE Client or the ATM Interface is configured with parameters and either the accept-parms-from-lecs is FALSE or no parameters were received from the LECS then the configured LE Client or the ATM Interface parameters are used.
- If both the LE Client and the ATM Interface have configured parameters then the LE Client parameters are used.
- If the accept-parms-from-lecs is TRUE and parameters were received from the LECS then the LE Client parameters (or the default if the LE Client is not configured) are combined with those received from the LECS to form a complete set of the first six QoS parameters described in "QoS Configuration Parameters" on page 16-2.
- If the set of the first six QoS parameters described in "QoS Configuration Parameters" on page 16-2 contains an invalid combination then the parameters from the LECS are rejected. Note that the two flags negotiate-qos and validate-pcr-of-best-effort-vccs are validated independently.

**Example:**

LEC 1 QoS+ list configuration parameters

```

ATM LEC Configured QoS Parameters
=====

```

QoS	LEC	ATM-IF	FROM	
PARAMETER	USED	SRAM	SRAM	LECS
Max Reserved Bandwidth (cells/sec) :	23584	23584	0	none
(Kbits/sec) :	10000	10000	0	none
VCC Type .....	ResvBW	ResvBW	BstEft	0
Peak Cell Rate .....	18867	18867	365566	365566
(Kbits/sec) :	8000	8000	155000	155000
Sustained Cell Rate ...	18867	18867	365566	none
(Kbits/sec) :	8000	8000	155000	none
QoS Class .....	4	4	0	none
Max Burst Size .....	95	95	0	none
(frames) :	1	1	0	none
Validate PCR of Best-Effort VCCs . :	NO	NO	n/a	none
Enable QoS Negotiation .....	YES	YES	n/a	none
Accept QoS Parameters from LECS .. :	YES	YES	n/a	n/a

(BstEft = Best Effort, ResvBW = Reserved Bandwidth)  
(n/a = not applicable, none = no value is specified)

LEC 1 QoS+

*tlv-information*

Lists the IBM Traffic Information TLV which this LE Client registered with the LE Server. The TLV is registered only if the LE Client is participating in QoS Negotiation.

**Example:**

## Monitoring Quality of Service (QoS)

LEC 1 QoS+ list tlv

Traffic Info TLV of the LEC (registered with the LES)

```
=====
TLV Type .....= 268458498
TLV Length .....= 24
TLV Value:
  Maximum Reserved Bandwidth = 23584 cells/sec (10 Mbps)
  Data Direct VCC Type..... = RESERVED BANDWIDTH VCC
  Data Direct VCC PCR..... = 18867 cells/sec (8 Mbps)
  Data Direct VCC SCR..... = 18867 cells/sec (8 Mbps)
  Data Direct VCC QoS Class = 4
  Maximum Burst Size       = 95 cells (1 frames)
```

LEC 1 QoS+

### *vcc-information*

Lists all active VCCs of the LE Client. The information includes the traffic parameters of the connections. For BEST-EFFORT connections the Sustained Cell Rate is displayed to be the same as the Peak Cell Rate, QoS Class and the Maximum Burst Size are displayed as 0.

The Parameter Descriptor entries are:

SrcParms Parameters of a connection established by this LE Client.

DestParms Parameters of a connection received by this LE Client.

NegoParms Parameters of a connection established by the LE Client for which the QoS Negotiation was used.

RetryParms Parameters of a connection established by this LE Client after failing at least once.

### **Example:**

LEC 1 QoS+ li vcc

LEC VCC Table  
=====

Conn Index	Conn Handle	VPI	VCI	Conn Type	Status	VCC Type	PCR (kbps)	SCR (kbps)	QoS Class	Burst Size (cells)	Parameters Descriptor
2)	69	0	535	Cntrl	Ready	BstEft	155000	155000	0	0	SrcParms
3)	71	0	537	Cntrl	Ready	BstEft	0	0	0	0	DestParms
4)	72	0	538	Mcast	Ready	BstEft	155000	155000	0	0	SrcParms
5)	74	0	540	Mcast	Ready	BstEft	0	0	0	0	DestParms
6)	78	0	544	Data	Ready	ResvBW	25000	7000	1	95	DestParms

LEC 1 QoS+

### *data-direct-vccs (Detailed Information)*

This option lists the Data Direct VCC information of this LE Client. Similar information is also listed using **list vcc-information**.

### **Example:**

LEC 1 QoS+ list data direct vccs

LEC Data Direct VCCs - QoS Information  
 =====

Conn Handle = 80, VPI = 0, VCI = 546  
 Connection Type = RETRIED CONNECTION PARAMETERS  
 TrafficType = BEST EFFORT VCC  
 PCR = 58962 (25 Mbps)  
 SCR = 58962 (25 Mbps)  
 QoS Class = 0  
 Max Burst Size = 0

Conn Handle = 78, VPI = 0, VCI = 544  
 Connection Type = PARAMETERS SET BY DESTINATION  
 TrafficType = RESERVED BANDWIDTH VCC  
 PCR = 58962 (25 Mbps)  
 SCR = 16509 (7 Mbps)  
 QoS Class = 1  
 Max Burst Size = 95

LEC 1 QoS+

*statistics*

Counters are maintained for the following :

Successful QoS Connections	Number of RESERVED-BANDWIDTH connections established by the LE Client.
Successful Best-Effort Connections	Number of BEST-EFFORT connections established by the LE Client.
Failed QoS Connections	Number of RESERVED-BANDWIDTH connection requests made by the LE Client which failed.
Failed Best-Effort Connections	Number of BEST -EFFORT connection requests made by the LE Client which failed.
QoS Negotiation Applied	Number of times the QoS negotiation extension was applied. Parameters are negotiated if the LE Client receives the destination LE Client's parameters in an LE_ARP_RESPONSE control message.
PCR Proposal (IBM) Applied	Number of times the IBM Peak Cell Rate Proposal was applied. This proposal recommends using specific rate parameters if signalling at 100 Mbps or 155 Mbps for BEST-EFFORT connections. This allows other participating IBM products (eg: 25 Mbps ATM Adapters) to reject a connection based on the signalled peak cell rates.
QoS Connections Accepted	Number of RESERVED-BANDWIDTH connections accepted by this LE Client.
Best-Effort Connections Accepted	Number of BEST-EFFORT connections accepted by this LE Client.
QoS Connections Rejected	Number of RESERVED-BANDWIDTH connection requests received by this LE Client which were rejected.
Best-Effort Connections Rejected	Number of BEST-EFFORT connection requests received by this LE Client which were rejected.

## Monitoring Quality of Service (QoS)

Rejected due to PCR Validation      Number of BEST-EFFORT connections rejected by the LE Client due to validation of Peak Cell Rate when the validate-pcr-of-best-effort-vccs parameter is TRUE.

### Example:

```
LEC 1 QoS+ li stat
```

```
QoS Statistics: of Data Direct Calls Placed by the LEC
```

```
-----  
Successful QoS Connections            = 0  
Successful Best-Effort Connections   = 1  
Failed QoS Connections               = 1  
Failed Best-Effort Connections      = 1  
QoS Negotiation Applied             = 0  
PCR Proposal (IBM) Applied          = 0
```

```
QoS Statistics: of Data Direct Calls Received by the LEC
```

```
-----  
QoS Connections Accepted             = 1  
Best-Effort Connections Accepted    = 0  
QoS Connections Rejected            = 0  
Best-Effort Connections Rejected   = 0  
Rejected due to PCR Validation      = 0
```

```
LEC 1 QoS+
```

## Exit

Use the **exit** command to return to the previous prompt level.

**Syntax:**            **exit**

### Example:

```
LEC 1 QoS+ exit  
QoS+
```

---

## Part 2. ATM and LAN Emulation

<b>Chapter 18. Overview of LAN Emulation</b> .....	18-1
LAN Emulation Benefits .....	18-1
LAN Emulation Components .....	18-2
Addressing in ATM .....	18-3
ATM Addresses of LAN Emulation Components .....	18-4
Overview of Related ILMI Functions .....	18-5
Overview of the LECS Function .....	18-6
Connecting to the LES .....	18-10
Address Registration .....	18-11
Address Resolution .....	18-11
Connecting to the BUS .....	18-11
BUS Functions .....	18-12
Establishing Data Direct VCCs .....	18-13
Overview of server Extensions for LAN Emulation .....	18-13
Broadcast Manager (BCM) .....	18-14
LAN Emulation Reliability .....	18-15
LAN Emulation Security .....	18-17
BUS Monitor .....	18-18
Key Configuration Parameters for LAN Emulation .....	18-18
Super ELANs .....	18-19
<b>Chapter 19. Using and Configuring ATM</b> .....	19-1
ATM and LAN Emulation .....	19-1
How to Enter Addresses .....	19-1
Accessing the ATM Interface Configuration Process .....	19-2
ATM Configuration Commands .....	19-3
ATM Interface Commands (ATM INTERFACE> Prompt) .....	19-4
ATM Virtual Interface Concepts .....	19-9
ATM Virtual Interface Configuration Commands .....	19-11
<b>Chapter 20. Monitoring ATM</b> .....	20-1
Accessing the ATM Console Commands .....	20-1
ATM Console Commands .....	20-2
ATM Interface Console Commands (ATM INTERFACE+ Prompt) .....	20-3
<b>Chapter 21. Using and Configuring LAN Emulation Clients</b> .....	21-1
LAN Emulation Client Overview .....	21-1
Configuring LAN Emulation Clients (LE Client Config>) .....	21-2
Configuring an ATM Forum-Compliant LE Client .....	21-5
Configuring an IBM LE Client .....	21-15
<b>Chapter 22. Monitoring LAN Emulation Clients</b> .....	22-1
Accessing the LEC Console Environment .....	22-1
LEC Console Commands .....	22-2
<b>Chapter 23. Configuring LAN Emulation Services</b> .....	23-1
About LAN Emulation Services .....	23-1
Accessing the LAN Emulation Services Environment .....	23-1
Configuring a LES-BUS .....	23-4
Commands for Configuring a LECS .....	23-15

Configuring ELANs at the LECS . . . . .	23-20
Detailed Configuration of an ELAN at the LECS . . . . .	23-23
Configuring the Policies of a LECS . . . . .	23-33
Configuring Security for ELANs . . . . .	23-36
<b>Chapter 24. Monitoring LAN Emulation Services . . . . .</b>	<b>24-1</b>
Accessing the LAN Emulation Services Console Environment . . . . .	24-2
LAN Emulation Services Console Commands . . . . .	24-3
LES-BUS Console Commands . . . . .	24-6
LECS Console Commands . . . . .	24-30
LECS Policies Console Commands . . . . .	24-40
Monitoring ELANs at the LECS . . . . .	24-44
Monitoring ELAN Details at the LECS . . . . .	24-47
Security for LE Service Console Commands . . . . .	24-54

---

## Chapter 18. Overview of LAN Emulation

**Note:** See the glossary for definitions of the acronyms and terms used in this chapter.

The server implements the *LAN Emulation Over ATM: Version 1.0 Specification*, which is widely accepted as the industry standard for multivendor multiprotocol interoperability. This chapter introduces basic LAN emulation (LE) concepts in the context of the MSS implementation. It begins by examining the motivation for installing emulated LANs (ELANs).

---

### LAN Emulation Benefits

LAN emulation protocols allow ATM networks to provide the appearance of Ethernet and token-ring LANs. Although LAN emulation does not exploit all of the benefits of ATM, it is useful in migrating to ATM technology and lowering network management costs. It enables you to utilize high-speed ATM links and still protect your software and hardware investments.

Software investments are protected because application interfaces are unchanged (LAN emulation is implemented within the data link control layer, which is below the device driver interface of end stations). Hardware investments are protected with forwarding engines that bridge LAN and ATM networks so that existing adapters and wiring can continue to be used.

LAN emulation allows incremental installation of ATM adapters in stations with high-bandwidth requirements, for example, servers and engineering or multimedia workstations. Physical and logical views of a simple LAN emulation example are illustrated in Figure 18-1 on page 18-2.

## Simple LAN Emulation Network

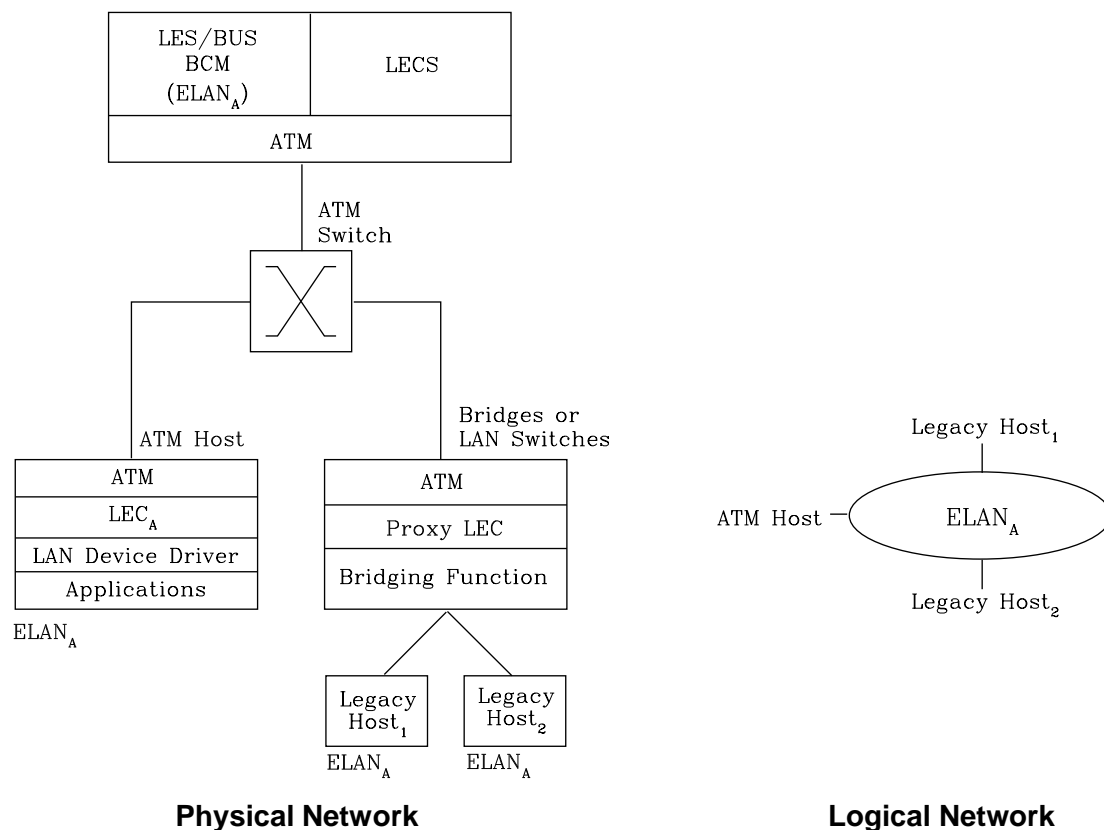

Figure 18-1. Physical and Logical Views of a Simple LAN Emulation Network

The network management benefits of emulated LANs (ELANs) come from increased flexibility in handling moves, adds, and changes. Membership in an ELAN is not based on physical location; instead, logically-related stations are grouped to form an ELAN (stations can also be members of multiple ELANs).

As long as ELAN memberships are retained, no reconfiguration is needed when stations move to new physical locations. Similarly, no wiring modifications are needed to move stations from one ELAN to another.

## LAN Emulation Components

The following components implement an ELAN:

### LAN emulation (LE) clients

LAN emulation components that represent users of the Emulated LAN.

### LE configuration server (LECS)

A LAN emulation service component that centralizes and disseminates configuration data.

### LE server (LES)

A LAN emulation service component that resolves LAN destinations to ATM addresses.



**Broadcast and Unknown Server (BUS)**

A LAN emulation service component responsible for the delivery of multicast and unknown unicast frames.

The LES, BUS, and LECS are collectively referred to as the LE service components. Each ELAN has a dedicated LES and BUS. LE clients reside in end systems, either in ATM-attached hosts or in bridges or LAN switches. The bridges or LAN switches represent hosts that are connected to Ethernet or token-ring LANs. LE clients provide a MAC-level service to higher level software. Either Ethernet IEEE 802.3 or IEEE 802.5 token-ring LANs can be emulated, but all stations on an ELAN must be of the same type.

The function that bridges between token-ring or Ethernet LAN segments and ELANs is called a Proxy LEC. To emulate a LAN, LE clients request services from the LECS, LES, and BUS. The following sections briefly review ATM addressing and pertinent Interim Local Management Interface (ILMI) functions. You need to understand these concepts before you can understand how the LE components function in the network.

---

**Addressing in ATM**

ATM uses 20-byte hierachical addressing as shown below:

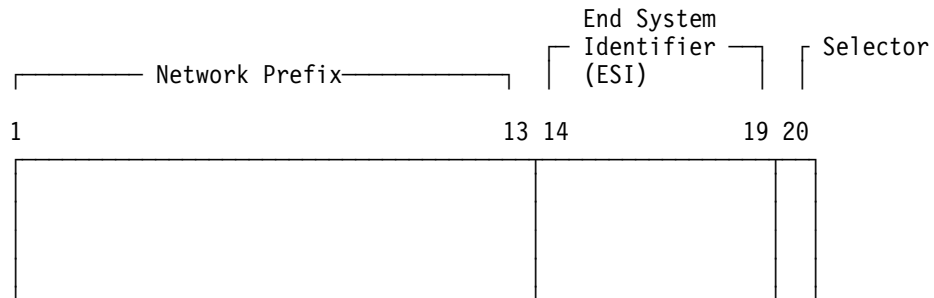

The first 13 octets of an ATM address are the Network Prefix. Each switch in your ATM network must have a unique Network Prefix. ATM switches use the Network Prefix to route VCC setup requests the destination ATM switch. End systems, like this router, retrieve their Network Prefix from their ATM switch when they activate.

Octets 14-19 of an ATM address are the End System Identifier (ESI) Each end system attached to the same switch must use a disjoint set of ESIs. When a end system activates, it attempts to register its ESIs with its ATM switch using the Interim Local Management Interface (ILMI).

ILMI defines a set of SNMP-based procedures used to manage the interface between an end system and an ATM switch. End systems use ILMI to:

- Obtain the network prefix from the switch
- Register their ESIs with the switch
- Dynamically determine the UNI version of the ATM switch
- LECs may get a list of LECS addresses from the switch

The switch forces all of its registered ESIs be unique.

Octet 20 of an ATM address is the selector

End stations obtain their Network Prefix from the switch and form their own addresses by appending an ESI and selector. These addresses must then be registered with the switch, which rejects the registration if the ATM address is not unique

### ESI

Each ATM interface on the router has a universally administered, or burned-in, MAC address. The user may use the MAC address as an ESI for some or all of the router's ATM addresses. Alternatively, the user may define up to 64 locally administered ESIs on each interface. If every end system uses its universally administered MAC address as its ESI, then ATM addresses are guaranteed to be unique. This eases the configuration burden. However, using locally administered ESIs can ease problem determination. The user may use any combination of universal or locally administered ESIs.

One way to obtain a unique ATM address is to use a burned-in IEEE MAC address as the ESI and to locally choose a unique selector. By default, the router uses the MAC address of the ATM interface as the ESI in its ATM address(es). Additional ESIs can be configured on each ATM interface.

Each ESI may have up to 255 associated selectors (0x00 through 0xff). The range of selectors is partitioned into two subranges, a configured selector range and an automatically assigned selector range. The ATM interface parameter `max-configured-selector` gives the upper bound on the configured selector range.

The ATM components on the router have various ways of choosing a selector. Some components force the user to explicitly configure a selector from the configured selector range. LES/BUSs are an example of such a component. Other components, such as Classic IP clients, allow the selector to be automatically assigned at run-time. The user does not have to choose the selector, the router does this when it activates. This selector is not guaranteed to be consistent across router restarts. Automatic selector assignment is only useful for those ATM components whose ATM address does not have to be known apriori by other network devices.

You must configure ATM before you configure emulated LANs, bridging or routing.

---

## ATM Addresses of LAN Emulation Components

In general, ATM addresses must be unique among LAN emulation components. The only exception is that a LES and BUS serving the same ELAN can share an ATM address, as is the case on the server.

LAN emulation components are configured for a particular ATM interface. You can decide to use the burned-in MAC address as the ESI portion of the ATM address of the component or you can select one of the locally-administered ESIs that have been defined for the ATM interface. Multiple LE components can share the same ESI if they have unique selectors. By default, the configuration interface assigns each LE component a unique selector value for the configured ESI; however, you can override this assignment and explicitly configure a particular selector value.

An ATM interface parameter determines the number of selectors per ESI reserved for explicit assignment. The remainder are available for dynamic assignment by the

ATM interface at run-time. LE components use only the selectors reserved for explicit assignment; by default, 200 of the 256 possible selectors per ESI are reserved for explicit assignment. Run-time selector assignment is beneficial when you do not need to control the assigned selector, for example, when you are configuring clients in Classical IP that are not paired with an ARP server.

While ATM addresses must be unique among LE components, LE components can use the same ATM addresses as non-LE components, such as Classical IP servers.

---

## Overview of Related ILMI Functions

ILMI defines a set of SNMP-based procedures used to manage the user-network interface (UNI) between an ATM end system and an ATM switch. The following three ILMI functions are particularly relevant to LAN emulation:

1. ATM address registration, which is described in “Addressing in ATM” on page 18-3
2. Dynamic determination of the signaling version being run at the switch
3. Acquisition of the LECS ATM addresses

As mentioned in “Addressing in ATM” on page 18-3, ATM address registration is a joint effort between ATM end systems and switches. ATM addresses must be registered with the switch before calls can be placed or received.

By default, the ATM interfaces of a server use ILMI procedures to query the switch MIB in an attempt to determine the signaling version (UNI 3.0 or 3.1) being run at the switch. If the query succeeds, the ATM interface runs the same UNI version as the switch; if the query fails, the ATM interface runs UNI 3.0. Alternatively, you can override the default and explicitly configure the UNI version that will run on the ATM interface.

## Manual Configuration of the Signaling Version

You need to configure the signaling version manually if the ATM switch runs UNI 3.1 and has no UNI Version MIB variable. In this case, the ATM interface cannot dynamically determine the UNI version. Because the ATM interface in the server uses UNI 3.0 by default, you should manually configure the ATM interface to use UNI 3.1.

## Locating the LECS Using ILMI

ILMI is the method of choice for locating the LECS. The ILMI MIB at the ATM switch includes a list of LECS ATM addresses that can be retrieved by LE clients. This method is useful because the LECS ATM addresses need only be configured at ATM switches, not at LE clients, and there are fewer switches than LE clients. Clients attempt to connect to the first LECS on this list. If the connection fails, they try the next LECS address in succession until a connection is established.

### Overview of the LECS Function

LE clients are not required to use the LECS, although it is recommended. If the LECS is not used, each LE client must be configured with the ATM address of the LES that serves its ELAN. The LECS reduces the network management burden by serving as a centralized repository for configuration data, minimizing configuration of the LE clients.

**Note:** At most, one LECS is configurable on each server.

Clients connect to the LECS using well-defined procedures. The following steps are attempted by a client, in order, until a virtual channel connection (VCC) to the LECS is established:

1. Connect to the LECS using any configured LECS address information (configuration of an LECS ATM address at LE clients is optional and is *not* recommended).
2. Obtain a list of LECS addresses using ILMI and attempt to connect to each LECS on the list, in order, until a VCC is established.
3. Establish a VCC to the well-known LECS ATM address as defined by the ATM Forum.

As previously stated, ILMI is the preferred method for LE clients to locate the LECS. The well-known LECS address is needed because some switches do not support the ILMI method. Configuring the LECS address at the LE clients should be done *only* when the switch does not support the ILMI method and the LE service does not support the well-known LECS address.

The server and the IBM ATM switch support all three methods: the pre-configured LECS address, ILMI connection, and the well-known LECS ATM address.

The LECS must provide initial configuration data to LE clients. The most crucial piece of data is the ATM address of the LES. To provide this information to an LE client, the LECS must be able to identify the LE client and to determine the proper LES for that LE client. The LECS identifies a LE client using information in the LE\_CONFIGURATION\_REQUEST frame sent by the LE client. The configuration request can also contain information to identify the ELAN that the LE client is seeking to join. The following information can be included in the configuration request:

1. Primary ATM address of the LE client  
This field is required and uniquely identifies the LE client.
2. LAN destination associated with the LE client  
This field can contain a MAC address or a route descriptor that uniquely identifies the LE client or it can be unspecified.
3. ELAN Name  
This field can contain a name identifying the requested ELAN or the requesting LE client. In the server implementation, ELAN names are standard ASCII strings. The ELAN name can be unspecified in the request.

#### 4. ELAN Type

This field can specify that the LE client belongs to an Ethernet or token-ring ELAN, or it can be unspecified. If the LE client specifies the type of ELAN, the LECS cannot assign the client to an ELAN of a different type.

#### 5. Maximum frame size supported by the LE client

This field can specify the upper bound on the size of a data frame that can be processed by the LE client, or it can be unspecified. The LECS cannot assign a client to an ELAN with a maximum frame size *larger* than that specified by the client. If the ELAN allows frames too large for the client to handle, the client cannot function on that ELAN.

Given this information, the LECS assigns the LE client to a LES. This is accomplished through the use of policies and policy values. A policy is a criterion that the LECS uses to make LE client-to-LES assignment decisions. A policy value is a (value, LES) pair that indicates that the specified value should be assigned to the specified LES. For example, a policy could be the MAC address of the LE client, and a policy value could be (MAC ADDR\_A, LES\_1). A LE client with MAC ADDR\_A will be assigned to LES\_1 if the LE client has not already been assigned to another LES because of a higher-priority policy. One set of policies and policy values applies to all the ELANs.

In accordance with the LE service MIB Specification of the ATM forum, these are the six policies defined:

1. ATM address
2. MAC address
3. Route descriptor
4. ELAN type
5. Max frame size
6. ELAN name

Policies also have priorities. The LECS examines policies in prioritized order. Policies with smaller values in the priority field are considered before policies with larger values in the priority field. Policies with equal values in the priority field are considered at the same time and *ANDed* together.

The LECS assigns a LE client to a LES when all of the policies at the current priority level are satisfied and in agreement. The policies are satisfied when there is a policy value that matches the corresponding field in the configuration request for each policy at the current level. The policies are in agreement when the set of matches include a LES that is common to all the policies. If these conditions are not met, the LECS considers the policies at the next priority level. If the LECS is unable to find a LES at any priority level, an unsuccessful configuration response is returned to the LE client.

To understand the meaning of agreement of the policies, consider this example of policies not in agreement. Suppose that the policies at priority one are a MAC address and an ELAN name. One of the policy values is (X'400000121225', LES\_A) and one is (ELAN 1, LES\_B). If the LE client provides a LAN destination of X'400000121225', the MAC address policy is satisfied. If the LE client provides an ELAN name of *ELAN 1*, then the ELAN name policy is also satisfied. In this case the policies at priority one are *NOT* in agreement because they refer to different LESs. In this example, the LECS would examine the policies at the next priority level.

## Overview of LAN Emulation

After determining the correct LES for an LE client, the LECS returns a configuration response to the LE client that includes the following information: LES ATM address, ELAN type, max frame size, and ELAN name. The configuration response can also include type/length/value (TLV) parameters. TLVs provide a method to download optional or user-defined parameters to the LE client.

## Sample Situations for Use of the LECS Assignment Policies

The following section offers examples of various LECS assignment policies.

### ATM Address Policy

The MSS Server LECS permits two types of ATM address policy values. The first type is a variable length ATM address prefix. For example, the policy value (399999999999990000102, LES\_A) implies that all LE clients whose ATM address begins with 399999999999990000102 should be assigned to LES\_A.

The second type of ATM address policy value is an ESI and Selector of an ATM address. For example, the policy value (10002345003281, LES\_A) implies that the LE client with an ESI of 100023450032 and a selector of 81 should be assigned to LES A.

When given the ATM address of an LE client, the LECS searches first for a matching ESI and selector. If no match is returned, the LECS searches for the ATM address prefix policy value with the longest matching prefix. Thus, for example, the above policy value value (399999999999990000, LES\_B).

ATM address ESI and selector policy values can be used to assign clients to LESs in a manner independent of the LE clients physical location (the ESI and selector is defined locally to the client). ATM address prefixes are the only policy values which indicate any geographic information.

### LAN Destination Policy

LE clients may be assigned to LESs based upon a MAC address or a route descriptor. Because a LAN destination uniquely identifies a LE client in a manner that is independent of geographic location, this policy is useful in ensuring that the LE client is assigned to the proper ELAN regardless of its physical location, for example, retaining the ELAN memberships of a workstation when it is moved from one switch to another.

### ELAN Name Policy

ELAN names are perhaps the most flexible of the assignment criteria. Some of the ways that ELAN name policy values can be used are:

- Use the actual name of the ELAN  
If LES\_A serves Elan 1, then create the policy value (Elan 1, LES\_A). LE clients specifying Elan 1 in configuration requests will then be assigned to LES\_A.

- Use aliases for the ELAN

For example, all LE clients belonging to members of the Accounting Department could be configured to use the ELAN name *Accounting*, while those belonging to the Engineering Department could use the ELAN name *Engineering*. Depending upon the number of LE clients on the ELANs, these names could be directed to the same ELAN:

Configure policy values:

(Accounting, LES\_A)  
(Engineering, LES\_A)

or to different ELANs:

Configure policy values

(Accounting, LES\_A)  
(Engineering, LES\_B)

This setup requires configuring the LE clients with the correct ELAN Name.

- Use names for the LE clients

Each LE client can be given its own name. For example, one could create the policy values (Joe, LES\_A) and (Mary, LES\_A). Then, the LE clients configured with these names would be directed to the same LES. This method requires configuring the ELAN name at each LE client and at the LECS. However, it allows Joe and Mary to move the client to a new location. Even though moving causes the client to have a new ATM address or MAC address, as long as you configure the new LE client with the same ELAN name, you retain membership in the original ELAN. This technique also offers a moderate amount of security if the names of each LE client are considered to be passwords.

### ELAN Type Policy

ELAN type policy values are most useful for providing default ELANs. For example, the following policy values would ensure that every LE client is assigned to one of the LESs:

(Token-ring ELAN Type, LES\_A)  
(Ethernet ELAN Type, LES\_B)  
(Unspecified ELAN Type, LES\_C)

In general, policies used for providing default ELAN assignments should be given a low priority, so that the more specific policies are considered first.

### Max Frame Size Policy

The max frame size policy can also be used to provide default ELAN assignments.

### Duplicate Policy Values

Duplicates occur when the same policy value is associated with multiple LESs for a given policy. Duplicate policy values are allowed for the ELAN type and max frame size policies, but are not allowed for other policies. Duplicate values are useful only when combined with a different policy of the same priority.

For example, assume that there are 3 ELANs: an Ethernet ELAN with a max frame size of 4544 bytes, a token-ring ELAN with a max frame size of 4544 bytes, and another token-ring ELAN with a max frame size of 18190 bytes. LE clients could be assigned to the appropriate ELAN by setting the ELAN type and max frame size policies to the same priority level and defining the following policy values:

(Ethernet ELAN Type, LES\_1) (Max Frame Size = 4544, LES\_1)  
(Token-Ring ELAN Type, LES\_2) (Max Frame Size = 4544, LES\_2)  
(Token-Ring ELAN Type, LES\_2) (Max Frame Size = 18190, LES\_2)

## More Information About TLVs

TLVs are defined on an ELAN basis; therefore, the same set of TLVs is returned to all LE clients that are assigned to a particular ELAN. When a TLV is included in a configuration response, the LE client **must** use the value specified in the TLV as an operating parameter (if the LE client recognizes the ELAN type). A few examples of situations where TLVs might be beneficial are as follows:

- When ELANs are spread over large geographic locations, the default timeout values for LE clients may be insufficient. These timeouts can be controlled for all LE clients by specifying their value in a TLV at the LECS.
- By default, ELANs use best effort connections to connect to the BUS. For ELANs where BUS traffic is heavy, better performance can be obtained by using reserved bandwidth connections to the BUS. The characteristics of the Multicast Send VCC between the LE client and the BUS can be controlled with TLVs.
- A TLV can be used to download the ELAN segment number to source route bridges.

In addition to fine-tuning the configuration, TLVs force all clients on the ELAN to operate with consistent parameters. The server supports all ATM Forum-defined TLVs along with arbitrary, user-defined TLVs.

---

## Connecting to the LES

After obtaining the ATM address of the LES, the LE client initiates a Control Direct VCC to the LES. When this VCC has been established, the LE client sends an LE\_JOIN\_REQUEST to the LES. The LES responds by adding the LE client to the appropriate point-to-multipoint Control Distribute VCC and returning an LE\_JOIN\_RESPONSE. By default, the LES partitions proxy and non-proxy clients onto separate Control Distribute VCCs as illustrated in Figure 18-2; however, you can configure the LES to use a single Control Distribute VCC for all LE clients in order to reduce the number of point-to-multipoint VCCs that are required. Partitioning the VCCs is generally useful because it reduces the amount of nuisance traffic that is sent to non-proxy clients. No LE\_ARP\_REQUESTs are sent to non-proxy LE clients, as described in “Address Resolution” on page 18-11.

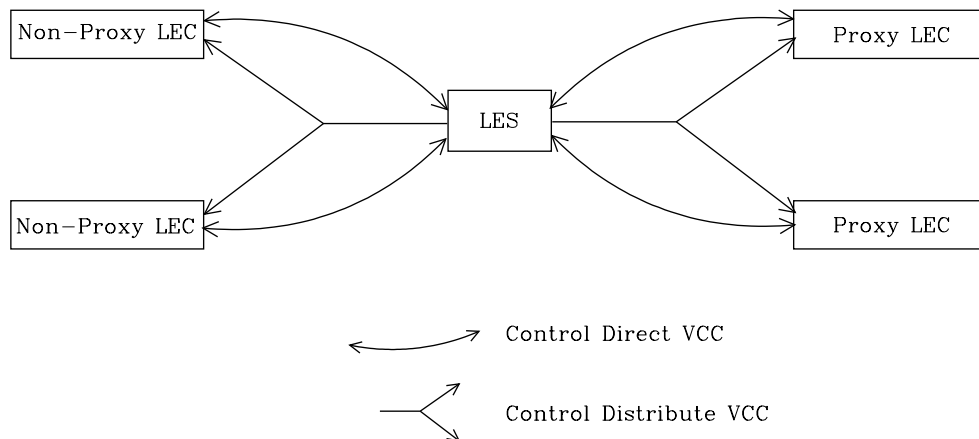

Figure 18-2. Default Connections Between LE Clients and the LES

The following ATM connections are established between the LE client and the LES:



**Control Direct VCC (bi-directional point-to-point)**

From LE client to LES

**Control Distribute VCC (point-to-multipoint)**

From LES to LE client

---

## Address Registration

LE clients register LAN destinations with the LES to ensure uniqueness and to allow the LES to answer LE\_ARP\_REQUESTs, which LE clients issue to learn the ATM address associated with a particular LAN destination. Registrations include the LAN destination and the ATM address that the LE client associates with the LAN destination. A LAN destination can be either a MAC address or a route descriptor.

Proxy LE clients do not register the MAC addresses of stations on LAN segments that they are bridging to the ELAN. On the other hand, non-proxy LE clients must register all the LAN destinations that they represent. All route descriptors must be registered, regardless of whether they are associated with a proxy or a non-proxy LE client. Route descriptors are applicable only to proxy LECs that are performing source route bridging. A route descriptor contains the bridge number of the proxy LE client and the segment number of a ring that the LE client is bridging to, that is equivalent to one hop away.

---

## Address Resolution

LAN communications are based upon source and destination MAC addresses. To enable such communication on an ATM network, MAC addresses must be resolved to ATM addresses. An LE client sends an LE\_ARP\_REQUEST to the LES to learn the ATM address of a particular LAN destination. If the LAN destination is registered, the LES responds with the ATM address associated with the LAN destination. Otherwise, the request is forwarded to all proxy LE clients on the Control Distribute VCC. There is no need to forward the request to non-proxy LECs because all of their LAN destinations are registered; however, if the LES is configured to use a single Control Distribute VCC, both proxy and non-proxy LE clients will receive the request. Control Distribute VCCs provide an efficient way for the LES to distribute control frames to multiple LE clients.

Proxy LE clients respond to LE\_ARP\_REQUESTs for unregistered MAC addresses that they represent. The LE\_ARP\_RESPONSE is sent to the LES on the Control Direct VCC, and the LES forwards the response to the LE client that issued the request.

---

## Connecting to the BUS

After connecting to the LES, an LE client issues an LE\_ARP\_REQUEST for the all 1s broadcast MAC address. The LES responds with the ATM address of the BUS. The LE client then initiates the establishment of a Multicast Send VCC to the BUS. The BUS responds by adding the LE client to the appropriate point-to-multipoint Multicast Forward VCC. By default, the BUS partitions proxy and non-proxy clients onto separate Multicast Forward VCCs; however, as was the case with the Control Distribute VCC, you can configure the BUS to use a single Multicast Forward VCC

## Overview of LAN Emulation

for all LE clients. Figure 18-3 on page 18-12 shows partitioned Multicast Forward VCCs.

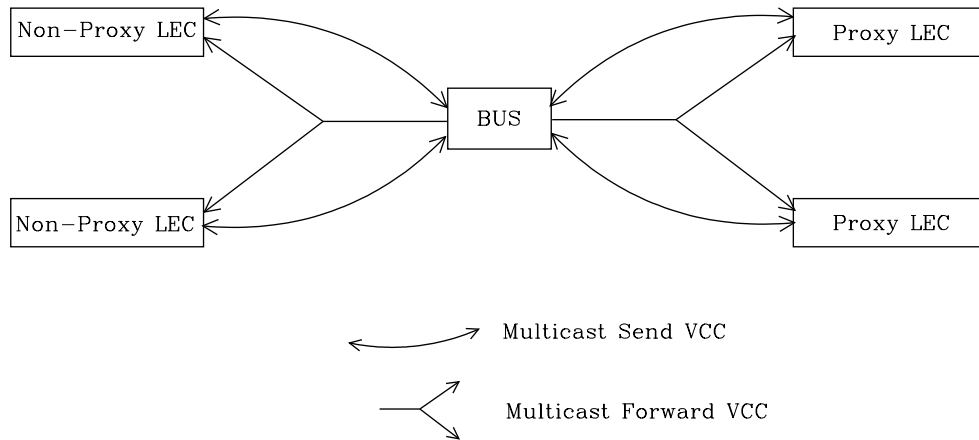

Figure 18-3. Default Connection Between LE Clients (LECs) and BUS

This list is provided to help you clarify the ATM connections that are established between the LE client and the BUS:

**Multicast Send VCC (bi-directional point-to-point)**

From LE client to BUS

**Multicast Forward VCC (point-to-multipoint)**

From BUS to LE client

---

## BUS Functions

The BUS has two basic functions:

1. Distribute multicast frames to all the LE clients in the ELAN
2. Forward unicast frames to the appropriate destinations

A LE client sends unicast frames to the BUS if it does not have a direct connection to the LE client that represents the destination. To avoid creating a bottleneck at the BUS, the rate at which an LE client can send unicast frames to the BUS is limited.

In the server implementation, the BUS has two modes of operation: partitioning the unicast frame domain and not partitioning the unicast frame domain. If you partition the unicast frame domain, the BUS uses two Multicast Forward VCCs. Otherwise, the BUS uses a single Multicast Forward VCC.

If a single Multicast Forward VCC is used, the BUS operation is very simple; all received frames are simply forwarded to all LE clients. If two Multicast Forward VCCs are used, the BUS will not broadcast unicast frames to all LE clients; instead, unicast frames destined for non-proxy LE clients will be transmitted directly to the destination LE client on a Multicast Send VCC, and all other unicast frames will be transmitted only to proxy LE clients, using the Proxy Multicast Forward VCC. When two multicast VCCs are used, the server is considered to be in intelligent BUS (IBUS) mode.

IBUS mode reduces nuisance unicast frames, which are unicast frames not destined for the client; proxy clients do not receive unicast frames destined for

non-proxy clients, and non-proxy clients never receive nuisance unicast frames. Network bandwidth devoted to nuisance frames is also reduced. On the other hand, BUS processing requirements are increased and multicast frames must be transmitted twice (once on each Multicast Forward VCC). In general, IBUS operation is recommended; however, this option should be disabled in configurations that have source route bridges that join the ELAN as non-proxies.

---

### Establishing Data Direct VCCs

Data Direct VCCs connect two LE clients, and are used to exchange unicast frames without involving the BUS. The LE client uses the address resolution procedures to determine the ATM address associated with the desired LAN destination. If the LE client already has a Data Direct VCC to the ATM address (perhaps for another LAN destination represented by the target LE client), unicast data frames are subsequently transmitted on the existing VCC; otherwise, the LE client invokes the signaling protocol to establish a new VCC.

The LE client maintains an LE\_ARP cache containing LAN destination-to-ATM address mappings. Entries in this cache are aged and must be periodically refreshed. The entries are refreshed when a data frame is received from the LAN destination. The LE client also attempts to refresh entries in the absence of data traffic.

Utilization of Data Direct VCCs is also monitored and the VCCs are released if there is no traffic for the VCC time-out period, which is configurable. Additionally, Data Direct VCCs are released in a least-recently used manner when establishment of a new Data Direct VCC fails due to insufficient resource availability.

---

### Overview of server Extensions for LAN Emulation

IBM has made value-add extensions to ATM Forum LAN Emulation available on the server. These extensions offer improved performance, reliability, security, and manageability:

#### **Broadcast Manager (BCM)**

This function can improve overall network performance by reducing ELAN broadcasts.

#### **Redundancy**

The redundancy mechanism improves reliability by allowing backup servers to take over if failures occur at primary servers.

#### **Security**

Security is improved by letting the LECS control ELAN memberships.

#### **BUS Monitor**

This function enhances manageability by identifying the top users of the BUS.

The following four sections describe each of these extensions.

---

### Broadcast Manager (BCM)

BCM is an extension to LAN emulation that consists of IBM enhancement of the LAN emulation BUS. Without BCM, the following events occur:

- A multicast frame sent to the BUS is forwarded to all LE clients on the ELAN.
- LE clients that include the proxy function to provide bridging support forward the broadcast frame onto other LAN segments.
- All end stations receive and process every broadcast frame.

BCM can be enabled on individual ELANs for any of these protocols:

- IP
- IPX
- NetBIOS

When BCM is enabled, a minimal amount of layer 2 and layer 3 information is decoded for specific types of broadcast frames sent to the BUS. Whenever possible, BCM transforms broadcast frames into unicast frames, and sends them only to interested LE clients and end stations. BCM reduces both network traffic and associated end-station overhead by filtering nuisance broadcast frames. These functions can improve overall system performance and enable practical deployment of larger ELANs.

### BCM Support for IP

When enabled for IP, BCM scans all IP ARP requests and replies to learn the location of IP addresses in the IP subnet that contains this ELAN. The objective is for BCM to take each broadcast ARP request frame and forward it as a unicast frame directly to the LE client representing the target IP station. Both network traffic and end-station processing time are reduced when the request is forwarded directly to the appropriate LE client on the Multicast Send VCC instead of being broadcast to all LE clients on the Multicast Forward VCCs. When the destination station is located behind a bridge function, the LAN that the destination station belongs to also benefits from the reduced broadcast traffic.

### BCM Support for IPX

For IPX, BCM limits the scope of advertisement broadcasts. IPX routers and servers periodically broadcast their known network and service information. Generally, these broadcasts, called Routing Information Protocol (RIP) and Service Advertising Protocol (SAP) general response packets, need to be received only by other IPX routers and servers.

When it is enabled for IPX, BCM dynamically identifies the set of IPX routers and servers based on advertisement transmissions, and only forwards RIP and SAP advertisements to other IPX routers and servers.

With BCM enabled, any quiet device (that is, a device that does not transmit IPX advertisements) that needs to receive IPX advertisements has to be configured as a static target. An example of such a device is a station running software that discovers the IPX network topology by monitoring IPX advertisements.

## BCM Support for NetBIOS

NetBIOS is considered to be a broadcast-abusive protocol and therefore an excellent candidate for BCM. NetBIOS communication is based on names. Transmitting stations can learn the MAC address associated with a particular destination name by broadcasting a query or by having the frame multicasted to the NetBIOS functional address. In the latter case, every NetBIOS device in the network must receive the frame and determine whether the destination name on the frame applies to itself. To make things even worse, NetBIOS devices tend to repeat transmission of certain types of frames as much as 10 times. Historically, this was to ensure that all devices receive the frame in cases where the network is heavily congested.

The BCM strategy is to associate unique NetBIOS names with MAC addresses and LE clients by learning names from NetBIOS frames sent to the BUS. After a unique NetBIOS name is learned, subsequent NetBIOS broadcast frames destined for that name are forwarded to a single LE client as a unicast frame. BCM also filters certain NetBIOS frames that are broadcast repeatedly.

## BCM Support for Source Route Bridging

Source Route Management (SRM) is an additional BCM feature that can be configured for 802.5 ELANs. When enabled, this feature will further process frames managed by BCM and, whenever possible, transform All Routes Explorer (ARE) or Spanning Tree Explorer (STE) frames into Specifically Routed Frames (SRF). Once a frame is transformed into a SRF, the frame no longer needs to be transmitted onto each ring in the bridged network.

The token-ring topology behind each LE client is learned by recording the routing information field (RIF) of frames received by the BUS. Because SRM dynamically learns token-ring topology information, an aging mechanism is used to remove information that has not been refreshed recently.

To decide whether to enable BCM or SRM (or both), you should compare the net system-wide benefit with the inevitable reduction in the rate at which packets are forwarded when BCM or SRM is enabled.

**Note:** Broadcast Manager and Source Route Management are unavailable and cannot be enabled if **bus-mode** is set to *adapter*.

---

## LAN Emulation Reliability

A perceived lack of robustness has been one of the most widely proclaimed criticisms of LAN emulation. While the ATM Forum is addressing this issue with specifications for distributing the LE service, the server offers an answer in the interim. Figure 18-4 on page 18-16 provides a framework for describing the MSS solution.

## Overview of LAN Emulation

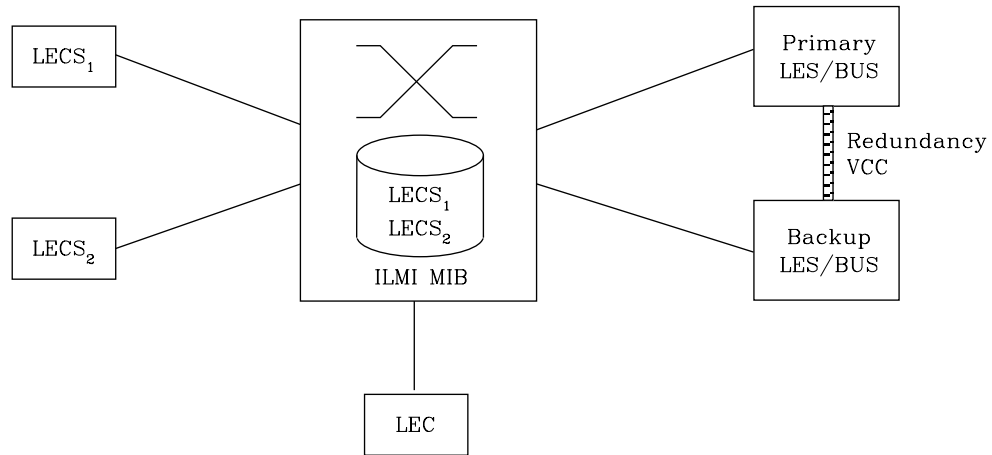

Figure 18-4. LAN Emulation Redundancy

Each LES/BUS may be independently configured for redundancy (the default is no redundancy). If redundancy is enabled, the LES/BUS is configured to assume the role of a primary or a backup LES/BUS. Unless it has been configured as a redundant LES/BUS, the LES/BUS is primary. The primary LES/BUS is typically the only LES/BUS visible to the LE clients. It is responsible for setting up and maintaining a Redundancy VCC to the backup LES. The presence of this VCC indicates that the primary LES/BUS is operational. The backup LES will not accept Control Direct VCC calls while the Redundancy VCC is established. However, if the Redundancy VCC is **not** present, the backup LES/BUS services ELAN requests in the usual manner.

For the redundancy protocol to be effective, LE clients must detect the failure of the primary LES/BUS and connect to the backup. LE clients detect server failures by means of released VCCs. Connection to the backup LES/BUS is accomplished through the LECS.

Upon receiving an LE\_CONFIGURE\_REQUEST, the LECS assigns the LE client to the appropriate LES and ELAN. If this LES has no configured backup, then the LECS returns the ATM address of the LES. If the LES is configured with a backup LES, then the LECS may return the primary or backup LES address. The backup LES address is returned if the backup LES exists on the same MSS Server as the LECS and is currently serving the ELAN, if the primary LES exists on the same MSS Server as the LECS and it is not currently serving the ELAN, or if neither LES exists on the same MSS Server as the LECS and the client was assigned to last assigned to the primary LES (within the past 5 minutes). Otherwise, the primary LES address is returned to the LE client.

The LECS retains a short-term memory of all client assignments so that it may alternately direct a LE client to a primary and backup LES. This simple heuristic makes the correct assignment in the nominal case of no failure and is self-correcting. At worst, the heuristic causes the LE client to repeat the configuration phase of joining an ELAN.

LECS robustness can be achieved by establishing duplicate LECSs on multiple platforms and including their ATM addresses in the ILMI database. LE clients will then connect to the backup LECS if the primary is unavailable. For example, LECS 1 and the backup LES/BUS in Figure 18-4 could be on MSS Server 1, while LECS 2 and the primary LES/BUS could be on MSS Server 2.

Additionally, note that servers need not be dedicated to backup functions, because a single server can host backup LES/BUSs for some ELANs and primary LES/BUSs for other ELANs.

---

## LAN Emulation Security

Traditional LANs offer security in the sense that a physical connection implies that two stations are on the same LAN. Because multiple emulated LANs can exist on a single ATM network, stations that are not on the ELAN can be physically connected to stations that are on the ELAN. This situation presents a security risk in that unauthorized stations can connect to the LES and attempt to use its services.

To control ELAN membership, an MSS LES can be configured to validate LE\_JOIN\_REQUESTs with the LECS. In this mode the LES forms an LE\_CONFIGURE\_REQUEST on behalf of the LE client using information from the LE\_JOIN\_REQUEST. These LE\_CONFIGURE\_REQUESTs include the source LAN destination, Source ATM address, ELAN type, max frame size, and ELAN name from the LE\_JOIN\_REQUEST, along with an IBM Security TLV. The security requests are transmitted to the LECS by a multiplexing component called the LECS interface, and the LECS must validate the requests using its ELAN assignment database before LE clients are allowed to join the ELAN.

A LECS interface is associated with an ATM interface, and all LESs configured on the ATM interface use the same LECS interface. The LECS interface conserves VCC resources by multiplexing security requests from multiple LESs onto a single VCC to the LECS. The LECS interface locates the LECS dynamically using the ILMI and well-known LECS address mechanisms. After the VCC to the LECS is established, the LECS interface issues a local query to determine whether the LECS is located on the same server. If the LECS is located on the same server, a local interface is used to confirm requests to join without transmitting requests onto the ATM network.

To maximize the security of an ELAN, the following steps are recommended:

1. At the LECS, use ATM addresses to assign clients to the LES. See "Overview of the LECS Function" on page 18-6 for more information.
2. Activate the LECS Interface on the server.
3. Activate the security option of the LESs.
4. Use *Address Screening* at the ATM switches. This option causes switches to validate that calling stations use their actual ATM addresses in the call setup. Thus, stations cannot impersonate other stations.

These steps ensure that stations are correctly identified and that only authorized stations join the ELAN.

### BUS Monitor

The BUS Monitor provides a way to pinpoint end users that can be over-utilizing the BUS. When enabled, the BUS Monitor periodically samples the traffic sent to the BUS on a particular ELAN. At the end of each sample interval, the BUS Monitor identifies the top users of the BUS by their source MAC addresses, LE client ATM addresses, and the number of sampled frames each of them has sent to the BUS. You can configure the following parameters for the BUS monitor:

- The number of MAC addresses (hosts) to record as top users
- The number of seconds in each sample interval
- The sample rate. The sample rate consists of the fraction of all the frames received that the sample consists of, for example, 1 out of every 100 frames, 1 out of every 10 frames, or every frame.
- The number of minutes between sample intervals

---

### Key Configuration Parameters for LAN Emulation

This section briefly describes the required configuration parameters of the server LAN emulation components. The ATM interface for the LAN emulation components must be defined before the components can be created.

#### 1. LEC:

To create a LE client, the user only needs to specify the ELAN type. If two LE clients are defined on a single ATM interface and are bridged together, then one of the LE clients must use a non-default MAC address. By default, LE clients use the burned-in MAC address of the ATM interface. The default maximum frame size is 1516 bytes for Ethernet LE clients and 4544 bytes for token-ring LE clients.

#### 2. LES/BUS:

The required parameters for a LES/BUS are the ELAN name, the ELAN type, and the ESI (which is selected from a list that includes the burned-in MAC address and any locally-administered values defined for the ATM interface). Defaults are supplied for other parameters.

The maximum frame size default is 1516 bytes for Ethernet ELANs and 4544 bytes for token-ring ELANs. LE clients will not be allowed to join the ELAN if their maximum frame size is less than the maximum frame size of the ELAN; LE clients that have a larger maximum frame size will be allowed to join the ELAN, but will use the maximum frame size of the ELAN as a result of join-time negotiation with the LES.

#### 3. LECS:

At a minimum, the LECS ESI must be selected and a default ELAN assignment policy must be configured. See "Overview of the LECS Function" on page 18-6 for more information.



---

## Super ELANs

A Super ELAN is a collection of emulated LANs. A client on any of the Super ELAN member emulated LANs may set up a data direct VCC to any other client on the super ELAN. In essence, a super ELAN emulated a standard ELAN, distributing the LE services among the member ELANs. The reliability and performance of the LE services increases with the number of ELANs. Resource utilization becomes less centralized, allowing for a much larger super ELAN than a standard ELAN.

Super ELAN is essentially the precursor to LAN Emulation Network to Network (LNNI) specification currently being addressed by the ATM Forum LAN Emulation standards committee. Super ELAN provides distributed LE services for version 1.0 emulated LANs.

Distributing LE services is accomplished by logically linking together individual ELANs. When ELANs are linked together in a super ELAN, certain LAN Emulation Control frames (such as LE ARP requests and LE ARP responses) and data frames are forwarded between the member ELANs. By forwarding certain LE Control frames, clients are able to locate a target client on another ELAN and establish a data direct VCC to it.

Data Direct VCCs between ELANs also utilize the switched fabric of the ATM network. Although each LE server still exhibits a concentration of utilization, no single LE server serves the entire Super ELAN, and network utilization is distributed among the constituent LE servers. Thus, Super ELAN LE Services can serve larger numbers of clients.

Since a Super ELAN is made up of multiple ELANs, reliability is improved. If one LE server fails, other LE servers within the Super ELAN are not affected. Only the inter-ELAN data direct VCCs to clients in the failed ELAN are affected. In addition, clients that were joined to the failed ELAN may be configured to join one of the other Super ELAN LE services by requesting another LES address from the LECS.

The propagation of broadcast and unknown frames is a major concern within a Super ELAN network. Both types of frames are forwarded to every member ELAN except the ELAN from which the frames were received. This forwarding uses bandwidth on every segment of the network, and, in the case of broadcast frames, causes an interruption at every station.

A superELAN is equipped with two additional functions to combat the effects of these frames.

Bridging Broadcast Manager (BBCM) can transform many broadcast frames into unicast frames, thus lessening their effects on network performance. BBCM snoops on packets to learn bindings between layer 3 and layer 2 network addresses. Future broadcast packets to any learned layer 3 address can be transformed into unicast packets and forwarded by the bridge as any other unicast packet. If the transformed unicast address is in the bridge database, then the packet can be forwarded to its destination segment. The packet will not cause an interruption at every station, nor will it utilize bandwidth on every network segment.

Dynamic Protocol Filtering (DPF) also snoops on packets. It learns the different protocols being received on every bridge port. Packets for a particular protocol are

## Overview of LAN Emulation

not forwarded over ports which are not actively using that protocol. Although many bridges permit filtering based on protocol, DPF performs this filtering automatically based on current traffic.

Super ELAN, aided by Bridging Broadcast Manager and Dynamic Protocol Filtering, combine to provide a reliable, distributed, emulated LAN with strong controls on the propagation of broadcast and unknown frames.

Refer to the *Multiprotocol Switched Services (MSS) Server Command Line Interface Volume 2* chapter on Configuring Bridging.

## Bridging Broadcast Manager

Broadcast frames are especially harmful in bridged environments because every broadcast frame is transmitted on every LAN segment. This causes an interruption at each station on the bridged LAN, consumes precious network bandwidth, and uses processing cycles at each bridge.

Many broadcast frames are destined for all stations only because the source station does not know the destination MAC address. Examples of such frames are IP ARP requests and NetBIOS NAME\_QUERY commands. In these examples, the source station is trying to find a specific higher level entity on top of some unknown MAC layer. Since the destination MAC layer is unknown, all stations are interrupted and queried for the entity. Most stations discard the request because it does not pertain to them, and only one station replies to the query.

Bridging Broadcast Manager (BBCM) can transform many IP and NetBIOS query broadcast frames into unicast frames. Since the transformed unicast address is likely in the bridge database, the packet can be forwarded to only the intended destination segment.

Refer to the *Multiprotocol Switched Services (MSS) Server Command Line Interface Volume 2* chapter on Configuring Bridging.

## Dynamic Protocol Filtering (VLANs)

Dynamic Protocol Filtering (DPF) is a method by which the bridged network may be partitioned into several protocol-specific Virtual LANs, or protocol vlans. Its purpose is to limit the proliferation of frames that are normally forwarded over all active spanning tree ports. DPF dynamically activates filters based upon the traffic on each bridge port. The bridged network can thus be dynamically partitioned into protocol-specific subnetworks.

DPF monitors traffic on each bridge port, learning the identity of protocols and subnets being used on each port. DPF manages the forwarding domains for each vlan by forwarding broadcast and multicast frames for vlans only on ports that are in the forwarding domain of that vlan.

DPF and BBCM each reduce the unnecessary propagation of certain frames. BBCM operates by transforming broadcast frames into unicast frames. DPF operates by forwarding broadcast frames to selected ports based on the forwarding domain of a vlan. In both cases, unnecessary network utilization is decreased because frames are forwarded on fewer bridge ports. Also, stations are interrupted less frequently because broadcast and multicast transmissions now traverse only a portion of the bridged network.

DPF offers further benefits to increase performance, enhance security and facilitate moves and changes in the network.

For subnetted IP networks, DPF has an *IP-cut-through* facility that allows establishment of data-direct VCCs between IP workstations on different IP subnet vlans. By enabling *IP-cut-through* and shortening the IP subnet mask in end-stations, the end-stations communicate directly with each other without involving an IP router. This significantly increases IP throughput in the network, reduces IP routing requirements, and isolates IP subnet broadcast traffic.

*IP-cut-through* can be enabled or disabled by an IP subnet or IP end-station. *IP-cut-through* can also be configured to allow cut-through in one direction but force a routed path in the reverse direction. This uni-directional cut-through can be used to force IP clients to go through an IP router for security but allow IP servers to "cut through" to the clients for maximum performance.

DPF also allows the user to explicitly include or exclude a vlan on specific bridge ports. Explicit inclusion creates one or more default vlans for a port. Normally, membership in DPF forwarding domains is based on traffic seen on the ports. Explicit inclusion could be used on ports if the devices attached to that port are silent devices (for example, network printers) that would never be detected. Explicit exclusion enhances security by allowing for the isolation of selected ports.

Since DPF automatically adjusts the forwarding domain of a vlan based on traffic, it lets users move around the network without any changes to their configuration. This is especially useful for IP networks, because it eliminates the need for assigning new IP addresses when users move.

DPF is a bridging enhancement and applies in a bridged environment. All ports within the bridge environment must be the same type (either Ethernet or Token-Ring). Vlans can be configured for multiple IP subnets, multiple IPX networks, and a single NetBIOS network.

Refer to the *Multiprotocol Switched Services (MSS) Server Command Line Interface Volume 2* chapter on Configuring Bridging for additional information.

## Overview of LAN Emulation

---

## Chapter 19. Using and Configuring ATM

This chapter describes how to configure the ATM interface. It includes the following sections:

- “ATM and LAN Emulation”
- “Accessing the ATM Interface Configuration Process” on page 19-2
- “ATM Configuration Commands” on page 19-3
- “ATM Virtual Interface Concepts” on page 19-9
- “ATM Virtual Interface Configuration Commands” on page 19-11

---

### ATM and LAN Emulation

LAN emulation provides support for virtual Token-Ring and Ethernet LANs over an ATM network. Refer to “Addressing in ATM” on page 18-3 for a discussion of ATM addressing.

---

### How to Enter Addresses

Addresses are entered in two ways, depending upon whether the address represents (1) an IP address, or (2) an ATM address, MAC address, or route descriptor, as follows:

1. IP address

IP addresses are entered in dotted decimal format, a four-byte field represented by four decimal numbers (0 to 255) separated by periods (.).

**Example of IP Address:**

01.255.01.00

2. ATM or MAC address or route descriptor

ATM addresses, MAC addresses, and route descriptors are entered as strings of hexadecimal characters with or without optional separator characters between bytes. Valid separator characters are dashes (–), periods (.), or colons (:).

**Examples of ATM address, MAC address or route descriptor:**

A1FF010203  
or  
A1–FF–01–02–03  
or  
A1.FF.01.02.03  
or  
39.84.0F.00.00.00.00.00.00.00.00.00.03.10.00.5A.00.DE.AD.08  
or  
A1:FF:01:02:03  
or even  
A1–FF.01:0203

Each type of address requires a different number of hexadecimal characters:

<b>ATM</b>	40
<b>MAC</b>	12
<b>ESI</b>	12
<b>Route descriptor</b>	4

## Accessing the ATM Interface Configuration Process

This information applies to addresses entered for ATM; LAN emulation; Classical IP and ARP over ATM; and IPX and ARP over ATM.

---

## Accessing the ATM Interface Configuration Process

Use the following procedure to access the configuration process.

1. At the OPCON prompt, enter **talk 6**. (For more detail on this command, refer to Chapter 5, "The OPCON Process and Commands.") For example:

```
* talk 6
Config>
```

After you enter the **talk 6** command, the CONFIG prompt (Config>) displays on the console. If the prompt does not appear when you first enter configuration, press **Return** again.

2. At the CONFIG prompt, enter the **list devices** command to display the network interface numbers for which the router is currently configured.
3. Record the interface numbers. If ATM is not specified as an interface, then create a ATM interface by using the **add device** command at the Config> prompt. If ATM is not specified as an interface, enter the **add device atm** command.

```
Config> add dev atm
Device Slot x(0-3) 0?
Adding CHARM ATM Adapter device in slot 0 port 1 as interface xx
(where x is the interface number assigned)
```

**Note:** Two ATM interfaces may be defined.

4. Enter the **network** command and the number of the ATM interface you want to configure. For example:

```
Config> network 0
ATM Config>
```

The ATM configuration prompt (ATM Config>), is displayed.

## ATM Configuration Commands

This section summarizes the ATM configuration commands. Enter the commands at the ATM config> prompt.

Table 19-1. ATM Configuration Command Summary

Command	Function
<b>? (Help)</b>	Lists all of the ATM configuration commands, or lists the options associated with specific commands.
<b>INTERFACE</b>	Gets you to the ATM Interface Config> prompt from which you can list, change, or configure the ATM Interface. <ul style="list-style-type: none"> <li>• Add an ESI.</li> <li>• List the current configuration or list ESIs.</li> <li>• Remove an ESI.</li> <li>• Set parameters of the ATM network.</li> <li>• Enable or disable an ESI.</li> <li>• Exit</li> </ul>
<b>LE-SERVICES</b>	Gets you to the LE Services Config> prompt from which you can list, change, or configure LAN Emulation Services as described in Chapter 23, “Configuring LAN Emulation Services” on page 23-1. <ul style="list-style-type: none"> <li>• LECS gets you to the LECS Config&gt; prompt from which you can configure a LAN Emulation Configuration Server.</li> <li>• LES-BUS gets you to the LES-BUS config for ELAN 'x'&gt; prompt from which you can configure a LAN Emulation Server — Broadcast and Unknown Server (LES-BUS).</li> <li>• List all LES-BUS names.</li> <li>• SECURITY (LES/LECS INTERFACE TO VALIDATE JOINS) gets you to the LECS Interface Config&gt; prompt from which you can list, change, or configure security between the LECS and LES-BUS pairs.</li> </ul>
<b>LE-CLIENT</b>	Gets you to the LE Client Config> prompt from which you can list, change, or configure the LAN Emulation Client Interface as described in Chapter 21, “Using and Configuring LAN Emulation Clients” on page 21-1. <ul style="list-style-type: none"> <li>• Add a LAN Emulation Client (LEC) for a token-ring or Ethernet emulated LAN.</li> <li>• Configure a network by network #. This command takes you to the LE Config&gt; prompt, from which you can configure a specific LAN Emulation Client (LEC).</li> <li>• List LAN Emulation Clients (LECs).</li> <li>• Remove a LAN Emulation Client (LEC).</li> </ul>
<b>VIRTUAL ATM</b>	Gets you to the ATM Virtual Interface Config prompt from which you can list, add, or remove the ATM Virtual Interface as described in “ATM Virtual Interface Configuration Commands” on page 19-11.
<b>Exit</b>	Exit the ATM Configuration process and returns to the Config> prompt.

### ATM Interface Commands (ATM INTERFACE> Prompt)

This section summarizes and then explains the commands for configuring a specific ATM interface.

Enter the commands at the ATM INTERFACE> prompt.

*Table 19-2. ATM INTERFACE Configuration Command Summary*

Command	Function
<b>? (Help)</b>	Lists all the ATM Interface configuration commands, or lists the options associated with specific commands.
<b>Add</b>	Adds an ESI.
<b>List</b>	Lists the current configuration or list ESIs.
<b>QoS</b>	Gets you to the ATM I/F 0 QoS Config> prompt from which you can configure Quality of Service as described in “ATM Interface QoS Configuration Commands” on page 16-12.
<b>Remove</b>	Removes an ESI.
<b>Set</b>	Sets parameters of the ATM network.
<b>Disable</b>	Disables an ESI.
<b>Enable</b>	Enables an ESI.
<b>Exit</b>	Returns to the ATM Config> prompt.

### Add

Use the **add** command to add an ESI to your ATM configuration.

Octets 14-19 of an ATM address are the End System Identifier (ESI). Each end system attached to the same switch must use a disjoint set of ESIs. When an end system activates, it attempts to register its ESIs with its ATM switch using ILMI. The switch forces all of its registered ESIs be unique.

**Syntax:** `add esi esi-address`

`esi esi-address`

Address of End System Identifier.

**Valid Values:** Any 12 hexadecimal digits

**Default Value:** none

ATM INTERFACE> `add esi 014617183763`

### List

Use the **list** command to list the configuration of this ATM device or to list the set of configured ESIs.

**Syntax:** `list configuration`

`esi`

`configuration`

Lists the ATM device configuration. For an explanation of the listed fields, see “Set” on page 19-5.

**Example:** `list`



## ATM Configuration

```

Interface (net) number = 0
Maximum VCC data rate Mbps = 155
Maximum frame size = 9234
Maximum number of callers = 209
Maximum number of calls = 1024
Maximum number of parties to a multipoint call = 512
Maximum number of Selectors that can be configured = 200
UNI Version = UNI 3.0
Packet trace = OFF

```

## ESIs

Lists the ESIs in the ATM configuration.

**Example: list esi**

```
ATM INTERFACE> list esi
```

ESI	Enabled
000000000009	YES
0000000000100	YES

**QoS Configuration**

Use the **qos-configuration** command to get you to the ATM I/F 0 QoS Config> prompt from which you can configure Quality of Service as described in “ATM Interface QoS Configuration Commands” on page 16-12.

**Remove**

Use the **remove** command to remove an ESI from your ATM configuration. All ATM components using this ESI should be reconfigured to use a different ESI. An ATM component which attempts to use a removed ESI will not activate on the next router restart.

**Syntax:** `remove esi esi-address`

`esi esi-address`

Address of End System Identifier.

**Valid Values:** Any 12 hexadecimal digits

**Default Value:** none

**Set**

Use the **set** command to specify ATM network parameters.

**Syntax:** `set` max-data-rate  
max-frame  
max-config-selectors  
max-calls  
max-callers  
max-mp-parties  
trace  
uni-version

`max-data-rate`

Sets the default and upper bound for VCC traffic parameters of most LANE and CIP connections. For example, this is the default PCR for best-effort VCCs initiated by LE Clients. Signalled SCRs and PCRs cannot exceed this

limit. The default value should be satisfactory in most situations. An example of a situation where it is beneficial to change this value would be if the majority of the stations use 25 Mbps adapters. In this case, it may be desirable to limit the data rate on VCCs to 25 Mbps so that the lower speed stations are not overwhelmed with frames from the router. The units for this parameter are Mbps.

**Valid Values:** 25 (Mbps)  
100 (Mbps)  
155 (Mbps)  
**Default Value:** 155 (Mbps)

**Example: set speed**

```
ATM INTERFACE> set speed 155
```

### max-calls

Sets the maximum number of switched virtual circuits (SVCs) that can exist on this ATM device. Every point-to-point and point-to-multipoint SVC uses system resources. This parameter helps limit the system resources reserved for signalling and switched connections. Increasing this parameter will allow more simultaneous SVCs. However, more system memory for managing these connections will be required.

**Valid Values:** An integer in the range of 64 - 65535  
**Default Value:** 1024

**Example: set max-calls**

```
ATM INTERFACE> set max-calls 500
```

### max-callers

Sets the maximum number of entities on the router that use the ATM interface. Each LEC, LES/BUS, LECS, LECS Interface, Classical IP Client, and 1483 bridge interface qualifies as a user of the ATM interface. Increasing this parameter allows more users of the interface and uses more system memory.

**Valid Values:** An integer in the range of 64 - 1024  
**Default Value:** 209

**Example: set max-callers**

```
ATM INTERFACE> set max-callers 25
```

### max-config-selectors

Sets the maximum number of selectors under your specific control.

The selector is used to distinguish different users on the same end system. VCC setup requests are routed in the following heirarchical fashion: ATM switches route to the destination ATM switch using the Network Prefix, the destination ATM switch routes to the destination end system using the ESI, and the end system notifies the destination user based on the selector.

Each ESI may have up to 255 associated selectors (0x00 through 0xff). The range of selectors is partitioned into two subranges, a configured selector range and an automatically assigned selector range. The ATM interface parameter max-configured-selector gives the upper bound on the configured selector range.

The ATM components on the router have various ways of choosing a selector. Some components force the user to explicitly configure a selector from the configured selector range. LES/BUSs are an example of such a

component. Other components, such as Classic IP clients, allow the selector to be automatically assigned at run-time. The user does not have to choose the selector, the router does this when it activates. This selector is not guaranteed to be consistent across router restarts. Automatic selector assignment is only useful for those ATM components whose ATM address does not have to be known apriori by other network devices.

The relative sizes of the selector range can be modified to conform to the types and numbers of ATM users on the router.

**Valid Values:** 0 - 255 (0x00 - 0xFF)

**Default Value:** 200

**Note:** The selector is byte 20 of a 20-byte ATM address.

**Example:** `set max-config-selectors`

```
ATM INTERFACE> set max-config-selectors 225
```

#### max-frame

Sets the maximum number of octets permitted in any data frame sent or received on the ATM interface. System memory is allocated based upon this parameter. Increasing the max-frame requires more system memory, but allows processing of larger frames.

All router entities using the ATM interface must use a maximum frame size less than or equal to the max-frame-size of the ATM interface. This includes all LECs, CIP clients, and 1483 bridge interfaces.

**Valid Values:** An integer in the range of 16 - 65535

**Default Value:** 9234

**Example:** `max-frame`

```
ATM INTERFACE> set max-frame 1000
```

#### max-mp-parties

Sets the maximum number of leaves on a point-to-multipoint connection initiated by the router. This parameter affects system memory allocation. Increasing this value is necessary if the router must set up point-to-multipoint connection(s) to a large number of destinations.

**Valid Values:** An integer in the range of 1 - 5000

**Default Value:** 512

**Example:** `max-mp-parties`

```
ATM INTERFACE> set max-mp-parties 300
```

**Valid Values:** 155 (Mbps)

**Default Value:** 155 (Mbps)

**Example:** `set speed`

```
ATM INTERFACE> set speed 155
```

#### trace

Sets the packet tracing parameters on the interface. Packet tracing can be enabled or disabled on a range of VPI/VCI values. Common VPI/VCI values to trace are:

- 0/5 for signalling packets
- 0/16 for ILMI packets.

**Valid Values:** [ON|OFF]

**Default Value:** ON

## ATM Interface Commands

You are prompted for the VPI/VCI range you want to trace.

**Beginning VPI Valid Values:** 0 - 255

**Default Value:** 0

**Ending VPI Valid Values:** 0 - 255

**Default Value:** 255

**Beginning VCI Valid Values:** 0 - 65535

**Default Value:** 0

**Ending VCI Valid Values:** 0 - 65535

**Default Value:** 65535

**Example: set trace on**

```
ATM INTERFACE> set trace on | off [:]? on
beginning of VPI range [0]? 0
end of VPI range [255]? 0
beginning of VCI range [0]? 5
end of VCI range [65535]? 5
```

**uni-version**

Sets the User Network Interface (UNI) version used by the ATM interface with communicating with the attached ATM switch. The UNI versions used by the ATM interface and by the ATM switch must match. If the UNI version is configured as AUTO, the ATM device attempts to learn the UNI version to use from the switch.

**Valid Values:** [UNI 3.0|UNI 3.1|AUTO-DETECT|None]

**Default Value:** UNI 3.0

**Note:** Must match the ATM switch.

**Example: set uni-version**

```
ATM INTERFACE> set uni-version 3.0
```

## Enable

Use the **enable** command to enable an ESI in the configuration of your ATM device. The ATM interface attempts to register only enabled ESIs when it activates.

**Syntax:** `enable esi esi-address`

`esi esi-address`

Address of End System Identifiers.

**Valid Values:** Any 12 hexadecimal digits

**Default Value:** none

**Example: enable esi**

```
ATM INTERFACE> enable esi 00:00:00:00:00:09
```

## Disable

Use the **disable** command to disable an ESI in the configuration. ATM components using disabled ESIs will not become active on the next router restart.

**Syntax:** `disable esi esi-address`

`esi esi-address`

Address of End System Identifiers.

**Valid Values:** Any 12 hexadecimal digits

**Default Value:** none

**Example:** disable esi

```
ATM INTERFACE> disable esi 00:00:00:00:00:09
```

## Exit

Use the **exit** command to return to the ATM Config> prompt.

**Syntax:** exit

**Example:** exit

```
ATM INTERFACE> exit
ATM Config>
```

---

## ATM Virtual Interface Concepts

An ATM Virtual Interface (AVI) creates the appearance of multiple ATM interfaces when, in fact, there is only one physical ATM interface. One or more AVIs can be configured for each physical ATM interface on the router. AVIs have the following characteristics:

- Each AVI must be defined on one (and only one) physical ATM interface. ATM real interface (ARI) will be used to mean a physical ATM interface.
- One or more AVIs can be configured on each ARI on a router.
- Higher layer protocols treat ARIs and AVIs equally. The protocols see the total number of ATM interfaces as the sum of the number of ARIs and AVIs configured on the router.
- Protocols can be configured on each ATM interface (real or virtual) independent of other interfaces.

For example, one can configure IP on interface 0 (which is a real ATM interface) with IP address 9.1.1.1 and another instance of IP with address 9.2.1.1 on interface 1 (which is an AVI). Whether an interface is a real ATM interface or a virtual interface configured on a real interface makes no difference to the protocol (IP in the example). In addition, whether virtual interface 1 is configured on top of real ATM interface 0 or some other physical ATM interface is also transparent to the protocols.

## Advantages of Using ATM Virtual Interfaces

Major advantages of using the ATM Virtual Interfaces are:

- Using the ATM Virtual Interface feature increases the number of protocol instances that can be supported on a physical ATM interface.

Up to 32 instances of a protocol can be supported on one physical ATM interface. However, by configuring an appropriate number of virtual interfaces on top of a real ATM interface, a much larger number of protocol instances can be supported. The actual number of AVIs that can be configured on an ARI is limited by physical resources, such as memory, available on the router. The total number of interfaces that can be created depends on the data packet size for the interfaces and is limited to a maximum number of 253 per router.

Currently, approximately 80 AVIs can be configured with a default data packet size of 9180 if no other interfaces are configured.

## ATM Virtual Interface Configuration Concepts

The use of AVIs significantly improves the configuration options for protocols such as IPX that are limited to one instance or address per ATM interface. By configuring an appropriate number of AVIs, several IPX addresses can be supported on each physical ATM interface.

- The ATM Virtual Interface feature is crucial for supporting multicast routing protocols (such as OSPF) over ATM networks.

In order for multicast to operate correctly, each logical subnet **MUST** be configured on a different interface because multicast routing protocols typically function in such a way that a packet coming in from a router interface will never be sent out over the same interface. Thus, if more than one subnet is configured on an interface and a source in one subnet sends a multicast packet to a member in another subnet defined on the same interface, this member will never receive the packet.

By creating an individual virtual interface for each subnet, packet multicasting can be performed successfully. Typically, the number of ATM interfaces on a router will be limited, in turn limiting the number of subnets that can be correctly configured for multicast operation. However, by creating as many AVIs as needed (according to the number of subnets that are required to be configured on the router), the number of physical ATM interfaces will no longer limit the number of subnets that can be configured on a router for correct multicast operation.

For example, the “one-armed” router cannot support multicast traffic over interfaces other than ELANs without the AVI feature, since incoming packets will never be sent out the same interface and will be discarded instead.

- Creating multiple AVIs on an ARI and configuring each different protocol instance (e.g., each IP subnet) on a different AVI on the same ARI, can improve performance.

For example, when multiple subnets are configured on a single physical ATM interface, the interface will have to reduce the maximum transmission unit or MTU (the maximum packet size that can be sent or received over that interface) to the smallest MTU of all subnets sharing the same interface. However, if multiple AVIs are created on that ARI and each IP subnet is configured on a different AVI, every subnet can continue to use its existing MTU size without consideration of other subnets configured on the same physical ATM interface. Possible reduction in throughput and delays due to packet fragmentation and re-assembly caused by MTU size reduction are avoided.

Another performance improvement can be achieved by distributing the number of protocol addresses configured on a physical interface over different virtual interfaces configured on the same physical interface. The per-interface protocol lists get shortened, resulting in faster searches and reduced processing time.

## Disadvantages of using ATM Virtual Interfaces

The disadvantages of using ATM Virtual Interfaces are:

- The use of the ATM Virtual Interfaces feature results in some additional processing every time a packet is sent or received over an ATM interface. This increased processing may or may not offset the performance advantages listed above.

- Since AVIs do not have any physical resources of their own, each virtual interface will have fewer Virtual Connections (VCs) than a single physical interface. The available resources (in this example VCs) are partitioned between the different virtual interfaces configured on a single ARI.

In the current implementation, resource allocation is *on demand*. Each physical ATM interface has a pool of resources which are available for use by all AVIs and the single ARI itself.

**Notes:**

1. Since all resources are shared among the ARI and all its AVIs, an ESI added on an ARI is automatically available to all AVIs configured on the ARI. You should not assign the same ESI and selector combination to two different protocol clients using the same ARI even though they are configured on different AVIs. Likewise, you should not configure different PVCs on the same ARI with the same VPI/VCI combination even though the PVCs are configured on different AVIs.
2. For MSS 1.1, the ATM virtual interface only supports IP and IPX over ATM. IP and IPX function over ATM virtual interfaces is identical to the function of these protocols over real ATM interfaces and configuration of these protocols on ATM virtual interfaces is identical to the protocol configuration on real ATM interfaces.  
  
MSS 1.1 does not support RFC 1483 Bridging over ATM on Virtual ATM interfaces.

### Access to the Virtual ATM Interface Configuration

From the ATM Config> prompt of a selected real ATM interface, use the **Virtual ATM** command to enter the Virtual ATM configuration command mode.

---

## ATM Virtual Interface Configuration Commands

This section summarizes the ATM Virtual Interface configuration commands. Enter the commands at the ATM virtual interface config> prompt.

<i>Table 19-3. ATM Virtual Interface Configuration Command Summary</i>	
Command	Function
<b>? (Help)</b>	Lists all of the ATM Virtual Interface configuration commands, or lists the options associated with specific commands.
<b>ADD</b>	Adds a virtual ATM interface.
<b>LIST</b>	Lists the current configured virtual ATM interfaces.
<b>REMOVE</b>	Removes the virtual ATM interface from the current configuration.
<b>EXIT</b>	Exit the ATM Virtual Interface Configuration process and return to the ATM Config> prompt.

# ATM Virtual Interface Configuration Commands

## Help (?)

Use the **help** command to list the configuration options for ATM Virtual Interfaces.

**Syntax:** `help (or?)`

**Example: help**

```
ATM Virtual Interface config> help
ADD
LIST
REMOVE
EXIT
ATM Virtual Interface config>
```

## Add

Use the **add** command to add an ATM Virtual Interface. A new ATM virtual interface is added to the corresponding ATM real interface (the configuration menu from which this ATM virtual interface configuration menu is accessed). The net/interface number assigned to the newly created ATM virtual interface is displayed and it is one number greater than the current largest interface number.

**Syntax:** `add`

**Example: add**

```
ATM Virtual Interface config> add
Added ATM Virtual Interface Net as interface 5 on physical ATM interface 0
ATM Virtual Interface config>
```

## List

Use the **list** command to list configured ATM Virtual Interfaces defined on the current real ATM interface.

**Syntax:** `list`

**Example: list**

```
ATM Virtual Interface config> list

                        ATM Virtual Interface Nets
-----
ATM interface number = 0
ATM Virtual Interface Net interface number = 5
ATM Virtual Interface config>
```

## Remove

Use the **remove** command to delete an ATM Virtual Interface interface. The virtual ATM interface on the real ATM interface with the specified interface number will be removed from the SRAM configuration records. If you do not specify an interface number, the last ATM Virtual Interface on this real ATM Interface will be deleted. If you enter a question mark (?), all ATM Virtual Interfaces on the current real ATM interface will be listed and you can select from that list the interface you want to remove.

**Syntax:** `remove n`

**Example: remove 5**



```
Virtual ATM 5 deleted successfully.  
ATM Virtual Interface config>
```

### Exit

Use the **exit** command exit configuration menu for ATM Virtual Interfaces defined on the current real ATM interface and return the the real ATM interface configuration prompt.

**Syntax:** `exit`

**Example:** `exit`

```
ATM Virtual Interface config> exit  
ATM config>
```

## ATM Virtual Interface Configuration Commands

---

## Chapter 20. Monitoring ATM

This chapter describes how to monitor the ATM interface. It includes the following sections:

- “Accessing the ATM Console Commands”
- “ATM Console Commands” on page 20-2
- “ATM Interface Console Commands (ATM INTERFACE+ Prompt)” on page 20-3

---

### Accessing the ATM Console Commands

Use the following procedure to access the ATM console commands. This process gives you access to an ATM's *monitoring* process.

1. At the OPCON prompt, enter **talk 5**. (For more detail on this command, refer to Chapter 5, “The OPCON Process and Commands.”) For example:

```
* talk 5
+
```

After you enter the **talk 5** command, the GWCON prompt (+) displays on the console. If the prompt does not appear when you first enter configuration, press **Return** again. To access the ATM interface console process, do the following:

2. Enter **interface** at the + prompt to display a list of configured interfaces.
3. Record the interface numbers.
4. To access the ATM interface console process, do the following:

Enter **network** followed by the number of the ATM interface.

```
+ network 5
ATM+
```

The ATM monitoring prompt (ATM+), is displayed.

---

### ATM Console Commands

This section summarizes the ATM console commands for monitoring ATM interfaces. Enter the commands at the ATM+ prompt.

*Table 20-1. ATM Console Command Summary*

<b>Command</b>	<b>Function</b>
<b>? (Help)</b>	Lists all of the ATM configuration commands, or lists the options associated with specific commands.
<b>INTERFACE</b>	Gets you to the ATM Interface+ prompt from which you can monitor the ATM Interface, as described in “ATM Interface Console Commands (ATM INTERFACE+ Prompt)” on page 20-3.
<b>LE-SERVICES</b>	Gets you to the LE Services+ prompt from which you can monitor LAN Emulation Services as described in Chapter 24, “Monitoring LAN Emulation Services” on page 24-1.
<b>Exit</b>	Exits the ATM Monitoring process and returns to the + prompt.

#### Interface

Gets you to the ATM Interface+ prompt, described in “ATM Interface Console Commands (ATM INTERFACE+ Prompt)” on page 20-3.

#### LE-Services

Gets you to the LE Services+ prompt. Refer to Chapter 24, “Monitoring LAN Emulation Services” on page 24-1.

#### Exit

Returns to the + prompt.

## ATM Interface Console Commands (ATM INTERFACE+ Prompt)

This section summarizes and then explains the commands for monitoring a specific ATM interface.

Enter the commands at the ATM INTERFACE+ prompt.

Table 20-2. ATM INTERFACE Configuration Command Summary

Command	Function
<b>? (Help)</b>	List all the ATM Interface configuration commands, or list the options associated with specific commands.
<b>List</b>	Lists various options
<b>Trace</b>	Starts/Stops packet tracing on a specified VPI/VCI range. Trace can be viewed by ELS.
<b>Wrap</b>	Starts/Stops a loopback test on the VCC.
<b>Exit</b>	Returns to the ATM+ prompt.

### List

Use the **list** command to list various categories of ATM data.

**Syntax:** `list`      addresses  
                               all  
                               circuit  
                               users  
                               vccs

#### addresses

Lists the ATM addresses in use on the router. The ATM address is displayed as the Network Prefix, the End System Identifier, and the Selector.

**Example: list addresses**

```
ATM INTERFACE+ list addresses
                        ATM Address
      Network Prefix      ESI      SEL
-----
39.84.0F.00.00.00.00.00.00.00.01.10.00.5A.00.DE.AD.03
39.84.0F.00.00.00.00.00.00.00.00.01.10.00.5A.00.DE.AD.02
```

#### all

Lists all of the following:

- Users
- Addresses
- VCCs

## ATM Interface Console Commands

### users

Lists all users of the ATM interface within the router. ATM users include all LECs, LES/BUSs, LECSs, LECS interfaces, and CIP-Clients.

#### Example: list users

```
ATM INTERFACE+ list users
```

UserHandle	FrameSap	ATM Address
2032AC50	2032AC5C	39.84.0F.00.00.00.00.00.00.00.00.00.01.10.00.5A.00.DE.AD.02
2030A978	2030A984	39.84.0F.00.00.00.00.00.00.00.00.00.01.10.00.5A.00.DE.AD.03

### circuit

Lists a the statistics for a particular VC by specifying the particular VCI-VPI pair. You can also specify the circuit on the command line; for example: list circuit 33.

#### Example: list circuit

```
ATM INTERFACE+ list circuit
```

```
VPI [0]?
```

```
VCI [32]?33
```

```
Frames transmitted = 2 Bytes transmitted = 216
Frames received = 2 Bytes received = 216
```

### VCCS

Lists all the VCCs established by the router. The VCCs may be permanent (PVC) or switched (SVC), point-to-point or point-to-multipoint and each is identified by a unique VPI/VCI. The trace command uses the VPI/VCI value for a VCC to perform packet tracing over a particular VCC.

#### Example: list vccs

```
ATM INTERFACE+ list vccs
```

Conn Bytes Handle	Conn Type	VPI	VCI	FrameSap	Frames Transmitted	Frames Received	Bytes Transmitted	Bytes Received
13 0	P-MP	0	38	2032AC5C	0	0	0	13
10	P-P	0	35	2032DC74	0	62	0	5532
9	P-P	0	34	2032DC74	62	0	5532	0
8	P-P	0	33	2032DC74	0	0	0	0
7	P-P	0	32	2032DC74	2	2	216	216
1	SAAL	0	5	0	582	581	5052	7232
2	ILMI	0	16	0	127	126	5551	8631

*P-P* point to point VCC

*P-MP* point to multipoint VCC

*ILMI* Interim Local Management Interface VCC

*SAAL* signalling VCC

## Trace

Use the **trace** command activate packet tracing over a specified range of VPI/VCI values. You can view trace data by using ELS as described in "View" on page 12-15.

**Syntax:** trace     list  
                           on  
                           off

list

Displays the current packet tracing options on the ATM interface.

**Example: trace list**

```
ATM Interface+ trace
on | off | list []? list
Packet trace is ON
Range of VPIs to be traced:      0 -      0
Range of VCIs to be traced:     32 -     39
```

on

Starts packet tracing on all active VCCs within the specified VPI/VCI range.

**Example: trace on**

```
ATM Interface+ trace on
beginning of VPI range [0]?
end of VPI range [0]?
beginning of VCI range [32]?
end of VCI range [65535]? 39
```

off

Stops packet tracing on all VCCs.

**Example: trace off**

```
ATM Interface+ trace off
ATM Interface+ trace list
Packet trace is OFF
```

## Wrap

Use the **wrap** command to perform a loopback data test on the ATM interface of the adapter. Wrap can be issued on a per VC basis by specifying VPI-VCI pairs. Data is looped back internally.

You can selectively start a wrap, stop a wrap, or display the current wrap settings.

If you stop or display a wrap, the following statistics will be displayed:

- Wrap transmits
- Wrap receives
- Wrap transmit errors
- Wrap receive errors
- Wrap receive timeouts

For display, the current the current wrap statistics are displayed.

For stop, the final wrap statistics are displayed.

**Syntax:** wrap     display  
                           start  
                           stop

display

Displays the current wrap settings.

## ATM Interface Console Commands

### start

Starts the wrap procedure and specifies the VPI-VCI length of pattern and the pattern itself.

#### **Example: wrap start**

```
ATM Interface+ wrap start
VPI [0]?
VCI [32]?
wrap pattern length [32]?
Enter 32-byte wrap pattern: [ABCDEFGHIJKLMNOPQRSTUVWXYZ123456]?
```

### stop

Stops the wrap procedure and displays final wrap statistics.

## Exit

Use the **exit** command to return to the previous prompt level.

**Syntax:** exit

**Example:** **exit**



---

## Chapter 21. Using and Configuring LAN Emulation Clients

This chapter describes LAN Emulation Clients (LECs). It includes the following sections:

- “LAN Emulation Client Overview”
- “Configuring LAN Emulation Clients (LE Client Config>)” on page 21-2
- “Configuring an ATM Forum-Compliant LE Client” on page 21-5
- “Configuring an IBM LE Client” on page 21-15

---

### LAN Emulation Client Overview

As a pioneer of ATM technology, IBM defined one of the early LAN Emulation architectures. The ATM Forum LAN Emulation Specification diverged from IBM's architecture in a number of ways. IBM, like several other vendors, now has products that implement two different LAN Emulation architectures: earlier products implement the IBM LAN Emulation Architecture, while more recently developed products implement the ATM Forum LAN Emulation Specification. The MSS Server implements LE Clients for both architectures, but LE Servers for ATM Forum LAN Emulation only.

Although ATM Forum LAN Emulation is the strategic direction for multivendor interoperability, customers that have installed products implementing the IBM LAN Emulation Architecture must also be supported. These customers will generally fall into one of the following two categories:

1. Those who wish to continue using IBM LAN Emulation, which offers some technical advantages relative to the ATM Forum LAN Emulation
2. Those who wish to migrate to ATM Forum LAN Emulation.

The MSS Server can provide routing and bridging services that support any combination of ATM Forum or IBM LAN Emulation clients. From routing and bridging perspectives, IBM LECs are functionally equivalent to ATM Forum LECs; both provide emulated Ethernet and Token-Ring interfaces with operational characteristics of real interfaces. You can configure a LEC to be either of these types:

- Ethernet
  - ATM Forum-Compliant
  - IBM
- Token-Ring
  - ATM Forum-Compliant
  - IBM

LECs are equivalent to “ports” or “interfaces” on traditional routers and bridges. The router bridges and routes traffic between emulated LANs by receiving and transmitting traffic through its LECs.

There are two levels to the configuration menus for LE Clients:

1. LE Client Config> permits you to view the set of LE Clients on a particular ATM interface, to add or remove LECs from this set, or to enter into a more detailed configuration environment for any member of this set (see LEC

commands in the following). The commands for this prompt level are described in “Configuring LAN Emulation Clients (LE Client Config>)” on page 21-2.

2. Token-Ring-Forum LEC Config>, Token-Ring-IBM LEC Config>, Ethernet-Forum LEC Config>, or Ethernet-IBM LEC Config> permits you to configure all parameters for a particular LE Client. The commands available at this level are described in “Configuring an ATM Forum-Compliant LE Client” on page 21-5 and “Configuring an IBM LE Client” on page 21-15.

An explanation of commands for LAN Emulation Clients follows.

---

## Configuring LAN Emulation Clients (LE Client Config>)

This section explains the commands for viewing, changing, using the set of LE Clients on a particular ATM interface.

Enter the commands at the LE Client Config> prompt under the ATM Config> prompt, as described in “ATM Configuration Commands” on page 19-3.

To get to the LE Client Config> prompt, enter **le-c** at the ATM Config> prompt as described in “ATM Configuration Commands” on page 19-3.

*Table 21-1. LAN EMULATION Client Configuration(?) Commands Summary*

Command	Function
<b>? (Help)</b>	Lists the console commands or list the actions associated with specific commands
<b>Add</b>	Adds a LEC for the following types of Emulated LANs architectures: <ul style="list-style-type: none"><li>• Ethernet<ul style="list-style-type: none"><li>– ATM Forum-Compliant</li><li>– IBM</li></ul></li><li>• Token-Ring<ul style="list-style-type: none"><li>– ATM Forum-Compliant</li><li>– IBM</li></ul></li></ul>
<b>Config</b>	Gets you to the LEC Config> prompt, from which you can configure a specific LAN Emulation Client as described in: <ul style="list-style-type: none"><li>• “Configuring an ATM Forum-Compliant LE Client” on page 21-5</li><li>• “Configuring an IBM LE Client” on page 21-15</li></ul>
<b>List</b>	Lists the LECs
<b>Remove</b>	Removes a LEC.
<b>Exit</b>	Returns to the previous prompt.

## Help

Use the **? (help)** command to list the commands that are available from the current prompt level. You also can enter a ? after a specific command name to list its options.

**Syntax:** ?

**Example:** ?

```
ADD
CONFIG
LIST
REMOVE
EXIT
```

## Add

Use the **add** command to add an ATM Forum-compliant or IBM LEC for a Token-Ring or Ethernet emulated LAN.

**Syntax:** add            Ethernet Forum  
                           Ethernet IBM  
                           Token Ring Forum  
                           Token Ring IBM

token ring forum  
 Token ring ATM Forum compliant LEC.

**Example:** **add token ring forum**

```
LE Client Config> add token ring forum
Added device as interface 3
```

token ring IBM  
 Token ring IBM LEC.

**Example:** **add token ring ibm**

```
LE Client Config> add token ring ibm
Added device as interface 3
```

ethernet forum  
 Ethernet Forum-Compliant LEC.

**Example:** **add ethernet forum**

```
LE Client Config> add ethernet forum
Added device as interface 2
```

ethernet IBM  
 Ethernet IBM LEC.

**Example:** **add ethernet ibm**

```
LE Client Config> add ethernet ibm
Added device as interface 1
```

## Config

Use the **config** command to get you to the LEC Config> prompt, from which you can configure the details of a specific LAN Emulation Client. Refer to “Configuring an ATM Forum-Compliant LE Client” on page 21-5 or “Configuring an IBM LE Client” on page 21-15.

**Syntax:** config interface#

interface#

An integer number assigned by the router when the LEC was added to the configuration. Use the **list** command to determine the number interface number assigned to the LEC.

**Example: config**

```
LE Client Config> config 3
```

## List

Use the **list** command to list the LAN emulation clients.

**Syntax:** list

**Example: list**

```
LE Client Config> list
                        ATM Emulated LANs
-----
ATM interface number = 0
LEC interface number = 1
Emulated LAN type    = Token Ring
Emulated LAN name    =
```

## Remove

Use the **remove** command to remove a LEC. You must specify the interface number that was assigned when the LEC was added to the configuration. Use the **list** command to determine the interface number assigned to the LEC.

**Syntax:** remove interface#

interface#

An integer number assigned by the router.

## Exit

Use the **exit** command to return to the previous prompt.

## Configuring an ATM Forum-Compliant LE Client

This section explains the commands for configuring an ATM Forum-compliant LAN Emulation Client. Enter the appropriate commands at either the Ethernet-Forum LE Client Config> prompt or the Token-Ring-Forum LE Client Config> prompt. Commands in the following table apply to both types of LECs except where indicated.

Enter the commands at the LEC Config> prompt after entering the **config** command at the LE Client Config> prompt.

*Table 21-2. LAN Emulation Client Configuration Commands Summary*

Command	Function
<b>? (Help)</b>	Lists the console commands or lists the actions associated with a particular command.
<b>Frame</b>	Sets the NetWare IPX encapsulation type.
<b>RIF-Timer</b>	Sets the maximum amount of time that information in the RIF is maintained before it is refreshed. Applies only to Token-Ring LECs.
<b>Source-routing</b>	Used to enable or disable source-route bridging. Applies only to Token-Ring LECs.
<b>IP-Encapsulation</b>	Sets the IP encapsulation as Ethernet (type X'0800') or IEEE (802.3 with SNAP). Applies only to Ethernet LECs.
<b>List</b>	Lists the LAN Emulation Client configuration.
<b>QoS</b>	Gets you to the e1an-x LEC QoS Config> prompt from which you can configure Quality of Service as described in "LE Client QoS Configuration Commands" on page 16-7.
<b>Set</b>	Sets the LAN Emulation Client parameters.
<b>Exit</b>	Returns to the previous prompt.

## Help

Use the **? (help)** command to list the commands that are available from the current prompt level. You also can enter a ? after a specific command name to list its options.

**Syntax:** ?

**Example:** ?

```
LIST
SET
EXIT
```

## Frame

Use the **frame** command to set the NetWare IPX encapsulation type. The command options differ depending on the type of LEC (Token-Ring or Ethernet). For Token-Ring LECs, enter one of the following:

Option	Description	Syntax
<i>Token-Ring using MSB</i>	Uses the standard 802.2 IPX header with the noncanonical Token-Ring address bit ordering (MSB).	<b>frame token-ring msb</b>
<i>Token-Ring using LSB</i>	Uses the 802.2 IPX header with the canonical address bit ordering (LSB).	<b>frame token-ring lsb</b>
<i>Token-Ring with 802.2 SNAP using MSB</i>	Uses the 802.2 format with a SNAP header and noncanonical address bit ordering. This encapsulation is used primarily in bridging environments.	<b>frame token-ring_snap msb</b>
<i>Token-Ring with 802.2 SNAP using LSB</i>	Uses the 802.2 format with a SNAP header and canonical address bit ordering.	<b>frame token-ring_snap lsb</b>
<i>Ethernet 2.0</i>	Uses Ethernet version 2.0 protocol 81-37.	<b>frame ethernet_II</b>
<i>Ethernet 802.2</i>	Uses Ethernet 802.3 with 802.2 SA E0	<b>frame ethernet_8022</b>
<i>Ethernet 802.3</i>	Uses Ethernet 802.3 without any 802.2 header	<b>frame ethernet_802.3</b>
<i>Ethernet SNAP</i>	Uses 802.3, 802.2 with SNAP PID 00-00-00-81-37	<b>frame ethernet_SNAP</b>

**Syntax:** `frame ipx-encapsulation type`

Note: The frame command cannot be used in the network configuration process to set the IPX encapsulation unless the interface has been configured with IPX.

The IPX encapsulation can also be set in the IPX configuration environment. Refer to the Multiprotocol Switched Services (MSS) Server Command Line Interface Volume 2 chapter on Configuring IPX for details.

**Example:** `frame token_ring msb`

## RIF-Timer (for Token-Ring Forum-compliant LEC only)

Use the **RIF-Timer** command to set the maximum amount of time that information in the RIF is maintained before it is refreshed. Range is 0 to 4096. The default is 120.

**Syntax:** `rif-timer`

**Example:** `rif-timer 100`

## Source-routing (for Token-Ring Forum-compliant LEC only)

Use the **source-routing** command to enable or disable end station source-routing. Source routing is the process by which end stations determine the source route to use to cross source routing bridges. Source routing allows the IP, IPX, and AppleTalk Phase 2 protocols to reach nodes on the other side of the source route bridge.

This function of the MSS Server is not changed whether source routing is enabled or disabled. The default setting is enabled.

Some stations cannot properly receive frames with Source Routing RIF on them. This is especially common among NetWare drivers. Disabling source routing in this situation will allow you to communicate with these stations.

Source routing should be enabled only if there are source-routing bridges on this ring through which you want to bridge IP, IPX, and AppleTalk Phase 2 packets. Source routing must also be enabled so that LLC test response messages can be returned.

**Syntax:** `source-routing enable`  
`disable`

**Example:** `source-routing disable`

## IP-Encapsulation (for Ethernet Forum-compliant LEC only)

Use the **IP-encapsulation** command to select Ethernet (Ethernet type X'0800') or IEEE 802.3 (Ethernet 802.3 with SNAP). Specify either type Ethernet or IEEE-803.3.

**Syntax:** `IP-encapsulation type`

**Example:** `IP-encapsulation E`

## List

Use the **list** command to list the LE client configuration.

**Syntax:** `list`

**Example:** `list`

## QoS

Use the **qos-configuration** command to get you to the `elan-x LEC QoS Config>` prompt from which you can configure Quality of Service as described in "LE Client QoS Configuration Commands" on page 16-7.

**Syntax:** `qos-configuration`

## Set

Use the **set** command to set LE Client parameters.

**Syntax:** `set aging-time`  
`arp-cache-size`  
`arp-queue-depth`  
`arp-response-time`

auto-config  
best-effort-peakrate  
config-retries  
conn-completion-time  
control-timeout  
elan-name  
esi-address  
flush-timeout  
forward-delay  
frame-size  
lecs-atm-address  
les-atm-address  
mac-address  
multicast-send-avg  
multicast-send-peak  
multicast-send-type  
path-switch-delay  
retry-count  
selector  
trace  
unknown-count  
unknown-time  
vcc-timeout

aging-time

Sets aging time. This is the maximum time that a LEC will maintain an entry in its LE\_ARP cache in the absence of a verification of that relationship. A larger aging time may result in a faster session setup time, but may also use more memory and reacts slower to changes in network configuration.

**Valid Values:** An integer number of seconds in the range of 10 to 300.

**Default Value:** 300

**Example:** set aging-time

```
LEC Config> set aging-time 200
```

arp-cache-size

Sets the number of entries in the ARP cache. The size of the ARP cache limits the number of simultaneous data direct VCCs. Larger ARP caches require more memory, but permits the client to simultaneously converse with a larger number of destinations.

**Valid Values:** An integer number in the range of 10 to 1000.

**Default Value:** 100

**Example:** set arp-cache-size

```
LEC Config> set arp-cache-size 10
```

arp-queue-depth

Sets the maximum number of queued frames per ARP cache entry. The LEC enqueues frames when switching the data path from the Multicast Send VCC to a Data Direct VCC. Frames passed to the LEC for transmission will be discarded if the queue is full. A larger queue requires more memory, but results in fewer discarded frames during the data path switch.



**Valid Values:** An integer number in the range of 0 to 10.  
**Default Value:** 5

**Example: set arp-queue-depth**

```
LEC Config> set arp-queue-depth 10
```

#### arp-response-time

Sets expected ARP response time. This value controls how frequently an unanswered LE ARP request is retried. Larger values result in fewer LE ARPs, which causes less traffic and possibly increase the amount of time before a Data Direct VCC is established.

**Valid Values:** An integer number of seconds in the range of 1 to 30.

**Default Value:** 1 second

**Example: set arp-response-time**

```
LEC Config> set arp-response-time 20
```

#### auto-config

Specifies whether this LEC uses LECS auto-config mode. Specify YES or NO. The LEC may contact the LECS to obtain the address of its LES and various other configuration parameters. This value must be Yes for the client to use a redundant IBM MSS Server LES.

**Valid Values:** If YES, then you do not have to configure the ATM address of the LES.

If NO, then you *must* configure the ATM address of the LES using the **set les-atm-address** command as described on page 21-12.

**Default Value:** NO

21-12.

**Example: set les auto-config**

```
LEC Config> set les auto-config yes
```

#### best-effort-peakrate

Sets the Best Effort Peak Rate. Used when establishing best effort multicast send connections.

The maximum peak rate depends on the maximum data rate of the ATM device.

Specify an integer from 1 to the maximum peak rate in Kbps (the definition is the maximum data rate) as follows:

- If ATM maximum data rate is 25 Mbps, the maximum peak rate is 25,000 Kbps.
- If ATM maximum data rate is 155 Mbps, the maximum peak rate is 155,000 Kbps.

**Valid Values:** An integer number in the range of 10 - device maximum data rate.

**Default Value:** 155000 Kbps

**Example: set best-effort-peakrate**

```
LEC Config> set best-effort-peakrate 24000
```

### config-retries

Sets the number of configuration retries.

If the client is unable to connect to the LES address given to it in a configure response, the client will send another configure request to the LECS before releasing the configuration direct VCC. This value controls how many retries are made before the client releases the configuration direct VCC. When this limit is reached, the client will sleep for a period of time (not exceeding 30 seconds) and restart the configuration phase. Interoperability problems may arise if this value is set to zero.

**Valid Values:** An integer number in the range of 0 to 5.

**Default Value:** 3

**Example:** `set config-retries`

```
LEC Config> set config-retries 4
```

### connection-completion-time

Sets the connection completion time. This is the time interval in which data or a READY\_IND message is expected from a calling party.

When a Data Direct VCC is established to the client, the LEC expects data or a READY\_IND message within this time period. The LEC will not transmit frames over a Data Direct VCC established to it until receiving data or a READY\_IND. This parameter value controls the amount of time which passes before the LEC issues a READY QUERY (in hopes of receiving a READY\_IND). Smaller values lead to faster response times, but also to unnecessary transmissions.

**Valid Values:** An integer number of seconds in the range of 1 to 10.

**Default Value:** 4 seconds

**Example:** `set connection-completion-time`

```
LEC Config> set connection-completion-time 5
```

### control-timeout

Sets the control timeout. This is the timeout period used for timing out most request/response control frame interactions. Smaller timeout values result in more traffic and may result in faster response times.

**Valid Values:** An integer number of seconds in the range of 10 to 300.

**Default Value:** 30 seconds

**Example:** `set control-timeout`

```
LEC Config> set control-timeout 100
```

### elan-name

Specifies name of the ELAN that the LEC wishes to join.

**Valid Values:** Any character string length of 0 - 32 bytes.

**Default Value:** Blank

This is the ELAN name sent to the LECS in the configure request (if the LEC autoconfigures) or to the LES in the join request. The LECS or LES may return a different ELAN name in the response.

**Note:** A blank name (0 length string) is valid.

**Example:** `set elan-name`

```
LEC Config> set e!an-name FUZZY
```

#### esi-address

Sets the ESI portion of the LEC's ATM address.

Specify the ESI portion (octets 13 through 19) of the LEC's ATM address. The ESI and selector combination of the LEC must be unique among all LAN emulation components on the MSS Server.

**Valid Values:** Any 12 hexadecimal digits.

**Default Value:** none

**Example: set esi**

```
Select ESI
(1) Use burned in ESI
(2) 11.22.33.44.55.66
```

```
Enter selection [1]?
```

#### flush-timeout

Sets the flush timeout. This is the time limit to wait to receive the LE\_FLUSH\_RESPONSE after the LE\_FLUSH\_REQUEST has been sent before taking recovery action. This is the amount of time between flush requests when the LEC is attempting to switch to a Data Direct connection.

When switching from the multicast send to a data direct data path, the client sends a flush request over the multicast send VCC. Until a flush response is received, or until the path switch delay expires, frames are queued for the destination. A smaller timeout generates more flush traffic, but may result in fewer discarded data frames.

**Valid Values:** An integer number of seconds in the range of 1 to 4.

**Default Value:** 4 seconds

**Example: set flush-timeout**

```
LEC Config> set flush-timeout 3
```

#### forward-delay

Sets the forward delay. Entries in the LE ARP cache must be periodically reverified. The forward delay time is the maximum amount of time a remote entry may remain in the cache during a network topology change. Larger aging times may result in stale (invalid) entries, but also cause less reverification traffic.

**Valid Values:** An integer number of seconds in the range of 4 to 30.

**Default Value:** 15 seconds

**Example: set forward-delay**

```
LEC Config> set forward-delay 10
```

#### frame-size

Sets the frame size.

The value specified for frame-size must be equal to or less than the value specified for ATM max-frame using the ATM INTERFACE> **set max-frame** command as described on page 19-7.

**Valid Values:** 1516  
4544  
9234  
18190  
**Default Value:** If the ELAN type is token ring, the default is 4544. If the ELAN type is Ethernet, the default is 1516.

**Example: set frame-size**

```
LEC Config> set frame-size 4544
```

### lecs-atm-address

Specifies the ATM address of the LECS.

If the client is set to auto configure, it attempts to connect to a LECS. If it is unable to connect to a LECS, then it may try another LECS ATM address. The LECS ATM addresses that are tried, in order, are:

1. This configured LECS address
2. Any LECS address obtained through ILMI
3. The well-known LECS address defined by the ATM Forum.

No default is provided.

**Note:** This command should be entered on one command line. It is shown here on two lines because of spacing.

**Example: set lecs-atm-address**

```
LEC Config> set lecs-atm-address  
39.84.0F.00.00.00.00.00.00.00.00.00.01.10.00.5A.00.DE.AD.01
```

### les-atm-address

Sets the LES ATM address. This command may be optional or required depending upon the setting of lecs-auto-config as described in the **set lecs-auto-config** command on page 21-9.

- If lecs-auto-config is YES, the les-atm-address is not configurable.
- If lecs-auto-config is NO, then the les-atm-address is required.

Specify the ATM address of the LES. No default is provided.

**Note:** This command should be entered on one command line. It is shown here on two lines because of spacing.

**Example: set les-atm-address**

```
LEC Config> set les-atm-address  
39.84.0F.00.00.00.00.00.00.00.00.00.01.10.00.5A.00.DE.AD.02
```

### mac-address

Sets the MAC address for this LE client. You *may* specify that the client use the burned-in MAC address of the ATM interface, or you may specify a different MAC address. If you have two clients that are bridged together, they should use different MAC addresses.

This MAC address is registered with the LES when the client joins the ELAN.

**Valid Values:** Any valid MAC address.

**Default Value:** none

**Example: set mac-address**

```
LEC Config> set mac-address FF.FF.FF.FF.FF.FF.01
```

**multicast-send-avg**

Sets the multicast send VCC average rate in Kbps. Used by the LEC for reserving bandwidth on the VCC to the BUS. It specifies the forward and backward sustained cell rate used when setting up a reserved bandwidth multicast send VCC.

This parameter is only applicable when the multicast-send-type is reserved bandwidth. If multicast-send-avg equals multicast-send-peak, then a constant bit rate (CBR) multicast send is signalled. Otherwise, a variable bit rate (VBR) multicast send is signalled. Multicast-send-avg must at least equal multicast-send peak.

A reserved bandwidth multicast send VCC may improve data transfer rates in congested networks, but reserving bandwidth and not using it wastes network resources.

When the multicast-send-type is reserved, then multicast-send-avg and multicast-send-peak must be specified.

**Example: set multicast-send-avg**

```
LEC Config> set multicast-send-avg 4000
```

**multicast-send-peak**

Sets the multicast send peak rate in Kbps. Used by LEC for reserving bandwidth on the VCC to the BUS. It specifies the forward and backward peak cell rate used when establishing a reserved bandwidth multicast send VCC.

This parameter is only applicable when the multicast-send-type is reserved bandwidth. If multicast-send-avg equals multicast-send-peak, then a constant bit rate (CBR) multicast send is signalled. Otherwise, a variable bit rate (VBR) multicast send is signalled. Multicast-send-avg must at least equal multicast-send peak.

A reserved bandwidth multicast send VCC may improve data transfer rates in congested networks, but reserving bandwidth and not using it wastes network resources.

When the multicast-send-type is reserved, then multicast-send-avg and multicast-send-peak must be specified.

**Example: set multicast-send-peak**

```
LEC Config> set multicast-send-peak 155
```

**multicast-send-type**

Sets the multicast send type. Specifies the method used by the LEC when establishing the multicast send VCC.

If multicast-send-avg equals multicast-send-peak, then a constant bit rate (CBR) multicast send is signalled. Otherwise, a variable bit rate (VBR) multicast send is signalled. Multicast-send-avg must at least equal multicast-send peak.

A reserved bandwidth multicast send VCC may improve data transfer rates in congested networks, but reserving bandwidth and not using it wastes network resources.

When the multicast-send-type is reserved, then multicast-send-no and multicast-send-peak must be specified.

**Valid Values:** Best Effort or Reserved

**Default Value:** Best Effort

**Example:** `set multicast-send-type`

LEC Config> `set multicast-send-type best-effort`

#### path-switch-delay

Sets the path switch delay.

The LEC must ensure that all frames sent through the BUS to a destination have arrived at the destination before it can start using a Data Direct VCC. This is accomplished using the flush protocol, or by waiting path-switch-delay seconds after sending the last packet to the BUS. Smaller values improve performance, but may result in out-of-order packets in a heavily congested network.

**Valid Values:** An integer number of seconds in the range of 1 to 8.

**Default Value:** 6 seconds

**Example:** `set path-switch-delay`

LEC Config> `set path-switch-delay 5`

#### retry-count

Sets the retry count. This is maximum number of times that the LEC retries an LE\_ARP\_REQUEST for a specific frame's LAN destination. If no ARP response is received after the specified number of retries, then the entry is purged from the LE ARP cache.

**Valid Values:** An integer number in the range of 0 to 2.

**Default Value:** 1

**Example:** `set retry-count`

LEC Config> `set retry-count 2`

#### selector

Specifies the selector portion of the client's ATM address. The combination of ESI and selector must be unique among all LANE components on the MSS Server. By default, a unique selector is selected for the configured ESI.

**Valid Values:** Any octet, in hexadecimal, that is not in use by another LANE component with the same ESI.

**Example:** `set selector`

LEC Config> `set selector 01`

#### trace

Enables tracing for the LEC. To perform packet tracing, three steps are required:

1. Enable packet tracing system (under ELS)
2. Enable tracing on the LEC subsystem (under ELS)
3. Enable packet tracing on the desired LECs (using this command).

**Valid Values:** Enable or Disable

**Default Value:** Disable

**Example:** Token Ring LEC config>`set trace`

Trace packets on the LEC? [No]?yes

#### unknown-count

Sets the unknown frame count. This is the maximum number of frames for a specific unicast MAC address or route descriptor that may be sent

to the BUS within the time specified by the unknown-time parameter. Larger values decrease the number of discarded frames while increasing the load on the BUS.

**Valid Values:** An integer number of frames in the range of 1 to 255.  
**Default Value:** 10

**Example: set unknown-count**

LEC Config> set unknown-count

unknown-time

Sets the unknown frame time. This is the time interval during which the maximum number of frames for a specific unicast MAC address or route descriptor (specified by the unknown-count parameter) may be sent to the BUS. Larger values increase the number of discarded frames while decreasing the load on the BUS.

**Valid Values:** An integer number of seconds in the range of 1 to 60.  
**Default Value:** 1

**Example: set unknown-time**

LEC Config> set unknown-time 5

vcc-timeout

Sets the VCC timeout. Data direct VCCs over which no traffic has been sent for this period of time should be released.

Specify an integer number in the range 0 to 31536000 seconds (1 year).

Default: 1200 seconds = 20 minutes

**Note:** This parameter is meaningful only for SVC connections.

**Example: set vcc-timeout**

LEC Config> set vcc-timeout 1000

## Exit

Use the **exit** command to return to the LE Client Config> prompt.

## Configuring an IBM LE Client

This section summarizes and then explains the commands for configuring an IBM LAN Emulation Client.

Enter the appropriate commands at either the Ethernet-IBM LEC Config> prompt or the Token-Ring-IBM LEC Config> prompt. Commands in the following table apply to both types of LECs except where indicated.

<i>Table 21-3 (Page 1 of 2). Ethernet IBM LAN Emulation Client Configuration Commands Summary</i>	
<b>Command</b>	<b>Function</b>
<b>? (Help)</b>	Lists the console commands or lists the actions associated with specific commands
<b>Frame</b>	Sets the NetWare IPX encapsulation type.

Table 21-3 (Page 2 of 2). Ethernet IBM LAN Emulation Client Configuration Commands Summary

Command	Function
<b>RIF-Timer</b>	Sets the maximum amount of time that information in the RIF is maintained before it is refreshed. Applies only to Token-Ring LECs.
<b>Source-routing</b>	Used to enable or disable source-route bridging. Applies only to Token-Ring LECs.
<b>IP-Encapsulation</b>	Sets the IP encapsulation as Ethernet (type X'0800') or IEEE (802.3 with SNAP). Applies only to Ethernet LECs.
<b>List</b>	Lists the LAN Emulation Client configuration.
<b>Set</b>	Sets the IBM LAN Emulation Client parameters.
<b>Exit</b>	Returns to the previous prompt.

## Help

Use the **? (help)** command to list the commands that are available from the current prompt level. You also can enter a ? after a specific command name to list its options.

**Syntax:** ?

**Example for Ethernet:** ?

```
FRAME
IP-ENCAPSULATION
LIST
SET
EXIT
```

**Example for Token-Ring:** ?

```
FRAME
RIF-TIMER
SOURCE-ROUTING
LIST
SET
EXIT
```

## Frame

Use the **frame** command to set the NetWare IPX encapsulation type. The command options differ depending on the type of LEC (Ethernet or Token-Ring) For Token-Ring LECs, enter one of the following:



Option	Description	Syntax
<i>Token-Ring using MSB</i>	Uses the standard 802.2 IPX header with the noncanonical Token-Ring address bit ordering (MSB).	<b>frame token-ring msb</b>
<i>Token-Ring using LSB</i>	Uses the 802.2 IPX header with the canonical address bit ordering (LSB).	<b>frame token-ring lsb</b>
<i>Token-Ring with 802.2 SNAP using MSB</i>	Uses the 802.2 format with a SNAP header and noncanonical address bit ordering. This encapsulation is used primarily in bridging environments.	<b>frame token-ring_snap msb</b>
<i>Token-Ring with 802.2 SNAP using LSB</i>	Uses the 802.2 format with a SNAP header and canonical address bit ordering.	<b>frame token-ring_snap lsb</b>
<i>Ethernet 2.0</i>	Uses Ethernet version 2.0 protocol 81-37.	<b>frame ethernet_II</b>
<i>Ethernet 802.2</i>	Uses Ethernet 802.3 with 802.2 SA E0	<b>frame ethernet_8022</b>
<i>Ethernet 802.3</i>	Uses Ethernet 802.3 without any 802.2 header	<b>frame ethernet_802.3</b>
<i>Ethernet SNAP</i>	Uses 802.3, 802.2 with SNAP PID 00-00-00-81-37	<b>frame ethernet_SNAP</b>

**Syntax:** `frame ipx-encapsulation type`

Note: The frame command cannot be used in the network configuration process to set the IPX encapsulation unless the interface has been configured with IPX.

The IPX encapsulation can also be set in the IPX configuration environment. Refer to the Multiprotocol Switched Services (MSS) Server Command Line Interface Volume 2 chapter on Configuring IPX for details.

**Example:** `frame token_ring msb`

## RIF-Timer (for Token-Ring-IBM LEC only)

Use the **RIF-Timer** command to set the maximum amount of time that information in the RIF is maintained before it is refreshed. Range is 0 to 4096. The default is 120.

**Syntax:** `rif-timer`

**Example:** `rif-timer 100`

## Source-routing (for Token-Ring-IBM LEC only)

Use the **source-routing** command to enable or disable end station source-routing. Source routing is the process by which end stations determine the source route to use to cross source routing bridges. Source routing allows the IP, IPX, and AppleTalk Phase 2 protocols to reach nodes on the other side of the source route bridge.

This function of the MSS Server is not changed whether source routing is enabled or disabled. The default setting is enabled.

Some stations cannot properly receive frames with Source Routing RIF on them. This is especially common among NetWare drivers. Disabling source routing in this situation will allow you to communicate with these stations.

Source routing should be enabled only if there are source-routing bridges on this ring through which you want to bridge IP, IPX, and AppleTalk Phase 2 packets. Source routing must also be enabled so that LLC test response messages can be returned.

**Syntax:** `source-routing` enable  
disable

**Example:** `source-routing disable`

## IP-Encapsulation (for Ethernet-IBM LEC only)

Use the **IP-encapsulation** command to select Ethernet (Ethernet type X'0800') or IEEE 802.3 (Ethernet 802.3 with SNAP). Specify either type **Ethernet** or **IEEE-803.3**.

**Syntax:** `IP-encapsulation` *type*

**Example:** `IP-encapsulation E`

## List

Use the **list** command to list the LE client configuration.

**Syntax:** `list`

**Example:** `list`

## Set

Use the **set** command to set IBM LE Client parameters.

**Syntax:** `set` backward-peakrate  
esi-address  
frame-size  
forward-peakrate  
keep-alive-count  
les-atm-address  
mac-address  
mac-cache-size  
mac-cache-aging-period  
rd-cache-size  
rd-cache-aging-period

registration interval  
retry-count  
selector  
trace

**backward-peakrate**

This parameter specifies the maximum data rate (backward peak rate), in Kbps, of the ATM device for all LAN emulation connections.

Specify an integer from 1 to the maximum data rate of the ATM device.

Default: line rate in Kbps

**Example: set backward-peakrate**

```
LEC Config> set backward-peakrate 155000
```

**esi-address**

Sets the ESI portion of the client's ATM address.

**Valid Values:** Any 12 hexadecimal digits.

**Default Value:** none

**Example: token ring lec config>set esi**

```
Select ESI
(1) Use burned in ESI
(2) 11.22.33.44.55.66
```

```
Enter selection [1]?
```

**frame-size**

Sets the frame size.

The value specified for frame-size must be equal to or less than the value specified for ATM max-frame using the ATM INTERFACE> **set max-frame** command as described on page 19-7. The specified maximum frame size includes any Layer 2 header information. All transparently bridged LANs must have the same maximum frame size.

**Valid Values:** 1024 - 17843

**Default Value:** If the ELAN type is token ring, the default is 4551. If the ELAN type is Ethernet, the default is 1523.

**forward-peakrate**

This parameter specifies the maximum data rate (forward peak rate), in Kbps, of the ATM device for all LAN emulation connections.

Specify a decimal integer between 1 and the maximum data rate of the ATM device.

Default: data rate in Kbps

**Example: set forward-peakrate**

```
Ethernet IBM LEC Config> set forward-peakrate 155000
```

**keep-alive-count**

Specifies the number of times that the LEC sends a registration message without requiring a response from the LES.

Specify a decimal integer between 5 and 50.

Default: 10

**Example: set keep-alive-count**

```
Ethernet IBM LEC Config> set keep-alive-count 20
```

### les-atm-address

Sets the LES ATM address.

Specify the ATM address of the LES.

\*

**Note:** This command should be entered on one command line. It is shown here on two lines because of spacing.

**Example: set les-atm-address**

```
Ethernet IBM LEC Config> set les-atm-address  
39.84.0F.00.00.00.00.00.00.00.00.01.10.00.5A.00.DE.AD.02
```

### mac-address

Sets the MAC address for this LE client. You *may* specify that the client use the burned in MAC address, of the ATM interface, or you may specify a different MAC address. If you have two clients that are bridged together, they should use different MAC addresses.

**Valid Values:** Any valid MAC address.

**Default Value:** none

**Example: set mac-address**

```
Ethernet IBM LEC Config> set mac-address FF.FF.FF.FF.FF.FF.01
```

### mac-cache-size

Specifies the maximum number of MAC entries that the LEC caches.

Specify an integer number in the range 5 to 1024.

Default: 32

**Example: set mac-cache-size**

```
Ethernet IBM LEC Config> set mac-cache-size 48
```

### mac-cache-aging-period

Specifies the amount of time (in seconds) after which MAC addresses are aged out of the cache, if not refreshed.

Specify an integer number of seconds in the range 1 to 300.

Default: 60 seconds

**Example: set mac-cache-aging-period**

```
Ethernet IBM LEC Config> set mac-cache-aging-period 120
```

### rd-cache-size

Specifies the maximum number of route descriptor entries that the LEC caches.

Specify an integer number in the range 5 to 1024.

Default: 32

**Example: set rd-cache-size 48**

```
Ethernet IBM LEC Config> set rd-cache-size 48
```

### rd-cache-aging-count

Specifies the amount of time (in seconds) after which entries are aged out of the route descriptor cache, if not refreshed.

Specify an integer number of seconds in the range 1 to 300.

Default: 60 seconds

**Example: set rd-cache-aging-period**

```
Ethernet IBM LEC Config> set rd-cache-aging-period 120
```

**registration-interval**

Specifies the frequency (in seconds) that the LEC sends registration messages to the LES.

Specify an integer number of seconds in the range 30 to 240.

Default: 60 seconds

**Example: set registration-interval**

```
Ethernet IBM LEC Config> set registration-interval 75
```

**retry-count**

Sets the retry count. This is maximum number of times that the LEC retries an LE\_ARP\_REQUEST for a specific frame's LAN destination.

**Valid Values:** An integer number in the range of 2 to 10.

**Default Value:** 3

**Example: set retry-count**

```
Ethernet IBM LEC Config> set retry-count 2
```

**selector**

Specifies the selector portion of the client's ATM address. The combination of ESI and selector must be unique among all LANE components on the MSS Server. By default, a unique selector is selected for the configured ESI.

**Valid Values:** Any octet, in hexadecimal, that is not in use by another LANE component with the same ESI.

**Example: set selector**

```
LEC Config> set selector 01
```

## IBM LE Client Config>

trace

Sets packet trace for the LEC.

**Valid Values:** Enable or Disable

**Default Value:** Disable

To perform packet tracing, three steps are required:

1. Enable packet tracing system (under ELS)
2. Enable tracing on the LEC subsystem (under ELS)
3. Enable packet tracing on the desired LECs (using this command).

**Example:** Token Ring LEC config>**set trace**

Trace packets on the LEC? [No]?**yes**

## Exit

Use the **exit** command to return to the LE Client Config> prompt.

---

## Chapter 22. Monitoring LAN Emulation Clients

This chapter describes how to monitor LAN Emulation Clients (LECs). It includes the following sections:

- “Accessing the LEC Console Environment”
- “LEC Console Commands” on page 22-2

---

### Accessing the LEC Console Environment

Use the following procedure to access the LEC console commands. This process gives you access to the LEC *monitoring* process.

1. At the OPCON prompt, enter **talk 5**. (For more detail on this command, refer to Chapter 5, “The OPCON Process and Commands.”) For example:

```
* talk 5
+
```

After you enter the **talk 5** command, the GWCON prompt (+) displays on the console. If the prompt does not appear when you first enter configuration, press **Return** again.

2. At the + prompt, enter the **network** command to display the network interface numbers for which the router is currently configured, and enter the *interface number* for the LEC you wish to monitor. For example:

**Example: network**

```
+ network

1 : ATM Ethernet LAN Emulation: ETH
2 : IP Protocol Network
3 : Bridge Application
5 : CHARM ATM Adapter
Network number [0]? 1
LEC+
```

The LEC monitoring prompt (LEC+ ), is displayed.

If you know the interface number of the LEC you wish to monitor, enter the **network** command followed by the *interface number* of the LEC.

```
+ network 1
LEC+
```

## LEC Console Commands

This section summarizes and then explains the LEC console commands. You can access LEC console commands at the LEC+ prompt. Table 22-1 shows the commands.

<i>Table 22-1. LE Config Console Command Summary</i>	
<b>Command</b>	<b>Function</b>
<b>? (Help)</b>	Lists the LEC console commands or lists the options associated with specific commands.
<b>List</b>	Lists: <ul style="list-style-type: none"> <li>• LEC Address Resolution Table (ARP)</li> <li>• LEC configuration</li> <li>• Data Direct VCC information</li> <li>• LEC statistics.</li> </ul>
<b>MIB</b>	Displays LEC MIB objects including: <ul style="list-style-type: none"> <li>• LEC MIB Configuration Table</li> <li>• LEC MAC ARP Table</li> <li>• LEC Route Descriptor Table</li> <li>• LEC MIB Server VCC Tables</li> <li>• LEC MIB Statistics Table</li> <li>• LEC MIB Status Table</li> </ul>
<b>QoS</b>	Gets you to the LEC x QoS+ prompt from which you can monitor Quality of Service as described in “Quality of Service (QoS) Console Commands” on page 17-1.
<b>Exit</b>	Exits the LEC console process.

### ? (Help)

Use the **? (help)** command to list the commands that are available from the current prompt level. You can also enter a ? after a specific command name to list its options.

**Syntax:** ?

**Example:** ?

### List

Use the **list** command to list the LEC Address Resolution Table (ART), list the LEC configuration, list Data Direct VCC information, or list LEC statistics.

**Syntax:** list      arp  
                                  configuration  
                                  data  
                                  statistics

arp

Lists the LEC Address Resolution Table (ART).



**Example: list arp**

LEC+ list arp

## LEC Address Resolution Table

Max Table Size	= 10	Total # of entries
Free Table Entries	= 10	# of free entries.
Current Mac Entries	= 0	MAC - ATM entries
Current RD Entries	= 0	RD - ATM entries
Arp Aging Time	= 300	Time for an entry to be 'aged' out
Verify Sweep Interval	= 60	Table updated/verified every 60 seconds

## configuration

Lists the LEC configuration.

For Ethernet:

**Example: list config**

LEC+ list config

## ATM LEC Configuration

ATM interface number	= 0
LEC interface number	= 1
LECS auto configuration	= No
C1: Primary ATM address	
ESI address	= Use burned in addr
Selector byte	= 3
C2: Emulated LAN type	= Ethernet
C3: Maximum frame size	= 1516
C5: Emulated LAN name	=
C6: LE Client MAC address	= Use burned in addr
C7: Control timeout	= 120
C9: LE Server ATM address	= 39.84.0F.00.00.00.00.00.00.00.01.10.00.5A.00.DE.AD.02
C10: Maximum unknown count	= 1
C11: Maximum unknown time	= 1
C12: VCC timeout period	= 1200
C13: Maximum retry count	= 1
C17: Aging time	= 300
C18: Forward delay time	= 15
C20: LE ARP response time	= 1
C21: Flush timeout	= 4
C22: Path switch delay	= 6
C24: Multicast send VCC type	= Best-Effort
C25: Multicast send VCC avg rate	= 155000000
C26: Multicast send VCC peak rate	= 155000000
C28: Connection completion timer	= 4
LE ARP queue depth	= 10
LE ARP cache size	= 10
Best effort peak rate	= 155000
Maximum config retries	= 3

For Token Ring:

## Example: list config

LEC+list config

```
ATM LEC Configuration

ATM interface number      = 0
LEC interface number     = 1
LECS auto configuration  = No

C1: Primary ATM address
  ESI address             = Use burned in addr
  Selector byte          = 2
C2: Emulated LAN type    = Token Ring
C3: Maximum frame size   = 4544
C5: Emulated LAN name    =
C6: LE Client MAC address = 10.00.5A.11.11.11
C7: Control timeout      = 120
C9: LE Server ATM address = 39.84.0F.00.00.00.00.00.00.00.01.10.00.5A.00.DE.AD.02
C10: Maximum unknown count = 1
C11: Maximum unknown time = 1
C12: VCC timeout period  = 1200
C13: Maximum retry count = 1
C17: Aging time          = 300
C18: Forward delay time  = 15
C20: LE ARP response time = 1
C21: Flush timeout       = 4
C22: Path switch delay   = 6
C24: Multicast send VCC type = Best-Effort
C25: Multicast send VCC avg rate = 155000
C26: Multicast send VCC peak rate = 155000
C28: Connection completion timer = 4

LE ARP queue depth       = 10
LE ARP cache size        = 36920
Best effort peak rate    = 155000
Maximum config retries   = 999
Packet trace             = Yes
RIF Aging Timer          = 120
Source Routing           = Enabled
IPX interface configuration record missing
```

data

Lists the LEC Data Direct VCC information.

## Example: list data

LEC+ list data

```
LEC Data Direct VCC Table

Max Table Size      = 20      Max no of SVC connections
Current Size        = 0       Currently used
Max Conn Handles    = 512
Inactivity Timeout  = 1200    No Data Xfer Timeout before connection is
                                closed (seconds)
Sweep Interval      = 60      Time interval for activity check
```

statistics

Lists LEC statistics.

## Example: list statistics

LEC+ list stat

## LEC Statistics

In Octets.high	= 0	No of Bytes received
In Octets.low	= 346	
In Discards	= 2	Packets discarded
In Errors	= 0	Rx.Errors
In Unknown Protos	= 0	Unknown protocols received
Out Octets.high	= 0	No of Bytes xmitted.
Out Octets.low	= 0	
Out Discards	= 0	
Out Errors	= 0	Tx.Errors

## MIB

Use the **mib** command to display MIB objects.

**Note:** Some of this information may be displayed in a different format using the **list** command.

**Syntax:** mib      config  
                           mac  
                           rd  
                           server  
                           statistics  
                           status  
                           trace

config

Displays the LEC MIB Configuration Table.

**Example:** list mib config

LEC+ mib config

```
lecConfigTable:
lecConfigMode           = Manual
lecConfigLanType       = 802.3 - Ethernet
lecConfigMaxDataFrameSize = 1516
lecConfigLanName       =
lecConfigLesAtmAddress  = 39.84.0F.00.00.00.00.
lecControlTimeout      = 120
lecMaxUnknownFrameCount = 1
lecMaxUnknownFrameTime = 0
lecVccTimeoutPeriod    = 1200
lecMaxRetryCount       = 1
lecAgingTime           = 300
lecForwardDelayTime    = 15
lecExpectedArpResponseTime = 1
lecFlushTimeout        = 4
lecPathSwitchingDelay  = 6
lecLocalSegmentId      = 0
lecMulticastSendType   = 1
lecMulticastSendAvgRate = 155000000
lecMulticastSendPeakRate = 155000000
lecConnectionCompleteTimer = 4
```

*lecConfigMode*                      LEC config mode: AUTO or MANUAL. If AUTO, LEC Uses LECS to get the LES ATM address.

*lecConfigLanType*                    LAN type, either Ethernet or token-ring

*lecConfigMaxDataFrameSize*        Maximum frame size

## Monitoring LECs

<i>lecConfigLanName</i>	ELAN Name
<i>lecConfigLesAtmAddress</i>	LE Server ATM address
<i>lecControlTimeout</i>	Timeout for request/response control frame
<i>lecMaxUnknownFrameCount</i>	Maximum number of unknown frames
<i>lecMaxUnknownFrameTime</i>	Period in which LEC will send a maximum of MaxUnknownFrameCount frames to the BUS for a given unicast LAN Destination, and it must also initiate the address resolution protocol to resolve that LAN Destination.
<i>lecVccTimeoutPeriod</i>	Inactivity timeout of SVC Data Direct VCCs
<i>lecMaxRetryCount</i>	LE ARP retry count
<i>lecAgingTime</i>	Life of unverified entry in the ARP table
<i>lecForwardDelayTime</i>	
<i>lecExpectedArpResponseTime</i>	ARP Request/Response cycle time
<i>lecFlushTimeout</i>	LE Flush Request/Flush Reply timeout period
<i>lecPathSwitchingDelay</i>	
<i>lecLocalSegmentId</i>	Segment ID of emulated LAN. Only for 802.5 clients
<i>lecMulticastSendType</i>	Signaling parameter used by LEC for multicast send VCC
<i>lecMulticastSendAvgRate</i>	Signaling parameter used by LEC for multicast send VCC
<i>lecMulticastSendPeakRate</i>	Signaling parameter used by LEC for multicast send VCC
<i>lecConnectionCompleteTimer</i>	
mac	Displays the LEC MAC ARP Table
rd	Displays the LEC Route Descriptor Table
server	Displays the LEC MIB Server VCC Tables

**Example: mib server**

## LEC+ mib server

```

lecServerVccTable:
  lecConfigDirectInterface    = 0
  lecConfigDirectVpi         = 0
  lecConfigDirectVci         = 0
  lecControlDirectInterface   = 1
  lecControlDirectVpi        = 0
  lecControlDirectVci        = 38
  lecControlDistributeInterface = 1
  lecControlDistributeVpi    = 0
  lecControlDistributeVci    = 37
  lecMulticastSendInterface   = 1
  lecMulticastSendVpi        = 0
  lecMulticastSendVci        = 34
  lecMulticastForwardInterface = 1
  lecMulticastForwardVpi     = 0
  lecMulticastForwardVci     = 33

```

<i>lecConfigDirectInterface</i>	The interface associated with the Configuration Direct VCC
<i>lecConfigDirectVpi</i>	VPI which identifies the above VCC if it exists
<i>lecConfigDirectVci</i>	VCI which identifies the above VCC if it exists
<i>lecControlDirectInterface</i>	The interface associated with the Control Direct VCC
<i>lecControlDirectVpi</i>	VPI which identifies the above VCC if it exists
<i>lecControlDirectVci</i>	VCI which identifies the above VCC if it exists
<i>lecControlDistributeInterface</i>	The interface associated with the Control Distribute VCC
<i>lecControlDistributeVpi</i>	VPI which identifies the above VCC if it exists
<i>lecControlDistributeVci</i>	VCI which identifies the above VCC if it exists
<i>lecMulticastSendInterface</i>	The interface associated with the Multicast Send VCC
<i>lecMulticastSendVpi</i>	VPI which identifies the above VCC if it exists
<i>lecMulticastSendVci</i>	VCI which identifies the above VCC if it exists
<i>lecMulticastForwardInterface</i>	The interface associated with the Multicast Forward VCC
<i>lecMulticastForwardVpi</i>	VPI which identifies the above VCC if it exists
<i>lecMulticastForwardVci</i>	VCI which identifies the above VCC if it exists

## statistics

Displays the LEC MIB Statistics Table.

**Example: mib statistics**

## Monitoring LECs

### LEC+ mib statistics

```
lecStatisticsTable:
  lecArpRequestsOut      = 1
  lecArpRequestsIn      = 0
  lecArpRepliesOut      = 0
  lecArpRepliesIn       = 1
  lecControlFramesOut   = 2
  lecControlFramesIn    = 2
  lecSvcFailures        = 1

  In Frames              = 919
  Out Frames             = 917
  In Bytes               = 82698
  Out Bytes              = 82482
```

*lecArpRequestsOut* No. of LE ARP requests sent by this LEC

*lecArpRequestsIn* No. of LE ARP requests received by this LEC

*lecArpRepliesOut* No. of LE ARP responses sent by this LEC

*lecArpRepliesIn* No. of LE ARP responses received by this LEC

*lecControlFramesOut* No. of Control Packets sent by this LEC

*lecControlFramesIn* No. of Control Packets received by this LEC

*lecSvcFailures* The total number of:

- Outgoing LAN Emulation SVCs which this client tried but failed, to open
- Incoming LAN Emulation SVCs which this client tried, but failed to establish
- Incoming LAN Emulation SVCs which this client rejected for protocol or security reasons

### status

Lists MIB status.

#### Example: list mib status

##### LEC+ mib status

```
lecStatusTable:
  lecPrimaryAtmAddress      = 39.84.0F.00.00.00
  Client ATM address=      = 00.00.00.00.00.01.10.00.5A.00.DE.AD.03
  lecId                     = 1                      Assigned by LES
  lecInterfaceState        = Operational          State of the LEC
  lecLastFailureRespCode   = None                    Error code from last
  lecLastFailureState      = Initial State          failed Config/Join resp.
  lecProtocol               = 1                      State of LEC when
  lecVersion                = 1                      updating above field.
  lecTopologyChange        = False                    Protocol specified by
  lecConfigServerAtmAddress = 00.00.00.00.00.00.    LEC in Join requests.
  ATM Address of LECS      = 00.00.00.00.00.00.00.00.00.00.00.00.00.00
  lecConfigSource          = Did not use LECS        LEC Protocol Version
  lecActualLanType         = 802.3 - Ethernet      of above
  lecActualMaxDataFrameSize = 1516
```

lecActualLanName	= ETH	Name of emulated LAN that LEC joined.
lecActualLesAtmAddress	= 39.84.0F.00.00.00.	
ATM Address of LES	= 00.00.00.00.00.00.01.10.00.5A.00.DE.AD.02	
lecProxyClient	= False	Is LES acting like a proxy ?

trace

**Example: trace on or off or list**

## QoS Information

Use the **qos-information** command to get to the LEC x QoS+ prompt from which you can monitor Quality of Service as described in “Quality of Service (QoS) Console Commands” on page 17-1.

**Syntax:** qos-information

**Example:** qos

## Exit

Use the **exit** command to return to the previous prompt level.

**Syntax:** exit

**Example:** exit





---

## Chapter 23. Configuring LAN Emulation Services

This chapter describes configuration of LAN Emulation Services for an Emulated LAN (ELAN). It includes the following sections:

- “About LAN Emulation Services”
- “Accessing the LAN Emulation Services Environment”
- “Configuring a LES-BUS” on page 23-4
- “Commands for Configuring a LECS” on page 23-15
- “Configuring ELANs at the LECS” on page 23-20
- “Detailed Configuration of an ELAN at the LECS” on page 23-23
- “Configuring the Policies of a LECS” on page 23-33
- “Configuring Security for ELANs” on page 23-36

---

### About LAN Emulation Services

LAN Emulation (LE) protocols allow ATM networks to appear as Local Area Networks such as Ethernet or Token-Ring. An emulated LAN (ELAN) provides flexibility in handling moves, adds, and changes to your network topology. A client's association with an ELAN is logical and is independent of physical location. Consequently, reconfiguration is not required when a station is physically moved, provided the station's ELAN *membership* is retained. A station can be a member of multiple ELANs. Wiring modifications are not required when a station is moved from one ELAN to another.

An ELAN is a collection of LAN Emulation Clients (LECs) that are coordinated by Lan Emulation (LE) Services. There are three standard LE Services components that provide services for your ELANs:

- LE Server (LES)
- Broadcast and Unknown Server (BUS)
- LE Configuration Server (LECS)

This chapter specifically describes configuration of the LES, BUS, and LECS components. For a description of LAN Emulation Client (LEC, not to be confused with LECS), refer to Chapter 21, “Using and Configuring LAN Emulation Clients” on page 21-1.

The MSS Server has an additional LE Services component that provides a value-added security feature to LE Services. For additional detail on this security feature and on the overall LAN Emulation environment, refer to the *Multiprotocol Switched Services (MSS) Server Configuration and Operations Guide*.

---

### Accessing the LAN Emulation Services Environment

This section serves primarily as a directory that points to descriptions of LE-Services configuration commands in other sections of this chapter.

To get to the LE-services environment, enter the **le-s** command at the ATM config> prompt:

```
ATM config> le-s
LAN Emulation Services user configuration
LE Services config>
```

## Accessing LAN Emulation Services

To start the configuration process, enter the following commands at the LE Services config> prompt:

Command	Function
<b>Lecs</b>	Enters the LECS Configuration environment. For additional information, see “Commands for Configuring a LECS” on page 23-15.
<b>Les-bus</b>	Enters the LES-BUS Configuration environment for a particular ELAN. For additional information, see “Configuring a LES-BUS” on page 23-4.
<b>List</b>	Lists all LES-BUSs that you have configured.
<b>Rename</b>	Changes the name of the LES-BUS.
<b>Security</b>	Enters the LES-LECS Security Interface Configuration environment. For additional information, see “Configuring Security for ELANs” on page 23-36.
<b>Exit</b>	Returns to the ATM config> prompt.

**Note:** For a description of addressing requirements in this environment, see “How to Enter Addresses” on page 19-1.

### Lecs

Type the **lecs** command at the LE Services config> prompt to enter the LECS Configuration environment. The LECS Configuration environment is characterized by the LECS config> prompt.

**Syntax:** lecs

**Example:**

```
LE Services config> lecs
LAN Emulation Configuration Server configuration
LECS config>
```

For additional information, see “Commands for Configuring a LECS” on page 23-15.

### Les-bus

Type the **les-bus** command at the LE Services config> prompt to enter the LES-BUS Configuration environment for a particular LES-BUS. You will be prompted for the name of the ELAN served by the LES-BUS. The LES-BUS Configuration environment is characterized by the LES-BUS Config for ELAN 'n'> prompt.

**Syntax:** les-bus

**Example:**

```
LE Services config> les-bus
ELAN Name (ELANxx) [ ]?e1an01
LES-BUS configuration
LES-BUS Config for ELAN 'e1an01'>
```

For additional information, see “Configuring a LES-BUS” on page 23-4.

## List

Enter the **list** command to display a list of all the ELANS that are served by LES-BUSs configured on the MSS Server.

**Syntax:** `list`

**Example:**

```
LE Services config>list
List of Configured LES-BUS(s)

ELAN Type (E=Ethernet/802.3, T=Token Ring/802.5)
| Interface
| | Enabled
| | |
| | | Max.
| | | Frame Re
| | | ncy
| | | ELAN Name          LES ESI      Sel  Size  Ro
| | | -----
| | | T 0 Y Test Token Ring Elan      (burned in)  x02   4544  (d
| | | E 0 Y Test Ethernet Elan      (burned in)  x03   1516  (d
```

## Rename

Enter the **rename** command to change the name of a LES/BUS.

**Note:** If you rename a LES/BUS, you **must** reload the configuration in order for the name change to occur. Restarting the OPCON interface will not update the name.

**Syntax:** `rename`

**Example:**

```
LE Services config> rename
Existing ELAN Name --? test
New ELAN Name --? newtest
```

## Security

Type the **security** command to enter the LES-LECS Security Interface Configuration environment. This environment is characterized by the the LECS INTERFACE config> prompt.

**Syntax:** `security`

**Example:**

```
LE Service config> security
LECS Interface configuration
LECS INTERFACE config>
```

For additional information, see “Configuring Security for ELANS” on page 23-36.

## Exit

Use the **exit** command to return to the ATM config> prompt.

**Syntax:** `exit`

**Example:** `exit`

### Configuring a LES-BUS

This section describes the commands for configuring a LES-BUS pair. Enter the **les-bus** command at the LE Services config> prompt:

```
LE Services config> les-bus
ELAN Name (ELANxx) [ ]?
```

Enter the name of either a new or an existing ELAN:

```
ELAN Name (ELANxx) [ ]?e1an01
LES-BUS config for ELAN 'e1an01'>
```

You can enter the following commands:

Command	Function
<b>Add</b>	Adds a LES-BUS to a local configuration.
<b>Disable</b>	Disables Broadcast Manager, BUS-Monitor, LES-BUS, Redundancy, or Source Route Manager.
<b>Enable</b>	Enables Broadcast Manager, BUS-Monitor, LES-BUS, Redundancy, or Source Route Manager.
<b>List</b>	Lists a LES-BUS' operational characteristics.
<b>Remove</b>	Removes Broadcast Static Entries or LES-BUS.
<b>Set</b>	Sets operational characteristics.
<b>Exit</b>	Returns to the LE Services config> prompt.

## Add

Use the **add** command to specify this LES-BUS' type, ESI, and selector.

Each LES-BUS must have a unique ELAN name, and the combination of ESI and selector must be unique among all LE components.

**Syntax:** `add`

**Example:**

```
LES-BUS config for ELAN 'e1an01'> add
Select ELAN type
  (1) Token Ring
  (2) Ethernet

Enter Selection: [1]1
Select ESI
  (1) Use burned in ESI

Enter Selection: [1]?1
```

Selector 0 is generally reserved for use by the LECS,  
Selector 1 is generally reserved for use by the LECS interface.

```
Enter selector [4]?4
Selection "Add LES-BUS" Complete
LES-BUS config for ELAN 'e1an01'>
```

## Disable

Use the **disable** command to disable Broadcast Manager, BUS-Monitor, LES-BUS, Redundancy, or Source Route Manager.

**Syntax:** `disable broadcast-manager ...`  
`bus-monitor`  
`les-bus`  
`redundancy`  
`source`

`broadcast manager all, or ip, or ipx, or netbios`

Disables broadcast manager for this ELAN. Broadcast manager is an IBM enhancement to the BUS that reduces broadcast traffic by transforming certain broadcast frames into unicast frames. See “Broadcast Manager (BCM)” on page 18-14 for additional information about Broadcast manager. You can disable broadcast manager for all protocols, or for a specific protocol.

**Example:** `disable broadcast-manager ipx`

`bus-monitor`

Disables BUS Monitor for this ELAN. BUS Monitor is an IBM enhancement to the BUS that monitors BUS traffic to identify those stations generating the most BUS traffic. See “BUS Monitor” on page 18-18 for additional information.

`Les-bus`

Disables LES-BUS for this ELAN. This LES-BUS will not activate on the next restart of the router.

`Redundancy`

Disables redundancy for this ELAN. Redundancy is an IBM enhancement to the LES-BUS that allows each LES-BUS to have a backup that will activate only if the primary LES-BUS fails. See “LAN Emulation Reliability” on page 18-15 for additional information.

`Source route management`

Disables source route management (SRM) for this ELAN. SRM can transform spanning tree explorer and all routes explorer packets into specifically routed frames. SRM operates only on those frames managed by BCM. See “BCM Support for Source Route Bridging” on page 18-15 for additional information.

## Enable

Use the **enable** command to enable Broadcast Manager, BUS-Monitor, LES-BUS, Redundancy, or Source Route Management.

**Syntax:** `enable broadcast-manager ...`  
`bus-monitor`  
`les-bus`  
`redundancy`  
`source`

`broadcast manager all or ip or ipx or netbios`

Enables all (or individual) protocols for Broadcast Manager. Broadcast manager is an IBM enhancement to the BUS that reduces broadcast traffic by transforming certain broadcast frames into unicast frames. See “Broadcast Manager (BCM)” on page 18-14 for additional information about Broadcast manager. You can enable broadcast manager for all protocols, or for a specific protocol.



## Example:

```

LES-BUS config for ELAN 'elan01'> list
LES-BUS Detailed Configuration
Name: elan01
  LES-BUS Enabled/Disabled:           Enabled
  ATM Device number:                 0
  End System Identifier (ESI):        Use Burned in ESI
  Selector Byte:                      0x04
  ELAN Type: (S2)                    Ethernet
  Max Frame Size: (S3)                1516
  Control Timeout: (S4)               120
  Max Frame Age: (S5)                 1
  LECID Range Minimum:                1
  LECID Range Maximum:                65279
  Validate Best Effort Peak Cell Rate (PCR): No
  Control Distribute VCC Traffic Type: Best Effort VCC
  Control Distribute VCC PCR in Kbps: 155000
  Control Direct VCC Max Reserved Bandwidth: 0
  Multicast Forward VCC Traffic Type: Best Effort VCC
  Multicast Forward VCC PCR in Kbps: 155000
  Multicast Send VCC MAX Reserved Bandwidth: 0

  -LES-BUS Options-
  BUS mode:                           Adapter
  Security (LECS Validation of Joins): Disabled
  Partition LE_ARP_REQUEST Forwarding Domain: Yes
  LE_ARP RESPONSE Destination:        One client
  Partition Unicast Frame Domain:      Yes
  Redundancy:                           Disabled
  ATM address trace filter value: 0000000000000000000000000000000000000000000000000000000000000000
  ATM address trace filter mask: ffffffffffffffffffffffffffffffffffffffffffffffffffffffffffffffffffffff

  -BUS Monitor Configuration-
  Monitor Host Usage of BUS:           Disabled
  # Top Hosts to Record:                10
  # Seconds in each sample interval:    10
  # Minutes between sample intervals:   30
  Frame sampling rate:                  1 out of 10

  -Broadcast Manager Configuration-
  IP BCM:                               Disabled
  IPX BCM:                              Disabled
  NetBIOS BCM:                          Disabled
  IPX BCM Active Forwarding List Size: 0
  BCM IP Cache Aging Time:              5
  BCM IPX Cache Aging Time:             3
  BCM NetBIOS Cache Aging Time:        15
  Token Ring Source Route Management:   Disabled
  BCM IPX Maximum Forwarding List:      50
  No BCM IPX Static Entries defined
LES-BUS config for ELAN 'elan01'>

```

## Remove

Use the **remove** command to remove broadcast static entries or a LES-BUS pair.

**Syntax:** `remove broadcast`  
`les-bus`

`broadcast`

Removes static entries defined for IPX Broadcast Manager.

`les-bus`

Deletes the LES-BUS configuration.

## Configuring a LES-BUS

### Example: remove broadcast

```
Choose static entry to delete
(1) 00000000000000000000000000000001/FFFFFFFF
(2) 00000000000000000000000000000002/000000000001
(3) 00000000000000000000000000000003/000000000003

Enter Selection: [1]? 2
Selection "Remove BCM Static Entry" Complete
LES-BUS config for ELAN 'elan01'>
```

## Set

Use the **set** command to set operational characteristics associated with this ELAN.

**Syntax** set address  
broadcast  
bus-mode  
bus-monitor  
control  
frame-age  
frame-size  
ip  
ipx-broadcast  
ipx-maximum  
le arp  
LECID Range  
netbios  
partition  
security  
trace  
traffic

### address

Specifies the End System Identifier (ESI) and selector components of the LES-BUS's ATM address. For more information on addressing in ATM and on the ATM address of the LE components on the server see "Addressing in ATM" on page 18-3 and "ATM Addresses of LAN Emulation Components" on page 18-4.

### Example: set address

```
Select ESI
(1) Use burned in ESI

Enter Selection: [1]?1
Selector 0 is generally reserved for use by the LECS,
Selector 1 is generally reserved for use by the LECS Interface.

Enter selector [7]?7
Selection "Set Address" Complete
LES-BUS config for ELAN 'elan01'>
```

### broadcast

Defines static entries for IPX Broadcast Manager (BCM). IPX BCM dynamically discovers IPX routers and servers in the IPX network containing this ELAN by monitoring traffic sent to the BUS for IPX advertisements.

Any device that requires reception of IPX advertisements that does not transmit advertisements must be configured as a Static Target. An example would be a station running software that discovers IPX network topology by monitoring IPX advertisements. Broadcast Manager for IPX is not aware of this "quiet" station



without a Static Target definition of its MAC address and the address of the representing LEC.

A Static Target also can be used effectively when many IPX Routers and Servers are represented by a single LEC. By configuring a Static Target with the ATM address of the LEC, but with a broadcast MAC address of all Fs, all IPX Routers and Servers behind the LEC receive a single broadcast advertisement rather than multiple unicast advertisements.

### **Example: set broadcast**

```
Enter ATM address in 00.00.00.. form [ ]? 00.00.00.00.00.00.00.00.00.00.00.00.01
Enter MAC address in 00.00.00.. form [FF.FF.FF.FF.FF.FF]?FF.FF.FF.FF.FF.FF
Selection "Set Broadcast Static Entry" Complete
LES-BUS config for ELAN 'elan01'>
```

#### *bus-mode mode*

Sets the bus mode for this LES-BUS. The different modes trade intelligence for increased forwarding speed of the LES-BUS. The modes are:

#### **System**

All BUS features are available and may be enabled or disabled. Frames received by the BUS are moved into system memory for analysis before transmission.

#### **Adapter**

Frames received for the BUS are not moved into system memory but remain on the ATM adapter until transmitted. If the ELAN is operational in this mode, the Broadcast Manager and Source Route Management are unavailable and cannot be enabled.

All BUS frames for token-ring ELANs are counted as multicast frames.

#### **VCC-Splice**

The client's multicast send VCC to the BUS is "spliced" to the multicast forward VCC allowing the ATM adapter to transmit received frames from one VCC to its spliced VCC pair without notifying the system processor. Statistics maintained by the BUS are unreliable because the BUS does not process all frames.

#### **Notes:**

1. Unicast partitioning must be disabled to set the BUS mode to VCC-Splice.
2. If the ELAN is operational in this mode, the Broadcast Manager and Source Route Management are unavailable and cannot be enabled.
3. BUSMON is unavailable in VCC-Splice mode.

**Default value:** Adapter.

#### *bus-monitor settings*

Specifies sample interval, sampling rate, inter-sample sampling time, and the number of MAC addresses to record for BUS Monitoring. For more information on BUS monitor, see "BUS Monitor" on page 18-18. The BUS Monitor parameters control how often BUS Monitor samples frames. More frequent sampling leads to more accurate results, but also requires more processing time at the BUS.

### **Example: set bus-monitor duration**

## Configuring a LES-BUS

```
Duration of sample interval in seconds (1-600) [10]?10
Selection "Set BUS monitoring sample interval" Complete
LES-BUS config for ELAN 'elan01'>
```

### Example: set bus-monitor sample

A value of 10 means 1 out of every 10 frames is sampled.

```
Frame sampling rate (1-1000) [10]?10
Selection "Set the sampling rate" Complete
LES-BUS config for ELAN 'elan01'>
```

### Example: set bus-monitor time

```
Number of minutes between sample intervals (1-120) [30]?15
Selection "Set BUS monitoring inter-sample time" Complete
LES-BUS config for ELAN 'elan01'>
```

### Example: set bus-monitor top

```
Number of top MAC addresses to record (1-100) [10]?10

Selection "Set number of top MAC addresses to record" Complete
LES-BUS config for ELAN 'elan01'>
```

## control

Sets the control timeout, in seconds, for the LE Server. This is the timeout used for many of the response/request exchanges. This parameter maps to the S4 parameter in the *ATM Forum LAN Emulation Over ATM Specification*. A smaller control timeout may lead to quicker response times, but may also lead to unnecessary retransmissions. This parameter should be coordinated with the control timeout of LE clients joining this LES.

### Example: set control

```
Control Timeout (10-300): [120]?120
Selection "Set Control Timeout" Complete
LES-BUS config for ELAN 'elan01'>
```

## frame-age

Sets maximum frame age. The BUS must discard a frame if it has not transmitted the frame to all relevant VCCs within the Maximum Frame Age following the BUS's receipt of the frame. This parameter maps to the S5 parameter in the *ATM Forum LAN Emulation Over ATM Specification*.

### Example: set frame-age

```
Maximum Frame Age (1-4): [1]?1
Selection "Set Maximum Frame Age" Complete
LES-BUS config for ELAN 'elan01'>
```

## frame-size

Sets maximum frame size. The maximum size of an AAL-5 Service Data Unit (SDU) that the LE Service can guarantee not to drop for being too large. Also the minimum AAI-5 SDU size that every LE Client must be able to receive. This parameter maps to the S3 parameter in the *ATM Forum LAN Emulation Over ATM Specification*.

### Example: set frame-size

```
Maximum Frame Size:
(1) 1516
(2) 4544
(3) 9234

Enter Selection: [2]?2
Selection "Set Maximum Frame Size" Complete
LES-BUS config for ELAN 'elan01'>
```

### *ip broadcast cache age*

Sets IP Broadcast cache age in minutes. This is the maximum number of minutes an IP entry will be kept without re-verification of its location.

**Example: set ip**

```
IP cache age in minutes (2-20): [5]?5
Selection "Set IP broadcast cache age" Complete
LES-BUS config for ELAN 'elan01'>
```

### *ipx broadcast cache age*

Sets IPX Broadcast cache age in minutes. This is the maximum number of minutes an IPX entry will be kept without re-verification of its location.

**Example: set ipx-broadcast**

```
IPX cache age in minutes (1-10): [3]?3
Selection "Set IPX broadcast cache age" Complete
LES-BUS config for ELAN 'elan01'>
```

### *ipx maximum size of forwarding list*

Sets the maximum number of entries that BCM IPX will maintain in its Forwarding List.

**Note:** This parameter puts an upper limit of the device's performance, so use caution when increasing this limit. BCM IPX's Forwarding List consists of all the dynamically discovered IPX routers or servers in the IPX network containing this ELAN, as well as any BCM Static Targets currently active on the ELAN. For each broadcast frame managed by BCM IPX, the frame is individually transmitted to each member on the Forwarding List. If the number of members exceeds the maximum, BCM IPX automatically shuts down, allowing BUS to forward IPX broadcasts as usual.

**Example: set ipx-maximum**

```
IPX Maximum Size of Forwarding List (5-65535): [50]? 60
Selection "Set IPX Maximum Size of Forwarding List" Complete
```

### *le arp response destination*

Sets LE ARP response destination for either one or all clients. When ALL CLIENTS is selected, LE ARP Response frames initiated or forwarded by the LES are sent to all clients on the Control Distribute VCC(s). When ONE CLIENT is selected, LE ARP Response frames are sent only to the client that originated the LE ARP Request, over the Control Direct VCC to that client. The ALL CLIENTS option is most useful when LE Clients learn MAC/ATM addresses from LE ARPs which they did not originate. Many LE Clients do not learn LE ARPs which they did not originate.

**Example: set le arp**

```
LE ARP Response Destination
(1) One client
(2) All clients

Enter Selection: [1]?1
Selection "Set LE ARP Response Destination" Complete
LES-BUS config for ELAN 'elan01'>
```

### *LECID range*

Sets bounds on the range of LECIDs used by this LES. By configuring a LECID range, you can guarantee that all LESs within a Super ELAN use a disjoint set of LECIDs. Maintaining LECID uniqueness within a Super ELAN is required if any clients filter data-direct VCCs based on LECID, or if any clients do not implement the (C22) path switch delay timer.

## Configuring a LES-BUS

This parameter may also be used to limit the number of clients served by this LES-BUS.

### *netbios broadcast cache age*

Sets NetBIOS cache age in minutes. This is the maximum number of minutes an NetBIOS will be kept without re-verification of its location.

#### **Example: set netbios**

```
NetBIOS cache age in minutes (10-20): [15]?12
Selection "Set NetBIOS broadcast cache age" Complete
LES-BUS config for ELAN 'elan01'>
```

### *partition*

Partitions the *control distribute* or *multicast forward* VCCs.

Proxy clients are placed on one Control Distribute VCC and all other clients are placed on another Control Distribute VCC. Partitioning the VCCs reduces nuisance traffic at many clients because non-proxy LECs do not receive proxy LEC traffic, and vice-versa. However, each frame must now be forwarded on two VCCs. In general, partitioning the VCCs is recommended.

The **set partition address** command partitions the control distribute VCC into a “proxy control distribute” VCC and a “non-proxy control distribute” VCC.

#### **Example: set partition address**

```
Partition address resolution forwarding domain [yes]yes
Selection "Partition address resolution forwarding domain" Complete
LES-BUS config for ELAN 'elan01'>
```

The **set partition unicast** command partitions the multicast forward VCC into a “proxy multicast forward” and a “non-proxy multicast forward” VCC.

#### **Example: set partition unicast**

```
Partition unicast frame forwarding domain [yes]?no
Selection "Partition unicast frame domain" Complete
LES-BUS config for ELAN 'elan01'>
```

### *security*

Enables LECS validation of joins. If enabled, the LES-BUS communicates with the LECS across the LES-LECS Security Interface in order to validate each LE Client’s request to join the ELAN. The LES-LECS Security Interface for this ATM Interface must be enabled (see “Configuring Security for ELANs” on page 23-36).

#### **Example: set security**

```
Enable Security (LECS validation of Joins) [no]yes
Selection "Enable Security (LECS Validation of Joins)" Complete
LES-BUS config for ELAN 'elan01'>
```

### *trace mask or value*

Sets trace filter mask or trace filter value for ATM address. For each VCC, if the ATM address of the entity at the other end of the VCC matches the ATM-address-value on all bits set by the ATM-address-mask, then packet tracing *may* be performed on that VCC. For packet tracing to occur, enable it in the ELS subsystem (for additional information, refer to Chapter 11, “Using and Configuring the Event Logging System (ELS)” on page 11-1).

#### **Example: set trace mask**

```
ATM address trace filter mask in 00.00.00.. form FF:—FF[ ]?
Selection "Set ATM address trace filter mask" Complete
```

**Example: set trace value**

```
LES-BUS config for ELAN 'elan01'> set packet value
ATM address trace filter value in 00.00.00.. form
00.00.00.00.00.00.00.00.00.00.00.00.00.00.00.00.00.00.00.00 [ ]?
```

**Note:** The previous two lines are displayed as one line.

traffic ...

Sets traffic characteristics:

- *set traffic control* sets traffic characteristics of the “control distribute” VCC.

**Example: set traffic control**

```
Traffic type
(1) Best Effort
(2) Reserved Bandwidth

Enter Selection: [1:]?1

Peak cell rate in Kbps (1 - 155000) [155000]?155000

Selection "Set Control distribute VCC" Complete
LES-BUS config for ELAN 'elan01'>
```

- *set traffic maximum control* or *set traffic maximum multicast* sets the maximum reserved bandwidth allowed either on control direct or on multicast send reserved bandwidth VCCs. Reserved bandwidth VCCs with requested bandwidth higher than the maximum specified by this command are rejected.

**Example: set traffic maximum control**

```
Maximum reserved bandwidth in Kbps (0 - 155000) [0]?100000
Selection "Set Control Direct VCC maximum reserved bandwidth" Complete
LES-BUS config for ELAN 'elan01'>
```

- *set traffic multicast* sets traffic characteristics of the multicast forward VCC.

**Example: set traffic multicast**

```
Traffic type
(1) Best Effort
(2) Reserved Bandwidth

Enter Selection: [1]?1

Peak cell rate in Kbps (1 - 155000) 155000 [ ]?90000

Selection "Set Multicast Forward VCC" Complete
LES-BUS config for ELAN 'elan01'>
```

- *set traffic validate* determines whether the LES-BUS is to validate the peak cell rate specified on incoming control direct or multicast send VCCs. When you specify this command, the LES-BUS rejects all control direct or multicast send VCCs that specify a peak cell rate that is greater than the maximum data rate of the ATM interface.

**Example: set traffic validate**

```
Validate peak cell rate of best effort VCCs [no]no
Selection "Validate Peak Cell Rate of best effort VCCs" Complete
LES-BUS config for ELAN 'elan01'>
```

## Configuring a LES-BUS

### Exit

Use the **exit** command to return to the LES-BUS config for ELAN 'elan01'> prompt.

**Syntax:** exit

**Example:** exit

## Commands for Configuring a LECS

Enter the **lecs** command at the LE Services `config>` prompt to enter the LECS `config>` environment where you initiate configuration for the individual ELANS for your network.

Table 23-3. LECS Configuration Commands Summary

Command	Function
<b>Add</b>	Adds a LECS to the static configuration of the ATM network.
<b>Elans</b>	Configures the ELANS under the administrative domain of the LECS.
<b>List</b>	Lists the configuration of the LECS on the MSS Server.
<b>Policies</b>	Configures the policies guiding this LECS.
<b>Remove</b>	Removes the LECS from the static configuration of the ATM network.
<b>Search</b>	Lets you use “search keys” to simplify configuration management.
<b>Set</b>	Sets operational characteristics of the LECS.
<b>Exit</b>	Returns to the LE Services <code>config&gt;</code> prompt.

### Add

The **add** command adds a LECS to your ATM network. Adds a LECS to the static configuration of the MSS Server. You are prompted to select the ESI to be used in the ATM address of the LECS. You are also asked to select whether to activate error logging on the LECS subsystem. For further information on error logging, refer to “ELS Configuration Commands” on page 11-7.

**Syntax:** `add`

**Example:**

```
LECS config> add
( 1) Use burned in ESI
End system identifier [1]?yes
LECS added to configuration
Enable standard Error Logging System for LECS? [Yes] Y
Standard ELS activated for LECS
LECS config>
```

### Elans

Type the **elans** command to enter the LECS ELANS Configuration environment. In this environment, you configure all ELANS under the administrative domain of the LECS. This environment is characterized by the LECS `ELANS config>` prompt.

**Syntax:** `elans`

**Example:**

```
LECS config> elans
Configuration of ELANS for LECS
LECS ELANS config>
```

## Configuring a LECS

For a description of commands used in the LECS ELANS config> environment, see “Configuring ELANs at the LECS” on page 23-20.

### List

The **list** command displays the configuration of the LECS. The various configuration parameters are described under “Set” on page 23-17.

**Syntax:** `list`

**Example:**

```
LECS config> list
LECS Detailed Configuration
  Lecs is                               Enabled
  ATM Device number:                     0
  ESI:                                    Use Burned in ESI
  Selector:                               0
  Validate Best Effort PCR:               No
  Configuration Direct Max Reserved BW (Kbps): 0
  Maximum number of simultaneous VCCs:    128
  Idle VCC Timeout (in seconds):          60
  Trace ATM address value:                00.00.00.00.00.00.00.00.00.00.00.00.00.00.00.00.00
  Trace ATM address mask:                 FF:-----FF
LECS config>
```

### Policies

The **policies** command puts you in the LECS Policies Configuration environment. In this environment, you configure the policies used to guide the LECS operation. The LECS Policies Configuration environment is characterized by the LECS Policies config> prompt.

**Syntax:** `policies`

**Example:**

```
LECS config> policies
LECS Policies config>
```

For additional information, see “Configuring the Policies of a LECS” on page 23-33.

### Remove

The **remove** command removes the LECS from the static configuration of the MSS Server. You are prompted whether to remove all other LECS objects (for example, policies and ELANs) from the static configuration also.

**Syntax:** `remove`

**Example:**

```
LECS config> remove
Remove all ELAN and policy information for this LECS [yes]yes
Removed policies and ELANs for LECS
LECS removed
Selection "LAN Emulation Configuration Server (LECS) remove" Complete
LECS config>
```



## Search

The **search** command provides “search keys” to simplify configuration management. Each search key represents some unique aspect of LE Servers or LE Clients (ATM address, MAC address, name of ELAN, etc.). Search keys can be used to determine which ELAN a particular LES is serving, or to which LES a certain policy value is assigned.

**Syntax:** search    atm  
                           les  
                           mac  
                           name  
                           route

**Example: search mac**

```
LECS config> search mac
Enter MAC address using its natural bit-order
MAC address to search for [ ]?11.11.11.11.11.11
MAC address 11.11.11.11.11.11
   for LES 00.00.00.00.00.00.00.00.00.00.00.00.00.00.00.00.00
   for ELAN 'lgrove01'
LECS config>
```

## Set

The **set** command lets you change the operational characteristics of the LECS.

**Syntax:** set            address  
                               enable-disable  
                               maximum  
                               reserved  
                               trace  
                               validate  
                               vcc

**Example:**

```
LECS config> set address
End system identifier
   (1) Use burned in ESI

Enter Selection: [1]?
Selector 0 is generally reserved for the LECS and
selector 1 is generally reserved for the LECS interface.
Selector [0]?4
Selector of LECS' ATM address is 4
Selection "LECS address modification" Complete
LECS cofig>
```

### Address

Changes the address of the LECS. This is the local ATM address of the LECS. At the ATM switches, you may also configure the well-known LECS address to be associated with this local ATM address. See “Addressing in ATM” on page 18-3 for additional information about addressing.

### Enable/Disable

Enables or disables the LECS. If the LECS is disabled, it will not be started the next time the router is restarted.

### Maximum number of VCCs

Maximum number of configuration direct VCCs that the LECS supports at one time. If the actual number of VCCs to the LECS exceeds this number, the

## Configuring a LECS

LECS releases *all* VCCs that have not been used in the number of seconds specified by the VCC idle time (described below).

### Reserved bandwidth maximum

Maximum bandwidth (in Kbps) that the LECS accepts on any reserved bandwidth configuration direct VCC.

### Trace *value* or *mask*

Each LE component supports packet tracing. You can specify an ATM address filter for packet tracing. For each VCC, if the ATM address of the entity at the other end of the VCC matches the ATM-address-value on all bits set by the ATM-address-mask, then packet tracing *may* be performed on that VCC. For packet tracing to occur, enable it in the ELS subsystem (for additional information, refer to Chapter 11, "Using and Configuring the Event Logging System (ELS)" on page 11-1.

### Validate best effort peak cell rate

Answer **yes** or **no**.

When you configure the LECS to validate best effort PCR, the peak cell rate (specified while setting up each VCC) is examined. If the peak cell rate is greater than the maximum data rate of the ATM interface, the requested VCC is rejected.

### VCC idle time

Number of seconds (of idle time) before LECS releases VCCs that have not been used when the number of VCCs exceeds the number that the LECS supports. (See also "Maximum number of VCCs" above.)

## Exit

Use the **exit** command to return to the LE Services config> prompt.

**Syntax:** exit

**Example:** **exit**

---

### Configuring ELANs at the LECS

The primary function of the LECS is to assign clients to LESs that serve ELANs. You enter commands at the LECS `ELANs config>` prompt to configure all of the ELANs under the administrative control of the LECS. Before *any* client for a particular ELAN can use this LECS, information on that ELAN must be configured on this LECS. Even if an ELAN is served by a local LES-BUS, the ELAN information must be configured here if the LECS is to refer any clients to that ELAN.

To configure ELANs under the administrative domain of the LECS, enter the **elans** command at the `LECS config>` prompt:

```
LECS config> elans
Configuration of ELANs for LECS
LECS ELANs config>
```

You can enter the following commands at the `LECS ELANs config>` prompt:

<i>Table 23-4. LECS ELANs Configuration Commands Summary</i>	
<b>Command</b>	<b>Function</b>
<b>Add</b>	Adds an ELAN to the static configuration of the LECS' administrative domain.
<b>List</b>	Summarizes the LECS' ELANs.
<b>Remove</b>	Removes an ELAN from the static configuration of the LECS' administrative domain.
<b>Select elan</b>	Selects an ELAN for more detailed configuration.
<b>Exit</b>	Returns to the <code>LECS config&gt;</code> prompt.

### Add

The **add** command adds an ELAN to the static configuration of the LECS' administrative domain. You will be prompted for the ELAN name, type, and maximum frame size.

**Syntax:** `add`

**Example:**

```
LECS ELANs config> add
Name of ELAN [ ]? cary02
Type of ELAN
(1) Ethernet
(2) TokenRing

Enter Selection: [2]? 2
Maximum frame size of ELAN
(1) 1516
(2) 4544
(3) 9234
(4) 18190

Enter Selection: [2]? 2
ELAN 'cary02' added
Selection "ELAN addition" complete
LECS ELANs config>
```

## List

The **list** command summarizes the ELANs under the administrative domain of the LECS.

**Syntax:** `list`

**Example:**

```
LECS ELANS config> list elan

ELAN Listing...

-----
Name      Type   Packet Size  Enabled
-----
ELAN1     TokR   4544         Yes
ELAN2     TokR   4544         Yes
-----

LECS ELANS config>
```

## Remove

The **remove** command prompts you to choose an ELAN for removal from the static configuration of the LECS' domain. After you enter your choice, a confirmation is displayed.

**Syntax:** `remove`

**Example:**

```
LECS ELANS config> remove
Choice of ELAN
(1) All
(2) cary01
(3) cary02

Enter Selection [1]?3
Removed ELAN 'cary02'
Selection "ELAN removal" Complete
LECS ELANS config>
```

## Select

The **select** command prompts you to select an ELAN for additional (detailed) configuration.

**Syntax:** `select`

**Example:**

```
LECS ELANS config> select
( 1) cary01
( 2) lgrove01
( 3) lgrove02
( 4) lgrove03
Choice of ELAN [1]?2
ELAN 'lgrove01' selected for detailed configuration

Selected ELAN 'lgrove01'>
```

Additional information on detailed configuration can be found at “Detailed Configuration of an ELAN at the LECS” on page 23-23.

## Configuring ELANs at the LECS

### Exit

Use the **exit** command to return to the LECS config> prompt.

**Syntax:** exit

**Example:** `exit`

## Detailed Configuration of an ELAN at the LECS

This section provides examples of configuring an ELAN in detail. It assumes that you already have completed the configuration requirements outlined in “Configuring ELANs at the LECS” on page 23-20. Detailed configuration is done from the ELAN 'elan-name' selected for detailed configuration> prompt. For example:

```
LE Services config> lecs
Lan Emulation Configuration Server configuration
LECS config> elans
Configuration of ELANs for LECS
LECS ELANs config> select
( 1) cary01
( 2) lgrove01
( 3) lgrove02
( 4) lgrove03
Choice of ELAN [1]?2
ELAN 'lgrove01' selected for detailed configuration
Selected ELAN 'lgrove01'>
```

Use the following commands for detailed configuration:

<i>Table 23-5. LECS ELANs Detailed Configuration Commands Summary</i>	
<b>Command</b>	<b>Function</b>
<b>Les</b>	Manages the LESs that serve the selected ELAN.
<b>List</b>	Lists the configuration of the selected ELAN.
<b>Policy</b>	Manages the policy values assigned to the LESs serving the selected ELAN.
<b>Set</b>	Enables or disables the selected ELAN, and manages the name, type, and maximum frame size of the ELAN.
<b>Tlv</b>	Manages TLVs associated with the selected ELAN.
<b>Exit</b>	Returns to the LECS ELANs config> prompt.

## Les

The **les** command is used to manage the LES ATM addresses which represent LESs serving the selected ELAN. The ATM address of each LES serving this ELAN must exist here. Each LES ATM address may consist of two addresses, a primary LES address and a backup LES address. The backup LES address serves as a hot standby LES which activates when the primary LES goes down. The LECS permits two types of backups to be configured: backup LESs which utilize the IBM LES Redundancy VCC as specified in “LAN Emulation Reliability” on page 18-15, and backup LESs which do not. The difference between these two options is that in the former option, the LECS attempts to use information on local LESs to determine the correct LES for the client. For example, the LECS may query a local backup LES to determine if the LES is currently active or in standby mode. In the latter option, the LECS alternately assigns a client to the primary and backup, regardless of any local information. For more information on the redundancy features of the LES, refer to “LAN Emulation Reliability” on page 18-15 or the IBM 8210 Multiprotocol Switched Services Server Configuration Program User's Guide.

You will be prompted to enter the ATM address of the primary and backup LES. If either of the LESs is located on the same MSS Server, then you may select the local option when prompted. Using this option, you do not need to know the

## Detailed ELAN Configuration

20-byte ATM address of the LES; it will be determined at run-time. If no backup support is provided for a particular LES, the unspecified option should be selected.

For the **les disable**, **les enable**, and **les remove** commands, you are asked to select the LES to which the action applies.

The **les list** command displays the ATM address information for all LESs serving the selected ELAN.

Parameters that can be used with the **les** command are illustrated in the following examples:

**Syntax:** les add  
          disable  
          enable  
          list  
          remove  
          set ...

### Example: les add

```
Selected ELAN 'lgrove01'>les add
( 1) Local
( 2) Remote
Primary LES is [1]? 2
If primary LES is remote, enter ATM address
[]? 39.999999999999.000099990101.222222222222.04
( 1) Unspecified
( 2) Local
( 3) Remote
Backup LES is [1]? 3
If backup LES is remote, enter ATM address
[]? 39.999999999999.000099990102.001bcda02038.07
Do the LESs utilize IBM LES redundancy?? [Yes]: yes
LES ATM address 39.99.99.99.99.99.00.00.99.99.01.01.22.22.22.22.2
added to ELAN 'lgrove01'
```

### Example: les disable

```
ATM address of LES for ELAN

(1) All
(2) Local LES for: lgrove01

Enter Selection: [1]?2
LES disabled: Local LES for: lgrove01
Selection "LES disable" Complete
Selected ELAN 'lgrove01'>
```

### Example: les enable

```
Selected ELAN 'lgrove01'>les enable
ATM address of LES for ELAN

(1) All
(2) Local LES for: lgrove01

Enter Selection: [1]?2
LES enabled: Local LES for: lgrove01
Selection "LES ATM address enable" Complete
Selected ELAN 'lgrove01'>
```



**Example: les list**

```

LESs for ELAN 'lgrove01'

Enbl'd LES ATM address
=====
Yes Local LES for: lgrove01
no backup provided
Selected ELAN 'lgrove01'>

```

**Example: les remove**

```

ATM address of LES for ELAN

(1) All
(2) Local LES for: lgrove01

Enter Selection: [1]?2
Values assigned to LES removed
Delete LES: Local LES for: lgrove01
Selection "LES ATM address removal" Complete
Selected ELAN 'lgrove01'>

```

Use the **les set** command to modify the configuration of a particular LES. The **les set primary** command is used to modify the ATM address of the primary LES, and the **les set backup** command is used to modify the ATM address of the backup LES.

**Example: les set backup**

```

Selected ELAN 'lgrove01'>les set ba
( 1) Local LES for: lgrove01
( 2) 39.99.99.99.99.99.00.00.99.99.01.01.22.22.22.22.22.04
Choice of LES [1]? 2
( 1) Unspecified
( 2) Local
( 3) Remote
Backup LES is [3]? 3
If backup LES is remote, enter ATM address
-39.99.99.99.99.99.00.00.99.99.01.02.00.1B.CD.A0.20.38.0
39.99.99.99.99.99.00.00.99.99.01.02.00.1B.CD.A0.20.38.06
Do the LESs utilize IBM LES redundancy?? [Yes]: no
Backup LES ATM address modified

```

**Example: les set primary**

```

Selected ELAN 'Accounting Ethernet Elan'> les set primary
( 1) Local LES for: Accounting Ethernet Elan

Choice of LES [1]?1
( 1) Local
( 2) Remote

Primary LES is [1]?2
If primary LES is remote, enter ATM address
[Local LES for: Accounting Ethernet Elan]?39.00.00.00.00.00.d0.d0.d0.d0.d0.d0.10.10.10.10.10.03

Primary LES ATM address modified
Selected ELAN 'Accounting Ethernet Elan'>

```

### List

The **list** command provides the following information:

**Syntax:** `list`

**Example:** `list`

```
Selected ELAN 'lgrove01'> list
ELAN Configuration:
  ELAN is      Enabled
  Name:       'lgrove01'
  ELAN Type:   TokenRing
  Max Frame Size: 1516

Selected ELAN 'lgrove01'>
```

### Policy

Use the **policy** command to add, disable, enable, list, or remove policy values that are assigned to the LESs serving the selected ELAN.

**add**

Use the **policy add** command to add a binding between a policy value and a LES to the static configuration of the LECS. Policy values are used to assign clients to LESs. Refer to “Overview of the LECS Function” on page 18-6 for details on how the LECS uses policy values to assign LECs to LESs.

**Syntax:** `policy add pv_type`

Where *pv\_type* is either:

- ESI/SEL of ATM address
- FRAME size
- MAC address
- NAME of ELAN
- PREFIX of ATM Address
- ROUTE descriptor
- TYPE of Elan

**Example:** `policy add prefix`

```
ATM address of LES for policy value(s)

(1) Local LES for: lgrove01

Enter Selection: [1]?1
ATM prefix [ ]?55
ATM address prefix 55
    bound to LES Local LES for: lgrove01
Configure another address?? [Yes]:no
Selected ELAN 'lgrove01'>
```

**disable**

Use the **policy disable** command to disable a policy value in the static configuration of the LECS. This policy value will not become active on the next router restart.

**Syntax:** `policy disable pv_type`

Where *pv\_type* is either:

- ESI/SEL of ATM address
- FRAME size
- MAC address
- NAME of ELAN

- PREFIX of ATM address
- ROUTE descriptor
- TYPE of ELAN

**Example: policy disable prefix**

```

Selected ELAN 'lgrove01'>policy disable
ATM prefix
    (1) All
    (2) 55
LES for: lgrove01

Enter Selection:  [1]? 2
ATM value disabled: 55
Selection "ATM address disable" Complete
Selected ELAN 'lgrove01'>

```

**enable**

Use the **policy enable** command to enable a policy value in the static configuration of the LECS. The policy value must be enabled to become active at the next router restart.

**Syntax: policy enable pv\_type**

Where *pv\_type* is either:

- ESI/SEL of ATM address
- FRAME size
- MAC address
- NAME of ELAN
- PREFIX of ATM address
- ROUTE descriptor
- TYPE of ELAN

**Example: policy enable prefix**

```

Selected ELAN 'lgrove01'>policy enable
ATM prefix
    (1) All
    (2) 25
    (3) 55
to Local LES for: lgrove01
to Local LES for: lgrove01

Enter Selection:  [1]?1
Enabled all ATM prefixes for ELAN 'lgrove01'
Selection "ATM address enable" Complete
Selected ELAN 'lgrove01'>

```

**list**

Use the **policy list** command to display all of the policy values assigned to LESs of the selected ELAN.

**Syntax: policy list pv\_type**

Where *pv\_type* is either:

- all
- ESI/SEL of ATM address
- FRAME size
- MAC address
- NAME of ELAN
- PREFIX of ATM address
- ROUTE descriptor
- TYPE of ELAN

**Example: policy list prefix**

## Detailed ELAN Configuration

```
Selected ELAN 'lgrove01'>policy list
ATM prefixes for ELAN 'lgrove01'
Enabled Value => LES
=====
Selected ELAN 'lgrove01'>
```

### remove

Use the **policy remove** command to remove policy values from the static configuration of the LECS. You will be prompted to select the policy value to remove.

**Syntax:** `policy remove pv_type`

Where *pv\_type* is either:

- ESI/SEL of ATM address
- FRAME size
- MAC address
- NAME of ELAN
- PREFIX of ATM address
- ROUTE descriptor
- TYPE of ELAN

**Example:** `policy remove prefix`

```
ATM prefix
(1) All
(2) 55          to Local LES for: lgrove01
LES for: lgrove01

Enter Selection: [1]? 2
ATM addr prefix deleted: 55
Selection "ATM address removal" Complete
Selected ELAN 'lgrove01'>
```

## Set

Use the **set** command to modify the configuration of the selected ELAN. You may enable or disable the ELAN, or modify its name, type, or maximum frame size. Parameters that can be used with the **set** command are illustrated in the following examples:

**Syntax:** `set enable-disable`  
`frame`  
`name`  
`type`

**Example:** `set enable-disable`

```
Enable ELAN for LEC assignment [yes]yes
ELAN enable-disable modified
Selection "ELAN enable-disable modification" Complete
Selected ELAN 'lgrove01'>
```

**Example:** `set frame`

```
Maximum frame size of ELAN
(1) 1516
(2) 4544
(3) 9234
(4) 18190

Enter Selection: [2]?2
ELAN max frame size modified
Selection "ELAN max frame size modification" Complete
Selected ELAN 'lgrove01'>
```

**Example: set name**

```

Selected ELAN 'lgrove01'> set name
Name of ELAN [lgrove01]lgrove001
ELAN name changed to 'lgrove001'
Selection "ELAN name modification" Complete
Selected ELAN 'lgrove001'>

```

**Example: set type**

```

Type of ELAN
(1) Ethernet
(2) TokenRing

Enter Selection: [2]?2
ELAN type modified
Selection "ELAN type modification" Complete
Selected ELAN 'lgrove001'>

```

## Tlv

TLVs are optional parameters that may be returned to all clients assigned to the selected ELAN. Use the **tlv add** command to add the specified TLVs of the selected ELAN. The following parameters can be used with the **tlv add** command:

tlv add

**Syntax:** `tlv add atm.`

Choose from :

- C7 : Control timeout
- C10:Maximum unknown frame count
- C11:Maximum unknown frame time
- C12:VCC timeout period
- C13:Maximum retry count
- C17:Aging time
- C18:Forward delay time
- C20:Expected LE\_ARP response time
- C21:Flush timeout
- C22:Path switching delay
- C23:Local segment ID
- C24:Mcast send VCC type
- C25:Mcast send VCC avg rate
- C26:Mcast send VCC peak rate
- C28:Connection complete timer

**Syntax:** `tlv add ibm.`

Choose from :

- I4: Validate PCR of DDVCCs
- I5: Maximum Reserved Bandwidth of DDVCCs
- I6: Requested DDVCC Type
- I7: Requested DDVCC Peak Cell Rate
- I8: Requested DDVCC Avg Cell Rate
- I9: Requested DDVCC QoS Class
- I10: Negotiate Cell Rates on DDVCCs

**Syntax:** `tlv add user.`

## Detailed ELAN Configuration

The user can define and add their own TLVs.

### Example: `tlv add atm c21`

```
Selected ELAN 'joe'> tlv add atm c21
C21: Flush Time-out (in seconds) [4]?2
TLV added: C21: Flush timeout (sec)
Selection "Flush timeout TLV add" Complete
Selected ELAN 'joe'>
```

### disable

Use the **tlv disable** command to disable a TLV in the static configuration. The TLV will not become active on the next router restart. You are prompted to select the TLV to disable.

### Syntax: `tlv disable`

TLV choice:

- (1) All
- (2) T x00A03E01 C7 : Control timeout (sec) L 2 V 120
- (3) T x00A03E01 C7 : Control timeout (sec) L 2 V 100
- (4) T x00A03E02 C10: Maxmm unknown frame count L 2 V 1
- (5) T x00A03E03 C11: Mxmm unknwn frm time (sec) L 2 V 1
- (6) T x00A03E04 C12: VCC timeout period (sec) L 4 V 1200
- (7) T x00A03E05 C13: Maximum retry count L 2 V 1
- (8) T x00A03E06 C17: Aging time (sec) L 4 V 300
- (9) T x00A03E07 C18: Forward delay time (sec) L 2 V 15
- (10) T x00A03E08 C20: Expctd LE\_ARP rspnse (sec) L 2 V 1
- (11) T x00A03E09 C21: Flush timeout (sec) L 2 V 4
- (12) T x00A03E0A C22: Path switching delay (sec) L 2 V 6
- (13) T x00A03E0B C23: Local segment ID (hex) L 2 V ff:00
- (14) T x00A03E0C C24: Mcst send VCC type (dec) L 2 V 2
- (15) T x00A03E0C C24: Mcst send VCC type (dec) L 2 V 0
- (16) T x00A03E0D C25: Mcst snd VCC avrg rt (cps) L 4 V 0
- (17) T x00A03E0E C26: Mcst snd VCC peak rt (cps) L 4 V 0
- (18) T x00A03E0F C28: Cnnctn complete time (sec) L 2 V 4

### Example: `tlv disable`

```
Enter Selection: [1]? 1
Disabled all TLVs for ELAN 'lgrove001'
Selection "TLV disable" Complete
Selected ELAN 'lgrove001'>
```

### enable

Use the **tlv enable** command to enable a TLV in the static configuration. The selected TLV will become active on the next router restart. You are prompted to select the TLV to enable.

TLV choice:

```
(1) All
(2) T x00A03E01 C7 : Control timeout (sec)      L 2   V 120
(3) T x00A03E01 C7 : Control timeout (sec)      L 2   V 100
(4) T x00A03E02 C10: Maxmm unknown frame count L 2   V 1
(5) T x00A03E03 C11: Mxmm unknwn frm time (sec) L 2   V 1
(6) T x00A03E04 C12: VCC timeout period (sec)   L 4   V 1200
(7) T x00A03E05 C13: Maximum retry count       L 2   V 1
(8) T x00A03E06 C17: Aging time (sec)           L 4   V 300
(9) T x00A03E07 C18: Forward delay time (sec)   L 2   V 15
(10) T x00A03E08 C20: Expctd LE_ARP rspnse (sec) L 2   V 1
(11) T x00A03E09 C21: Flush timeout (sec)       L 2   V 4
(12) T x00A03E0A C22: Path switching delay (sec) L 2   V 6
(13) T x00A03E0B C23: Local segment ID (hex)    L 2   V ff:00
(14) T x00A03E0C C24: Mcst send VCC type (dec)  L 2   V 2
(15) T x00A03E0C C24: Mcst send VCC type (dec)  L 2   V 0
(16) T x00A03E0D C25: Mcst snd VCC avrg rt (cps) L 4   V 0
(17) T x00A03E0E C26: Mcst snd VCC peak rt (cps) L 4   V 0
(18) T x00A03E0F C28: Cnnctn complete time (sec) L 2   V 4
```

**Example: tlv enable**

```
Enter Selection: [1]?1
Enabled all TLVs for ELAN 'lgrove001'
Selection "TLV enable" Complete
Selected ELAN 'lgrove001'>
```

list

Use the **tlv list** command to list all TLVs of the selected ELAN.

**Example: tlv list**

```
TLVs for ELAN 'lgrove001'

Enabled TLV
=====
Yes Type: x00A03E01 'C7 : Control timeout (sec)'
Len: 2 Value: 120
Yes Type: x00A03E01 'C7 : Control timeout (sec)'
Len: 2 Value: 100
Yes Type: x00A03E02 'C10: Maxmm unknown frame count'
Len: 2 Value: 1
Yes Type: x00A03E03 'C11: Mxmm unknwn frm time (sec)'
Len: 2 Value: 1
Yes Type: x00A03E04 'C12: VCC timeout period (sec)'
Len: 4 Value: 1200
Yes Type: x00A03E05 'C13: Maximum retry count'
Len: 2 Value: 1
Yes Type: x00A03E06 'C17: Aging time (sec)'
Len: 4 Value: 300
Yes Type: x00A03E07 'C18: Forward delay time (sec)'
Len: 2 Value: 15
Yes Type: x00A03E08 'C20: Expctd LE_ARP rspnse (sec)'
Len: 2 Value: 1
Yes Type: x00A03E09 'C21: Flush timeout (sec)'
Len: 2 Value: 4
Yes Type: x00A03E0A 'C22: Path switching delay (sec)'
Len: 2 Value: 6
Yes Type: x00A03E0B 'C23: Local segment ID (hex)'
Len: 2 Value: ff:00
Yes Type: x00A03E0C 'C24: Mcst send VCC type (dec)'
Len: 2 Value: 2
Yes Type: x00A03E0C 'C24: Mcst send VCC type (dec)'
Len: 2 Value: 0
Yes Type: x00A03E0D 'C25: Mcst snd VCC avrg rt (cps)'
Len: 4 Value: 0
Yes Type: x00A03E0E 'C26: Mcst snd VCC peak rt (cps)'
```

## Detailed ELAN Configuration

```
Len: 4 Value: 0
Yes Type: x00A03E0F 'C28: Cnnctn complete time (sec)'
Len: 2 Value: 4
```

```
Selected ELAN 'Igrove001'>
```

### remove

Use the **tlv remove** command to remove a TLV from the static configuration of the selected ELAN. You are prompted to select the TLV to remove.

TLV Choice:

- (1) All
- (2) T x00A03E01 C7 : Control timeout (sec) L 2 V 120
- (3) T x00A03E01 C7 : Control timeout (sec) L 2 V 100
- (4) T x00A03E02 C10: Maxmm unknown frame count L 2 V 1
- (5) T x00A03E03 C11: Mxmm unknwn frm time (sec) L 2 V 1
- (6) T x00A03E04 C12: VCC timeout period (sec) L 4 V 1200
- (7) T x00A03E05 C13: Maximum retry count L 2 V 1
- (8) T x00A03E06 C17: Aging time (sec) L 4 V 300
- (9) T x00A03E07 C18: Forward delay time (sec) L 2 V 15
- (10) T x00A03E08 C20: Expctd LE\_ARP rspnse (sec) L 2 V 1
- (11) T x00A03E09 C21: Flush timeout (sec) L 2 V 4
- (12) T x00A03E0A C22: Path switching delay (sec) L 2 V 6
- (13) T x00A03E0B C23: Local segment ID (hex) L 2 V ff:00
- (14) T x00A03E0C C24: Mcst send VCC type (dec) L 2 V 2
- (15) T x00A03E0C C24: Mcst send VCC type (dec) L 2 V 0
- (16) T x00A03E0D C25: Mcst snd VCC avrg rt (cps) L 4 V 0
- (17) T x00A03E0E C26: Mcst snd VCC peak rt (cps) L 4 V 0
- (18) T x00A03E0F C28: Cnnctn complete time (sec) L 2 V 4

### Example: tlv remove

```
Enter Selection: [1]?2
```

```
TLV deleted: T x00A03E01 C7 : Control timeout (sec) L 2 V 120
Selection "TLV remove" Complete
Selected ELAN 'Igrove001'>
```

## Exit

Use the **exit** command to return to the LECS ELANS config> prompt.

**Syntax:** `exit`

**Example:** `exit`



## Configuring the Policies of a LECS

This section describes the commands to modify the policies that guide the LECS-to-LES assignment procedure. Enter the **policies** command at the LECS `config>` prompt to get to the LECS Policies `config>` prompt where you can enter the following commands:

Command	Function
<b>Add</b>	Add a policy to the static configuration of the LECS.
<b>Disable</b>	Disable a policy of the LECS.
<b>Enable</b>	Enable a policy of the LECS.
<b>List</b>	Lists policies configured for LECS.
<b>Remove</b>	Remove a policy of the LECS.
<b>Exit</b>	Returns to the LECS <code>config&gt;</code> prompt.

### Add

The **add** command adds a policy to the LECS. When adding a policy, you are prompted for the “priority” and “type” of the policy.

Priority specifies the order in which policies are considered; policies with lower priorities are considered earlier. For a more detailed explanation of policies and how the LECS is guided by them, refer to “Overview of the LECS Function” on page 18-6.

Type specifies what information about the client should be used to assign it at the specified priority.

**Syntax:** `add`

**Example:**

```
LECS Policies config> add
Priority of Policy [10]?10
Policy type
(1) byAtmAddr
(2) byMacAddr
(3) byRteDesc
(4) byLanType
(5) byPktSize
(6) byElanNm

Enter Selection: [1]?1
Added policy 'byAtmAddr' at priority 10
Selection "Add assignment policy" Complete
LECS Policies config>
```

## Configuring the Policies of a LECS

### Disable

The **disable** command disables a policy in the static configuration of the LECS. Disabled policies will not become active on the next router restart.

**Syntax:** `disable`

**Example:**

```
LECS Policies> disable
Choice of policy
  (1) All
  (2) 10 byAtmAddr

Enter Selection: [1]?1
Disabled all policies
Selection "Disable assignment policy" Complete
LECS Policies config>
```

### Enable

The **enable** command enables a policy in the static configuration of the LECS. Enable policies become active on the next router restart.

**Syntax:** `enable`

**Example:**

```
LECS Policies config> enable
Choice of policy
  (1) All
  (2) 10 byAtmAddr

Enter Selection: [1]?2
Enabled policy '10 byAtmAddr'
Selection "Enable assignment policy" Complete
LECS Policies config>
```

### List

The **list** command lists the policies currently configured for the LECS.

**Syntax:** `list`

**Example:**

```
LECS Policies config> list
Policy Listing...
Enabled Priority Type
=====
      Yes      10 byAtmAddr
LECS Policies config>
```

## Remove

The **remove** command removes a policy from the static configuration of the LECS.

**Syntax:** `remove`

**Example:**

```
LECS Policies> remove
Choice of policy
  (1) All
  (2) 10 byAtmAddr

Enter Selection: [1]?1
Removed all policies
Selection "Remove assignment policy" Complete
LECS Policies config>
```

## Exit

Use the **exit** command to return to the LECS config> prompt.

**Syntax:** `exit`

**Example:** `exit`

---

### Configuring Security for ELANs

This section describes optional commands related to authentication of LE Client requests to join ELAN(s). The LES-LECS Security Interface is the LE Services component responsible for multiplexing configuration requests from the LESs on the MSS Server to the LECS (which may or may not be on the MSS Server). The LES-LECS interface is a required component if any of the LES-BUSs are using the security features of the MSS Server. See “LAN Emulation Security” on page 18-17 for additional information.

Enter the **security** command at the LE-Services config> prompt to get to the LECS INTERFACE config> prompt.

*Table 23-7. LECS Interface Configuration Commands Summary*

Command	Function
<b>Add</b>	Provides for authentication of client-joins.
<b>Disable</b>	Disables ability to authenticate client-joins.
<b>Enable</b>	Enables ability to authenticate client-joins.
<b>List</b>	Lists parameters for this interface.
<b>Remove</b>	Removes ability to authenticate client-joins.
<b>Set</b>	Sets parameters for this interface (ATM address and traffic type).
<b>Exit</b>	Returns to the LE Services config> prompt.

### Add

Use the **add** command to add a communication path to the LECS authentication of client-joins.

**Syntax:** `add`

**Example:**

```
LECS INTERFACE config> add
( 1) Use burned in ESI
Select ESI [1]?1
Selector 0 is generally reserved for use by the LECS,
Selector 1 is generally reserved for use by the LECS Interface.
LECS Interface Selector [1]?1
LECS INTERFACE config>
```

### Disable

Use the **disable** command to disable LECS authentication of client-joins.

**Syntax:** `disable`

**Example:** `disable`

## Enable

Use the **enable** command to enable LECS authentication of client-joins.

**Syntax:** `enable`

**Example:** `enable`

## List

Use the **list** command to see a detailed list of the parameters associated with this LECS interface.

**Syntax:** `list`

**Example:**

```
LECS INTERFACE config> list
LECS Interface Detailed Configuration
  LECS Interface Enabled/Disabled: Enabled
  ATM Device number: 0
  ESI: Use Burned in ESI
  Selector: 0x01
  Configuration Direct VCC Traffic Type: Best Effort VCC
  Configuration Direct VCC PCR in Kbps: 155000
  Configuration Direct VCC SCR in Kbps: 0
LECS INTERFACE config>
```

## Remove

Use the **remove** command to remove the ability to authenticate client-joins for this ELAN.

**Syntax:** `remove`

**Example:** `remove`

## Set

Use the **set** command to configure the address and the traffic type for this interface.

**Syntax:** `set address`  
`traffic`

**Example:**

```
LECS INTERFACE config> set address
( 1) Use burned in ESI
Select ESI [1]?
Selector 0 is generally reserved for use by the LECS,
Selector 1 is generally reserved for use by the LECS Interface.
LECS Interface Selector [1]?1
LECS INTERFACE config>
```

**Example:**

```
LECS INTERFACE config> set traffic configuration
( 1) Best Effort
( 2) Reserved Bandwidth
Traffic type [1]?1
Peak cell rate in Kbps (1-155000) [155000]? 75000
LECS INTERFACE config>
```

### Exit

Use the **exit** command to return to the LE Services config> prompt.

**Syntax:** exit

**Example:** `exit`

---

## Chapter 24. Monitoring LAN Emulation Services

This chapter describes how to monitor and control operational LE services. Chapter 23, "Configuring LAN Emulation Services" on page 23-1 described the configuration of LE services. The commands detailed in that chapter modified the static memory of the router, and the changes would not take effect until the router is restarted. The commands in this chapter modify the current LE services and take effect immediately. These commands do not modify the static memory of the router and are lost on the next router restart.

There are many components to the LE Services Console environment. There is a component for the LECS, for the LES-LECS Security interface, and for each individual LES-BUS.

From the top-level LE Services Console, one can enter into a console environment for any particular component, or one can create a new LES-BUS component.

This chapter includes the following sections:

- "Accessing the LAN Emulation Services Console Environment" on page 24-2
- "LAN Emulation Services Console Commands" on page 24-3
- "LES-BUS Console Commands" on page 24-6, which includes the Broadcast Manager Console
- "LECS Console Commands" on page 24-30
- "LECS Policies Console Commands" on page 24-40
- "Monitoring ELANs at the LECS" on page 24-44
- "Monitoring ELAN Details at the LECS" on page 24-47
- "Security for LE Service Console Commands" on page 24-54, the LES-LECS interface to validate joins

Individual LE Service components can be stopped, modified, or restarted without restarting the entire router.

---

### Accessing the LAN Emulation Services Console Environment

The LE Services Console environment (available from the GWCON process) is characterized by the 'LE-SERVICES+' prompt. Commands entered at this prompt permit you to work more closely with a particular LE component, or to create a LES-BUS.

To access the LE Services console, do the following:

1. At the OPCON prompt, enter **talk 5**. (For more detail on this command, refer to Chapter 5, "The OPCON Process and Commands.") For example:

```
* talk 5
+
```

After you enter the **talk 5** command, the GWCON prompt (+) displays on the console. If the prompt does not appear when you first enter configuration, press **Return** again.

2. At the CONFIG prompt, enter the **network** command to display the network interface numbers for which the router is currently configured. For example:

```
Config> network

0: :CHARM ATM Adapter
1: :ATM Ethernet LAN Emulation
2: :ATM Token-Ring LAN Emulation
Network number [0]? 0
ATM+
```

**Note:** Two ATM interfaces may be defined.

3. Enter the **network** command

The ATM monitoring prompt (ATM +), is displayed.

4. Enter the **le-services** command

**Example:**

```
ATM+ le-s
LES-Services+
```



## LAN Emulation Services Console Commands

Enter commands at the LES-Services+ prompt.

*Table 24-1. LAN EMULATION Services Monitoring Commands Summary*

Command	Function
<b>? (Help)</b>	Lists the console commands or lists the actions associated with specific commands.
<b>Create</b>	Creates an operating LES-BUS from its configuration data (the configuration data must also exist).
<b>LECS</b>	Takes you to the LECS console environment, described in "LECS Console Commands" on page 24-30.
<b>List</b>	Displays a summary of the operating LES-BUSs.
<b>Security</b>	Takes you to the LES-LECS Security console environment, described in "Security for LE Service Console Commands" on page 24-54.
<b>Work</b>	Takes you to the console environment for a particular LES-BUS, as described in "LES-BUS Console Commands" on page 24-6.
<b>Exit</b>	Returns to the previous prompt.

## Help

Use the **? (help)** command to list the commands that are available from the current prompt level. You also can enter a ? after a specific command name to list its options.

**Syntax:** ?

**Example:** LES Services+ ?

```
create
lecs
list
security
work
exit
```

## Create

Use the **create** command to create an operating LES-BUS from its configuration. Before creating a LES-BUS, its configuration must first exist. See "Configuring a LES-BUS" on page 23-4 for an explanation of how to configure a LES-BUS.

**Syntax:** `create elan-name`

elan-name

Name of the ELAN.

**Example create**

```
LE-SERVICES+ create
ELAN Name (ELANxx) []? IBM Token Ring Test ELAN!
LES/BUS: 'IBM Token Ring Test ELAN!': STARTING
```

## LECS

Use the **lecs** command to enter the LECS Console environment.

**Syntax:** lecs

### Example lecs

```
LE-SERVICES+ lecs
LECS console+
```

## List

Use the **list** command to display a summary of the currently operating LES-BUSs.

**Syntax:** list

### Example list

```
LE-SERVICES+ list
ELAN Type (E=Ethernet/802.3, T=Token Ring/802.5)
| Interface #
| | LES-BUS State (UP=Up, ID=Idle, ND=Net Down, ER=Error/Down,
| | | **=Other; Work with specific LES-BUS to see actual state)
| | |
| | | ELAN Name                               LES ATM Addr
-----
E 0 UP IBM Ethernet H52 Test ELAN!          39840F00000000000000000000000000110005A68000A01
T 0 UP IBM Token Ring Test ELAN!           39840F00000000000000000000000000110005A68000A02
LE-SERVICES+
```

## Security

Use the **security** command to enter the console environment for the LES-LECS Security Interface component. This is the component which multiplexes security requests between the LE Servers on this router and the LECS (which may or may not be on this router).

**Syntax:** security

### Example security

```
LE-SERVICES+ security
LES-LECS interface+
```

## Work

Use the **work** command to enter the console environment for a particular operating LES-BUS. One can use the **list** command to display all of the operating LES-BUSs.

**Syntax:** work elan-name

elan-name  
Name of the ELAN.

### Example work

```
LE-SERVICES+work
ELAN Name (ELANxx) []? IBM Token Ring Test ELAN!
EXISTING LES-BUS+
```

## Exit

Returns to the ATM+ prompt.

**Syntax** `exit`

## LES-BUS Console Commands

Enter commands at the EXISTING LES-BUS+ prompt.

<i>Table 24-2. LES-BUS Monitoring Commands Summary</i>	
<b>Command</b>	<b>Function</b>
<b>? (Help)</b>	Lists the console commands or lists the actions associated with specific commands.
<b>Database</b>	Flushes all cache entries for a specified Broadcast Manager Protocol, or lists database entries.
<b>Delete</b>	Deletes a LES-BUS.
<b>Disable</b>	Disables an existing LES-BUS component: Broadcast Manager (IP,IPX, or NETBIOS), BUS Monitor, Redundancy, or Source Route Manager. Disabling of the chosen option occurs immediately, but the LES-BUS's configured state in Static RAM does not change.
<b>Enable</b>	Enables an existing LES-BUS component: Broadcast Manager (IP,IPX, or NETBIOS), BUS Monitor, Redundancy, or Source Route Manager. Enabling of the chosen option occurs immediately, but the LES-BUS's configured state in Static RAM does not change.
<b>List</b>	Lists the status and current configuration parameters of the LES-BUS.
<b>Restart</b>	Restarts a running or stopped LES-BUS. A LES-BUS can be restarted using the parameters configured under the Talk 5 or Talk 6 interface.
<b>Set</b>	Sets LES-BUS configuration parameters. The parameter set by the user is immediately used by the LES-BUS, but the LES-BUS's configured parameter values in Static RAM do not change.
<b>Statistics</b>	Clears or displays LES-BUS statistics.
<b>Stop</b>	Stops the operation of LES-BUS.
<b>Exit</b>	Returns to the LE-SERVICES+ prompt.

## Help

Use the **? (help)** command to list the commands that are available from the current prompt level. You also can enter **?** after a specific command name to list its options.

**Syntax:** ?

**Example:** ?

```
databases
delete
disable
enable
list
restart
set
statistics
exit
```

## Database

The **database** command has two uses. It can be used to **flush** all cache entries for a Broadcast Manager Protocol, or to **list** information about database entries. See “Database Flush” and “Database List” for more information.

### Database Flush

Use this command to flush all cache entries for a Broadcast Manager Protocol.

**Syntax:** `database flush protocol`

Where *protocol* is one of the following:

- IP
- IPX
- NetBios
- Source Route Management

**Example:** `database flush ip`

### Database List

Use this command to list general information about all entries in a given database, or to list detailed information about a user specified entry in a database.

**Syntax:** `database list all . . .`  
`specific . . .`

all *database*

Lists general information about all entries in the specified database. Valid databases are:

- BCM-Learned-MAC
- IP
- IPX
- LEC
- NetBios
- Registered-MAC
- Route-Descriptors
- Source Route Management

**Example:** `database list all IP`

IP Address	MAC Address	TTL	Usage Count
-----	-----	---	-----
9.67.195.151	100.00.5A.11.98.76	5	1

Where:

*IP address*

Is the IP address

*MAC address*

Is the MAC address associated with the IP address

*TTL (Time to Live)*

Is the amount of time (in minutes) remaining before this entry is removed from the cache.

*Usage count*

Is the number of times entry was refreshed.

**Example: database list all lec**

```
LEC-LES and LEC-BUS State (UP=Up, ID=Idle, --. --.
**=Other; Show specific LEC to see actual) v v
LEC Primary ATM Address Proxy LEC ID State LES BUS #ATM #Reg #Lrnd
Adrs MACs MACs
-----
39840f00000000000000000000000000110005abad00400 N 0001 UP UP 1 1 0
39840f00000000000000000000000000110005abad00401 N 0002 UP UP 1 1 0
```

Where:

*LEC primary ATM address*

Is the primary ATM address of the LEC

*Proxy*

Indicates whether or not this LE Client is a proxy LEC. A proxy LEC responds to LE ARP Requests for MAC addresses which it serves. These MAC addresses are not registered with the LES.

*LEC ID*

Is the LE Client Identifier

*State LES*

Is the operational state of the LEC at the LES. Possible states are:

- UP
- ID
- \*\* Other (to see this state use the **database list specific LEC** command.)

*State BUS*

Is the operational state of the LEC at the BUS. Possible states are:

- UP = Up
- ID = Idle
- \*\* = Other (to see this state, use the **database list specific LEC** command.)

*Number of ATM addresses*

Is the number of ATM addresses associated with the LEC.

*Number of registered MACs*

Is the number of registered MAC addresses associated with the LEC.

*Number of learned MACs*

Is the number of BCM learned MAC addresses associated with the LEC.

*specific database*

Lists detailed information about a user specified entry. Valid databases are:

- IP
- IPX
- LEC
- MAC
- NetBios
- Route-Descriptors

**Example: database list specific ip**

```
IP address [186.186.186.186]? 7.7.7.7
IP Address: 7.7.7.7
MAC Address: 10.00.5A.BA.D0.88
MAC Address Type: Registered
LEC ATM Address: 399999999999000009999010210005159176202
LEC ID: 0x0001
```

```

LEC State at LES:      OPERATIONAL
LEC State at BUS:     OPERATIONAL
If dormant, proto ages in: 4 minute(s)
Usage Count:          1
SRM Ring Number:      unknown

```

Where:

*IP address*

Is a user entered IP address.

*MAC address*

Is the MAC address associated with the IP address.

*MAC address type*

Is the database entry type. Possible values are:

Registered

an entry registered by the LEC

Static Volatile

an entry created by the network manager

BCM Learned

an entry learned by the Broadcast Manager

Unknown

an entry of an unknown type

*LEC ATM address*

Is the primary ATM address of the LEC which has the given MAC address.

*LEC ID*

Is the LE Client Identifier

*LEC state at LES*

Is the operational state of the LEC at the LES.

Possible states are:

IDLE

the LES-BUS is not active.

JOINING

A Control Direct VCC was accepted.

JOIN REJECTED

A Join request was rejected.

JOIN VERIFICATION

A request was sent to the LECS to validate the LEC's join request.

SIGNAL WAIT

The LES is waiting for completion of in-progress call to establish a first leaf of Control Distribute VCC.

SIGNALLING

The LES is initiating signalling to establish a Control Distribute VCC to the LEC.

OPERATIONAL

The Join was successful.

UNKNOWN

Indicates an unknown state.

## LES-BUS Console commands

### *LEC state at BUS*

Is the operational state of the LEC at the BUS.

Possible states are:

#### IDLE

the LES-BUS is not active.

#### JOINING

A Control Direct VCC was accepted.

#### JOIN REJECTED

A Join request was rejected.

#### JOIN VERIFICATION

A request was sent to the LECS to validate the LEC's join request.

#### SIGNAL WAIT

The LES is waiting for completion of in-progress call to establish a first leaf of Control Distribute VCC.

#### SIGNALLING

The LES is initiating signalling to establish a Control Distribute VCC to the LEC.

#### OPERATIONAL

The Join was successful.

#### UNKNOWN

Indicates an unknown state.

### *If dormant, proto ages in*

Is the amount of time (in minutes) remaining before this entry is removed from the cache.

### *Usage count*

Is the number of times entry was refreshed

### *SRM ring number*

For SRM, 802.5 ring number where IP address is located

### **Example: database list specific LEC**

```
LECID [0]? 1
LEC ID: 0x0001
  LEC ATM Address: 399999999999900009999010210005159176202
  Proxy: No
  LEC State at LES: OPERATIONAL
  Entered LES State at: 00.00.03.63 (System Up Time)
  LEC State at BUS: OPERATIONAL
  Entered BUS State at: 00.00.03.87 (System Up Time)
  Control Direct Vcc: OPERATIONAL 0/42
  Control Distribute Vcc: OPERATIONAL 0/57
  Multicast Send Vcc: OPERATIONAL 0/61
  Multicast Forward Vcc: OPERATIONAL 0/78
  MAC Address in Join Req: 10.00.5A.BA.D0.88
  Packet Tracing Eligible: No
  # ATM Address Mappings: 1
  # MAC Address Mappings: 1
  # RD Mappings: 0
  # BCM Learned MAC Adrs: 0
  # BCM Protocol Mappings: 1
  # SRM Ring Mappings: 0
```

Where:



*LEC ID*

Is the LE Client Identifier

*LEC ATM address*

Is the ATM address of the LEC

*Proxy*

Indicates whether this LEC is a proxy LEC. Proxy LECs respond to LE ARP Requests for MAC addresses they serve. These MAC

*LEC state at LES*

Indicates the operational state of the LEC at the LES. Possible states are:

IDLE

the LES-BUS is not active.

JOINING

A Control Direct VCC was accepted.

JOIN REJECTED

A Join request was rejected.

JOIN VERIFICATION

A request was sent to the LECS to validate the LEC's join request.

SIGNAL WAIT

The LES is waiting for completion of in-progress call to establish a first leaf of Control Distribute VCC.

SIGNALLING

The LES is initiating signalling to establish a Control Distribute VCC to the LEC.

OPERATIONAL

The Join was successful.

UNKNOWN

Indicates an unknown state.

*Entered LES state at*

Is the System Up Time that LEC transitioned into its current state at the LES. Time is in hours.minutes.seconds.hundredths format.

*LEC state at BUS*

Is the operational state of the LEC at the BUS. Possible states are:

IDLE

A Control Direct VCC was accepted, or a Multicast VCC to LEC was released.

SIGNAL WAIT

The BUS is waiting for completion of in-progress call to establish the first leaf of Multicast Forward VCC.

SIGNALLING

The BUS initiated signalling to establish Multicast Forward VCC to LEC.

OPERATIONAL

A Multicast Forward VCC to the LEC was successfully established.

UNKNOWN

Indicates an unknown state.

## LES-BUS Console commands

### *Entered BUS state at*

Is the time that the LEC transitioned into its current state at the BUS. Time is in hours.minutes.seconds.hundredths format.

### *MAC address in Join Req*

The MAC address in the Join Request, if present.

### *Packet tracing eligible*

Indicates whether packets are eligible for tracing, provided ELS trace events are enabled.

### *# ATM address mappings*

Is the number of ATM addresses associated with this LEC.

### *# MAC address mappings*

Is the number of MAC addresses associated with this LEC.

### *# RD mappings*

Is The number of route descriptors associated with this LEC.

### *# BCM learned MAC addrs*

Is the number of Broadcast Manager learned MAC addresses associated with this LEC.

### *# BCM protocol mappings*

Is the number of protocols mapped to this LEC.

### *# SRM ring mappings*

Is the number of Source Route Management ring numbers associated with this LEC.

### **Example: database list specific MAC**

```
Registered or BCM Learned MAC Address: []? 10.00.5A.BA.D0.88
Registered MAC Address:      10.00.5A.BA.D0.88
LEC ATM Address:             399999999999900009999010210005159176202
Registering ATM Address:     399999999999900009999010210005159176202
LEC ID:                       0x0001
Entry Type:                   Registered
LEC State at LES:             OPERATIONAL
LEC State at BUS:            OPERATIONAL
SRM Ring Number:             unknown
# BCM Protocol Mappings: 1
IPX Network / Node Number:   00.00.77.77 / 10.00.5A.BA.D0.88
```

Where:

### *BCM learned MAC address*

Is the Broadcast Manger learned MAC address. This field is displayed for learned MAC addresses only.

### *Registered MAC address*

Is the registered MAC Address. This field is displayed for registered MAC addresses only.

### *Registering ATM address*

Is an ATM address of the LEC which registered the MAC address. This field is displayed for registered MAC addresses only.

### *Entry type*

Is the Database entry type. Possible values are:

Registered

Registered entry (Entry was registered by a LEC)

Static Volatile

Static volatile entry (Entry was created by the network manager)

*LEC ATM address*

Is the ATM address of the LEC which has the given MAC address.

*LEC ID*

Is the LE Client Identifier.

*LEC state at LES*

Is the operational state of the LEC at the LES.

Possible states are:

IDLE

the LES-BUS is not active.

JOINING

A Control Direct VCC was accepted.

JOIN REJECTED

A Join request was rejected.

JOIN VERIFICATION

A request was sent to the LECS to validate the LEC's join request.

SIGNAL WAIT

The LES is waiting for completion of in-progress call to establish a first leaf of Control Distribute VCC.

SIGNALLING

The LES is initiating signalling to establish a Control Distribute VCC to the LEC.

OPERATIONAL

The Join was successful.

UNKNOWN

Indicates an unknown state.

*LEC state at BUS*

Is the operational state of the LEC at the BUS.

Possible states are:

IDLE

the LES-BUS is not active.

JOINING

A Control Direct VCC was accepted.

JOIN REJECTED

A Join request was rejected.

JOIN VERIFICATION

A request was sent to the LECS to validate the LEC's join request.

SIGNAL WAIT

The LES is waiting for completion of in-progress call to establish a first leaf of Control Distribute VCC.

SIGNALLING

The LES is initiating signalling to establish a Control Distribute VCC to the LEC.

## LES-BUS Console commands

### OPERATIONAL

The Join was successful.

### UNKNOWN

Indicates an unknown state.

### *SRM ring number*

For SRM, the 802.5 ring where the BCM Learned MAC address is located.

### *# BCM protocol mappings*

Is the number of protocols mapped to this MAC address. A list of the protocol mappings will be displayed. The possible mappings are:

- IPX Network / Node Number
- IP address
- NetBIOS name string
- NetBIOS name in hex (shown only if NetBIOS name string has unprintable characters)

## Delete

Use the **delete** command to stop the LES-BUS and remove it from the active configuration. (The LES-BUS definition remains in static RAM). If the **delete** command is issued and you then want to start the LES-BUS, without restarting the MSS Server, you must issue the **create** command.

```
EXISTING LES-BUS+delete
LES-BUS: 'test':
DELETED
```

## Disable

Use the **disable** command to disable LES-BUS components.

**Syntax:** disable

You may dynamically disable Broadcast Manager (IP,IPX, or NETBIOS), BUS Monitor, Redundancy, or Source Route Manager. Disabling of the chosen option occurs immediately, but the LES-BUS's configured state in Static RAM does not change. If you wish to change permanently the configured state in Static RAM, use the `config>` interface.

**Example: disable**

```
EXISTING LES-BUS+ disable ?
BROADCAST manager
BUS-MONITOR
REDUNDANCY
SOURCE route management

EXISTING LES-BUS+ disable broadcast ?
IP
IPX
NETBIOS

EXISTING LES-BUS+ disable broadcast ip
LES-BUS: 'test' : parameter successfully set

EXISTING LES-BUS+ disable broadcast ipx
LES-BUS: 'test' : parameter successfully set

EXISTING LES-BUS+ disable broadcast netbios
LES-BUS: 'test' : parameter successfully set

EXISTING LES-BUS+ disable bus-monitor
```

```
LES-BUS: 'test' : parameter successfully set

EXISTING LES-BUS+ disable redundancy
LES-BUS: 'test' : parameter successfully set

EXISTING LES-BUS+ disable source
LES-BUS: 'test' : parameter successfully set
```

## Enable

Use the **enable** command to enable LES-BUS components.

**Syntax:** `enable`

You may dynamically enable Broadcast Manager (IP,IPX, or NETBIOS), BUS Monitor, Redundancy, or Source Route Manager. Enabling of the chosen option occurs immediately, but the LES-BUS's configured state in Static RAM does not change. If you wish to change permanently the configured state in Static RAM, you should use the `config>` interface.

### Notes:

1. You cannot enable the Broadcast Manager while the BUS is in *Adapter* or *VCC-Splice* mode.
2. You cannot enable the BUS-Monitor while the BUS is in *VCC-Splice* mode.

### Example: `enable`

```
EXISTING LES-BUS+ enable ?
BROADCAST manager
BUS-MONITOR
REDUNDANCY
SOURCE route management

EXISTING LES-BUS+ enable broadcast ?
IP
IPX
NETBIOS

EXISTING LES-BUS+ enable broadcast ip
LES-BUS: 'test' : parameter successfully set

EXISTING LES-BUS+ enable broadcast ipx
LES-BUS: 'test' : parameter successfully set

EXISTING LES-BUS+ enable broadcast netbios
LES-BUS: 'test' : parameter successfully set

EXISTING LES-BUS+ enable bus-monitor
LES-BUS: 'test' : parameter successfully set

EXISTING LES-BUS+ enable redundancy
( 1) Primary LES-BUS
( 2) Backup LES-BUS
Redundancy Role [0]? 2
LES-BUS: 'test' : parameter successfully set

EXISTING LES-BUS+ enable source
LES-BUS: 'test' : parameter successfully set
```

## List

Use the **list** command to list the LES-BUS's status and currently running configuration parameters.

**Syntax:** `list`

**Example:** `list`

```
ELAN Name:                IBM ethernet H52 Test ELAN!
ELAN Type:                Ethernet
ATM Device number:       0
# of Proxy LEC's:        0
# of Non-Proxy LEC's:    0
LES ATM Address:         399999999999999999990000999999010110005A68001202

-Status-
LES-BUS State:            OPERATIONAL
Major Reason LES-BUS was last Down: unknown err code
Minor Reason LES-BUS was last Down: unknown err code
LES-BUS State last changed at: 00.00.03.10 (System Up Time)
LES-LEC Status Table changed at: 00.10.30.56 (System Up Time)
BUS-LEC Status Table changed at: 00.10.30.56 (System Up Time)
UNI Version:              3.0
IP BCM:                  ACTIVE
IPX BCM:                 ACTIVE
NetBIOS BCM:             ACTIVE
IPX BCM Active Forwarding List Size: 0

-Current Configuration-
LES-BUS Enabled/Disabled: Enabled
ATM Device number:       0
End System Identifier (ESI): 10.00.5A.68.00.12
Selector Byte:           0x02
ELAN Type:               (S2) Ethernet
Max Frame Size:          (S3) 1516
Control Timeout:         (S4) 120
Max Frame Age:           (S5) 1
LECID Range Minimum     1
LECID Range Maximum     65279
Validate Best Effort Peak Cell Rate (PCR): No
Control Distribute VCC Traffic Type: Best Effort VCC
Control Distribute VCC PCR in Kbps: 155000
Control Direct VCC Max Reserved Bandwidth: 0
Multicast Forward VCC Traffic Type: Best Effort VCC
Multicast Forward VCC PCR in Kbps: 155000
Multicast Send VCC MAX Reserved Bandwidth: 0

-LES-BUS Options-
BUS Mode:                System
Security (LECS Validation of Joins): Disabled
Partition LE_ARP_REQUEST Forwarding Domain: Yes
LE_ARP RESPONSE Destination: One client
Partition Unicast Frame Domain: Yes
Redundancy:              Disabled
ATM address trace filter value: 000000000000000000000000000000000000000000000000
ATM address trace filter mask: FFFFFFFFFFFFFFFFFFFFFFFFFFFFFFFFFFFFFFFFFFFFFFFFFF

-BUS Monitor Configuration-
Monitor Host Usage of BUS: Disabled
# Top Hosts to Record:  10
# Seconds in each sample interval: 10
# Minutes between sample intervals: 30
Frame sampling rate:    1 out of 10

-Broadcast Manager Configuration-
IP BCM:                  Enabled
IPX BCM:                 Enabled
NetBIOS BCM:            Enabled
BCM IP Cache Aging Time: 5
BCM IPX Cache Aging Time: 3
```

```

BCM NetBIOS Cache Aging Time:          15
BCM IPX Maximum Forwarding List:       50
No BCM IPX Static Entries defined

```

Where:

*LES-BUS State*

is the operational state of the LES-BUS. Possible states are:

IDLE

LES-BUS not active.

INITIALIZATION

LES-BUS control block is being initialized.

ATM ADDR ACTIVATION

LES-BUS ATM addresses are being activated.

GET UNI VERSION

Getting UNI version that is being run.

GOT UNI VERSION

UNI version has been determined.

OPERATIONAL

LES-BUS state is up or operational.

ATM ADDR DEACTIVATED

ATM address deactivated by switch.

NET DOWN

ATM interface not operational.

ERROR /DOWN

The operation of LES-BUS instance terminated due to fatal error.

UNKNOWN

Unknown state.

*Major Reason LES-BUS was last Down*

is the reason why the LES-BUS went down.

*Minor Reason LES-BUS was last Down*

contains additional information about why the LES-BUS went down.

*LES-BUS State last changed at*

is the system up time that the LES-BUS entered its current state. The format is hours.minutes.seconds.hundredths

*LES-LEC Status Table changed at*

is the most recent system up time that a LEC's state changed at the LES.

*BUS-LEC Status Table changed at*

is the most recent system up time that a LEC entered or exited operational state at the BUS.

See "LES-BUS Console Commands" on page 24-6 for more information about the configuration parameters.

### Restart

Use the **restart** command to restart a running or stopped LES-BUS. A LES-BUS can be restarted using the parameters configured under the Talk 5 or Talk 6 interface.

**Syntax:** **restart**

**Example 1:**

```
restart t5 (Using configuration parameters in Talk 5)
```

**Example 2:**

```
restart t6 (Using configuration parameters in Talk 6)
```

### Set

Use the **set** command to set the values of various LES-BUS configuration parameters.

**Syntax:** **set**

The user may dynamically set the following LES-BUS configuration parameters. The parameter set by the user is immediately used by the LES-BUS, however the LES-BUS's configured parameter values in Static RAM do not change. If the user wishes to permanently change the configured state in Static RAM, the config> interface should be used.

**Example: set**

```
EXISTING LES-BUS+ set ?
BUS-MONITOR settings
CONTROL timeout
FRAME-AGE
IP broadcast cache age
IPX broadcast cache age
LE ARP response destination
NETBIOS broadcast cache age
SECURITY (LECS validation of Joins)
TRACE
TRAFFIC type

EXISTING LES-BUS+ set bus-monitor ?
DURATION-OF-SAMPLE (# Seconds in each sample interval)
SAMPLE-RATE (Frame sampling rate)
TIME-BETWEEN-SAMPLES (# Minutes between sample intervals)
TOP-NUMBER-MACS (# Top Hosts to Record)

EXISTING LES-BUS+ set bus-monitor duration
Duration of sample interval in seconds (1-600) [10]?
LES-BUS: 'test' : parameter successfully set

EXISTING LES-BUS+ set bus-monitor sample
Frame sampling rate (1-1000) [10]?
LES-BUS: 'test' : parameter successfully set

EXISTING LES-BUS+ set bus-monitor time
Number of minutes between sample intervals (1-120) [30]?
LES-BUS: 'test' : parameter successfully set

EXISTING LES-BUS+ set bus-monitor top
Number of top MAC addresses to record (1-100) [10]?
LES-BUS: 'test' : parameter successfully set
```



```

EXISTING LES-BUS+ set control
Control timeout (10-300) [110]? 120
LES-BUS: 'test' : parameter successfully set

EXISTING LES-BUS+ set frame-age
Maximum frame age (1-4) [1]?
LES-BUS: 'test' : parameter successfully set

EXISTING LES-BUS+ set ip
IP cache age, in minutes (2-20) [5]?
LES-BUS: 'test' : parameter successfully set

EXISTING LES-BUS+ set ipx
IPX cache age, in minutes (1-10) [3]?
LES-BUS: 'test' : parameter successfully set

EXISTING LES-BUS+ set netbios
NetBIOS cache age, in minutes (10-20) [15]?
LES-BUS: 'test' : parameter successfully set

EXISTING LES-BUS+ set le
  ( 1) One client
  ( 2) All clients
LE ARP response destination [1]?
LES-BUS: 'test' : parameter successfully set

EXISTING LES-BUS+ set security
Enable Security (LECS validation of Joins)? [No]:
LES-BUS: 'test' : parameter successfully set

EXISTING LES-BUS+ set trace ?
MASK
VALUE

EXISTING LES-BUS+ set trace mask
ATM address trace filter mask [FF.FF.FF.FF.FF.FF.FF.FF.FF.FF.FF.FF.FF.FF.FF.FF]?
LES-BUS: 'test' : parameter successfully set

EXISTING LES-BUS+ set trace value
ATM address trace filter value [00.00.00.00.00.00.00.00.00.00.00.00.00.00.00.00.00]?
LES-BUS: 'test' : parameter successfully set

EXISTING LES-BUS+ set traffic ?
MAXIMUM reserved bandwidth
VALIDATE peak cell rate

EXISTING LES-BUS+ set traffic maximum ?
CONTROL Direct VCC maximum
MULTICAST Send VCC maximum

EXISTING LES-BUS+ set traffic maximum control
Maximum reserved bandwidth in Kbps (0 - 155000) [0]?
LES-BUS: 'test' : parameter successfully set

EXISTING LES-BUS+ set traffic maximum multicast
Maximum reserved bandwidth in Kbps (0 - 155000) [0]?
LES-BUS: 'test' : parameter successfully set

EXISTING LES-BUS+ set traffic validate
Validate peak cell rate of best effort VCCs? [No]:
LES-BUS: 'test' : parameter successfully set

```

## Statistics

Use the **statistics** command to either clear or display statistics associated with LAN Emulation MIBs. Some of the fields displayed by the **statistics** command correspond to specific MIB entries that are located at IBMLESERV.MIB.

**Syntax** statistics clear ...  
display ...

The **statistics clear** command eliminates statistical data that previously was gathered for BCM, LES-BUS, or Source Route Management.

**Syntax:** clear bcm *protocol*  
les-bus *type*  
source *protocol*

Where *protocol* or *type* can be:

	<b>protocol or type</b>
clear bcm	all ip ipx netbios
clear les	bus lec-bus <i>atm-address</i> lec-bus <i>lecid</i> lec-les <i>atm-address</i> lec-les <i>lecid</i> les
clear source	all ip ipx netbios

### Example

```
Existing LES-BUS+ statistics clear bcm all
Existing LES-BUS+
```

The **statistics display** command provides statistical data for BCM, LES-BUS, and Source Route Management.

**Syntax:** statistics display bcm **protocol-stats**  
bus monitor  
les-bus *protocol-stats*  
source *protocol-stats*

Where “protocol-stats” can be:

	<b><u>protocol-stats</u></b>
statistics display bcm	all ip ipx netbios

```

statistics display les-bus bus
                        lec-bus atm-address
                        lec-bus lecid
                        lec-les atm-address
                        lec-les lecid
                        les

```

```

statistics display source all
                        ip
                        ipx
                        netbios

```

**Example:**

EXISTING LES-BUS+ **sta display bcm all**

	IP	IPX	NetBIOS	Examined by BCM
	-----	-----	-----	-----
inFrms:	182972	324	374	299518
inOctets:	11410392	36798	32840	22342391
inReturns:	129888	6	334	246076
inReturnOctets:	8113160	564	30254	19006339
inFiltered:	0	0	40	40
inFilteredOctets:	0	0	2586	2586
outFrms:	53084	318	0	53402
outFrmsOctets:	3297232	36234	0	3333466
outError:	0	0	0	0
outErrorOctets:	0	0	0	0

The statistical counters for the **sta display bcm all** command map to MIB variables as follows:

"BCM-Examined"

Displayed Name

-----

```

inFrms
inOctets
inReturns
inReturnOctets
inFiltered
inFilteredOctets
outFrms
outFrmsOctets
outError
outErrorOctets

```

MIB ENTRY

-----

```

bcmFramesReceived
bcmOctetsReceived
bcmFramesReturned
bcmOctetsReturned
bcmFramesDiscarded
bcmOctetsDiscarded
bcmFramesTransmitted
bcmOctetsTransmitted
bcmTransmitErrorFrames
bcmTransmitErrorOctets

```

IP DISPLAYED NAME

-----

```

inFrms
inOctets
inReturns
inReturnOctets
inFiltered
inFilteredOctets
outFrms
outFrmsOctets
outError
outErrorOctets

```

MIB ENTRY

-----

```

bcmIpFramesReceived
bcmIpOctetsReceived
bcmIpFramesReturned
bcmIpOctetsReturned
bcmIpFramesDiscarded
bcmIpOctetsDiscarded
bcmIpFramesTransmitted
bcmIpOctetsTransmitted
bcmIpTransmitErrorFrames
bcmIpTransmitErrorOctets

```

IPX DISPLAYED NAME

MIB ENTRY

## LES-BUS Console commands

```

-----
inFrms
inOctets
inReturns
inReturnOctets
inFiltered
inFilteredOctets
outFrms
outFrmsOctets
outError
outErrorOctets
-----
bcmIpxFramesReceived
bcmIpxOctetsReceived
bcmIpxFramesReturned
bcmIpxOctetsReturned
bcmIpxFramesDiscarded
bcmIpxOctetsDiscarded
bcmIpxFramesTransmitted
bcmIpxOctetsTransmitted
bcmIpxTransmitErrorFrames
bcmIpxTransmitErrorOctets

```

```

NetBIOS DISPLAYED NAME
-----
inFrms
inOctets
inReturns
inReturnOctets
inFiltered
inFilteredOctets
outFrms
outFrmsOctets
outError
outErrorOctets
-----
MIB ENTRY
-----
bcmNbFramesReceived
bcmNbOctetsReceived
bcmNbFramesReturned
bcmNbOctetsReturned
bcmNbFramesDiscarded
bcmNbOctetsDiscarded
bcmNbFramesTransmitted
bcmNbOctetsTransmitted
bcmNbTransmitErrorFrames
bcmNbTransmitErrorOctets

```

display bus

Displays statistical data associated with BUS Monitoring.

### Example:

```

EXISTING LES-BUS+ sta display bus
-BUS Monitor Status-
Currently in a sample interval ?      no
Next sample interval scheduled in:    0 minute(s), 18 second(s)

-Results of Last Complete Sample-
BUS Monitor sample interval started at: 13.27.03.98 (System Up Time)
Duration of sample interval:          59 second(s)
# Top Hosts Actually Recorded:        5
# Frames Received in sample interval:  301
# Frames Sampled in sample interval:   301
Frame sampling rate:                  1 out of 1

Rank  Source MAC Addr.  Associated LEC ATM Address  # frames
-----
1  10.00.5A.AA.AA.AA  39999999999900009999010110005A12340002  100
2  10.00.5A.66.66.66  39999999999900009999010110005A12340002   60
3  10.00.5A.EE.EE.EE  39999999999900009999010110005A12340002   52
4  10.00.5A.55.55.55  39999999999900009999010110005A12340001   50
5  10.00.5A.99.99.99  39999999999900009999010110005A12340001   39
EXISTING LES-BUS+

```

statistics display les lec-bus lecid

Lists the number of multicast, broadcast, and unknown forward requests received or discarded by the BUS from this LEC.

```

EXISTING LES-BUS+ sta display les lec-bus lecid
LECID [0]? 1
ATM Forum LEC-BUS MIB Statistics:
recvs:      1
discards:   0

```

The statistical counters for some fields generated by the **sta display les lec-bus** command map to MIB variables as follows:

LEC-BUS Displayed Name	MIB ENTRY
recvs	busLecRecv
discards	busLecDiscards

statistics display les bus *or* lec-bus *or* lec-les *or* les  
 Displays statistical data for a given LEC or ELAN.

**Example:**

```
EXISTING LES-BUS+ sta display les-bus bus
ATM Forum BUS MIB Statistics:
  inDiscards:                0
  inOctets:                  67200
  inUcastFrms:               0
  inMcastFrms:              1050
  frmTimeouts:               0
  mcastSendRefused:         0
  mcastFwdFailure:          0
Other Statistics:
  inExplorer:                0
  inFlushReq:                0
  outFlushReq_mcastFwd:     0
  outFlushReq_mcastSend:    0
  outUcastFrms_mcastFwd:    0
  outUcastFrms_mcastSend:   0
  outMcastFrms:              1050
  outOctets:                  67200
  mcastSendReleased:        0
  mcastFwdReleased:         0
  mcastFwdPartyReleased:    0
  invalidProtocol_droppedFrames: 0
  verNotSup_droppedFrames:  0
  invalidOpcode_droppedFrames: 0
  invalidLecid_droppedFrames: 0
  invalidSize_droppedFrames: 0
  flushToBus_droppedFrames:  0
  incompleteSourceConnect_droppedFrames: 0
  incompleteTargetConnect_droppedFrames: 0
  noProxy_droppedFrames:    0
```

**ATM Forum BUS MIB Statistics:**

The statistical counters for some fields generated by the **sta display les-bus bus** command map to MIB variables as follows:

BUS DISPLAYED NAME	MIB ENTRY
inDiscards	busStatInDiscards
inOctets	busStatInOctets
inUcastFrms	busStatInUcastFrms
inMcastFrms	busStatInMcastFrm
frmTimeouts	busStatFrmTimeOuts
mcastSendRefused	busStatMcastSendRefused
mcastFwdFailure	busStatMcastFwdFailure

**Other Statistics:**

The following definitions are not MIB-related:

- inExplorer  
Number of Token-Ring explorer frames received by BUS
- inFlushReq  
Number of Flush request control frames received by BUS

## LES-BUS Console commands

outFlushReq\_mcastFwd  
Number of Flush request control frames forwarded by BUS on Multicast Forward VCC(s)

outFlushReq\_mcastSend  
Number of Flush request control frames forwarded by BUS on Multicast Send VCC

outUcastFrms\_mcastFwd  
Number of unicast frames forwarded by BUS on Multicast Forward VCC(s)

outUcastFrms\_mcastSend  
Number of unicast frames forwarded by BUS on Multicast Send VCC

outMcastFrms  
Number of multicast frames forwarded by BUS

outOctets  
Number of octets forwarded by BUS (includes both control and data)

mcastSendReleased  
Number of Multicast Send VCCs released by LEC/network for any reason

mcastFwdReleased  
Number of Multicast Forward VCCs released by LEC/network for any reason (this is release of entire point-to-multipoint VCC, not just one party)

mcastFwdPartyReleased  
Number of times call to party on Multicast Forward VCC was released by LEC/network for any reason

invalidProtocol\_droppedFrames  
Number of control frames dropped by BUS due to invalid protocol

verNotSup\_droppedFrames  
Number of control frames dropped by BUS due to incorrect version #

invalidOpcode\_droppedFrames  
Number of control frames dropped by BUS due to invalid opcode

invalidLecid\_droppedFrames  
number of frames (control or data) dropped by BUS due to invalid LECID

invalidSize\_droppedFrames  
Number of frames (control or data) dropped by BUS due to frame size being invalid

flushToBus\_droppedFrames  
Number of FLUSH request frames dropped by BUS because target ATM address was ATM address of BUS

incompleteSourceConnect\_droppedFrames  
Number of frames (control or data) dropped by BUS because source LEC had not completed the BUS connect phase

incompleteTargetConnect\_droppedFrames  
Number of frames (control or data) dropped by BUS because target LEC had not completed the BUS connect phase

noProxy\_droppedFrames

Number of "unknown" FLUSH request or non-multicast data frames dropped by BUS because the ELAN had no proxy LEC members

**Example:**

```
EXISTING LES-BUS+ sta display les les
ATM Forum LES MIB Statistics:
  joinOK: 2
  verNotSup: 0
  invalidReqParam: 0
  dupLanDest: 0
  dupAtmAddr: 0
  insRes: 0
  accDenied: 0
  invalidReqId: 0
  invalidLanDest: 0
  invalidAtmAddr: 0
  badPkts: 0
  outRegFails: 0
  leArpIn: 2
  leArpFwd: 0
Other Statistics:
  leArpAnswers: 2
  leArpRspFwd: 0
  topologyFwd: 0
  narpFwd: 0
  flushRspFwd: 0
  outJoinFails: 0
  regOK: 2
  unRegOK: 0
  outUnRegFails: 0
  proxyLeccs: 1
  nonProxyLeccs: 0
  macAddrMappings: 1
  rdMappings: 0
  atmAddrMappings: 1
  joinRetransmits: 0
  joinParmChanges: 0
  joinTimeouts: 0
  reRegs: 0
  ctldirRefused: 0
  ctldirReleased_err: 0
  ctldistFailure: 0
  ctldistReleased_err: 0
  ctldistPartyReleased_err: 0
  redundancyVccRefused: 0
  redundancyVccReleased: 0
  redundancyVccFailure: 0
  oam_droppedFrames: 0
  invalidSize_droppedFrames: 0
  invalidMarker_droppedFrames: 0
  invalidProtocol_droppedFrames: 0
  verNotSup_droppedFrames: 0
  invalidLecid_droppedFrames: 0
  unknownLecid_droppedFrames: 0
  invalidOpcode_droppedFrames: 0
  dupJoin_droppedFrames: 0
  incompleteSourceJoin_droppedFrames: 0
  incompleteTargetJoin_droppedFrames: 0
  noProxy_droppedFrames: 0
```

**ATM Forum LES MIB Statistics:**

The statistical counters for some fields generated by the **sta display les les** command map to MIB variables as follows:

## LES-BUS Console commands

LES DISPLAYED NAME -----	MIB ENTRY -----
joinOK	lesStatJoinOk
verNotSup	lesStatVerNotSup
invalidReqParam	lesStatInvalidReqParam
dupLanDest	lesStatDupLanDest
dupAtmAddr	lesStatDupAtmAddr
insRes	lesStatInsRes
accDenied	lesStatAccDenied
invalidReqId	lesStatInvalidReqId
invalidLanDest	lesStatInvalidLanDest
invalidAtmAddr	lesStatInvalidAtmAddr
badPkts	lesStatInBadPkts
outRegFails	lesStatOutRegFails
leArpIn	lesStatLeArpIn
leArpFwd	lesStatLeArpFwd

### Other Statistics:

The following definitions are not MIB-related:

leArpAnswers

Number of ARP requests answered by LES

leArpRspFwd

Number of ARP responses forwarded by LES

topologyFwd

Number of topology frames forwarded by LES

narpFwd

Number of NARP frames forwarded by LES

flushRspFwd

Number of flush response frames forwarded by LES

outJoinFails

Number of join responses transmitted with unsuccessful status values, includes retransmissions

regOK

Number of successful registration responses sent by LES, includes reregistrations

unRegOK

Number of successful unregistration responses sent by LES

outUnRegFails

Number of unregistration responses transmitted with unsuccessful status values

proxyLecs

Number of Proxy LECs currently joined to LES

nonProxyLecs

Number of Non-Proxy LECs currently joined to LES

regMacAddr

Number of MAC address mappings currently in database

regRd

Number of route descriptor mappings currently in database

regAtmAddr

Number of unique ATM addresses currently in mapping database



joinRetransmits  
Number of join response retransmissions

joinParmChanges  
Number of LEC ELAN memberships terminated because parms changed on subsequent JOIN request

joinTimeouts  
Number of join timeouts

reRegs  
Number of reregistrations

ctlDirRefused  
Number of Control Direct VCC call setup requests rejected by the LES for any reason

ctlDirReleased\_err  
Number of Control Direct VCCs released by LEC/network with cause code indicating error

ctlDistFailure  
Number of Control Distribute VCC requests made by LES that failed for any reason (includes calls to first and subsequent parties)

ctlDistReleased\_err  
Number of Control Distribute VCCs released by LEC/network due to error (this is release of entire point-to-multipoint VCC, not just one party)

ctlDistPartyReleased\_err  
Number of times call to party on Control Distribute VCC was released by LEC/ network with cause code indicating error

oam\_droppedFrames  
Number of OAM frames dropped by LES

invalidSize\_droppedFrames  
Number of frames dropped by LES due to frame size being invalid for a control frame

invalidMarker\_droppedFrames  
Number of frames dropped by LES due to invalid marker

invalidProtocol\_droppedFrames  
Number of frames dropped by LES due to invalid protocol

verNotSup\_droppedFrames  
Number of frames dropped by LES due to incorrect version #

invalidLecid\_droppedFrames  
Number of frames dropped by LES due to invalid LECID, these are NARP and topology requests

unknownLecid\_droppedFrames  
Number of frames dropped by LES due to unknown LECID, these are ARP and FLUSH responses

invalidOpcode\_droppedFrames  
Number of frames dropped by LES due to invalid opcode

## LES-BUS Console commands

### dupJoin\_droppedFrames

Number of duplicate join requests dropped by LES because processing of the original request had not completed

### incompleteSourceJoin\_droppedFrames

Number of frames dropped by LES because source LEC had not completed the JOIN phase

### incompleteTargetJoin\_droppedFrames

Number of frames dropped by LES because target LEC had not completed the JOIN phase

### noProxy\_droppedFrames

Number of "unknown" ARP requests dropped by LES because the ELAN had no proxy LEC members

### Example:

```
EXISTING LES-BUS+ sta di les lec-les lecid
LECID [0]? 1
ATM Forum LEC-LES MIB Statistics:
  recvs:                               3
  inRegReq:                             1
  inUnReg:                               0
  inLeArpUcast:                          0
  inLeArpBcast:                           1
  inLeArpResp:                            0
  inNArp:                                 0
Other Statistics:
  directedResp:                           3
  inLeArpRd:                              0
  inTopology:                             0
  inFlushResp:                            0
```

### ATM Forum LES MIB Statistics:

The statistical counters for some fields generated by the **sta di les lec-les** command map to MIB variables as follows:

LEC-LES DISPLAYED NAME	MIB ENTRY
recvs	lesLecRecvs
inRegReq	lesLecInRegReq
inUnReg	lesLecInUnReg
inLeArpUcast	lesLecInLeArpUcast
inLeArpBcast	lesLecInLeArpBcast
inLeArpResp	lesLecInLeArpResp
inNArp	lesLecInNArp

### Other Statistics:

The following definitions are not MIB-related:

#### directedResp

Number of responses sent directly to LEC on Control Direct VCC

#### inLeArpRd

Number of ARP requests for route descriptors received from LEC

#### inFlushResp

Number of FLUSH responses received from LEC

#### inTopology

Number of topology requests received from LEC

display source all *or* ip *or* ipx *or* netbios

Displays statistical data for Source Management.

**Example:**

```
EXISTING LES-BUS+ sta display source all
```

	IP	IPX	NetBIOS	Total
outNoRif:	0	0	0	0
outAre:	0	0	0	0
outSte:	0	0	0	0
outSrf:	1	0	0	1

The statistical counters for the **sta display source all** command map to MIB variables as follows:

TOTALS DISPLAYED NAME	MIB ENTRY
-----	-----
outNoRif	bcmBroadcastFramesDirectedNoRif
outAre	bcmBroadcastFramesDirectedAre
outSte	bcmBroadcastFramesDirectedSte
outSrf	bcmBroadcastFramesDirectedSrf
IP DISPLAYED NAME	MIB ENTRY
-----	-----
outNoRif	bcmIpBroadcastFramesDirectedNoRif
outAre	bcmIpBroadcastFramesDirectedAre
outSte	bcmIpBroadcastFramesDirectedSte
outSrf	bcmIpBroadcastFramesDirectedSrf
IPX DISPLAYED NAME	MIB ENTRY
-----	-----
outNoRif	bcmIpxBroadcastFramesDirectedNoRif
outAre	bcmIpxBroadcastFramesDirectedAre
outSte	bcmIpxBroadcastFramesDirectedSte
outSrf	bcmIpxBroadcastFramesDirectedSrf
NetBIOS DISPLAYED NAME	MIB ENTRY
-----	-----
outNoRif	bcmNbBroadcastFramesDirectedNoRif
outAre	bcmNbBroadcastFramesDirectedAre
outSte	bcmNbBroadcastFramesDirectedSte
outSrf	bcmNbBroadcastFramesDirectedSrf

## Stop

Use the **stop** command to stop the operation of a LES-BUS.

**Syntax:** stop

**Example:** stop ?

## Exit

Use the Exit command to return to the LE-SERVICES+ prompt.

**Syntax:** exit

**Example:** exit

## LECS Console Commands

An operating LECS may be created, deleted, or restarted. Certain operating parameters of the LECS may be modified. (These changes are lost on the next restart.) You can also search through the databases of the LECS or enter into the subenvironments of the LECS console.

Enter the following commands at the LECS console+ prompt:

<i>Table 24-3. LECS Monitoring Commands Summary</i>	
<b>Command</b>	<b>Function</b>
<b>? (Help)</b>	Lists the console commands or lists the actions associated with specific commands
<b>Create</b>	Creates a LECS from its configuration data (the configuration data must already exist)
<b>Delete</b>	Deletes the operating LECS
<b>ELANS</b>	Enters the LECS ELANS Console Environment
<b>List</b>	Displays the parameters of the operating LECS
<b>Memory</b>	Resets the short-term memory of the LECS
<b>Policies</b>	Enters the LECS Policies Console Environment
<b>Restart</b>	Restarts the LECS
<b>Search</b>	Searches the databases of the LECS
<b>Set</b>	Modifies an operating parameter of the LECS
<b>Statistics</b>	Resets or displays values of LECS counters
<b>Exit</b>	Returns to the previous prompt

## Help

Use the **? (help)** command to list the commands that are available from the current prompt level. You also can enter **?** after a specific command name to list its options.

### Example:

```
LECS console+ ?
create
delete
elans
list
memory
policies
restart
search
set
statistics
exit
LECS console+
```

## Create

Use this command to create an operating LECS from the configuration data. Only one LECS is permitted on the MSS Server. This command also creates all of the policies, ELANs, etc., for the LECS. These objects are created directly from the LECS configuration, described in “Commands for Configuring a LECS” on page 23-15. You can delete the LECS with the **delete** command.

**Syntax:** `create`

**Example:**

```
LECS console+ create
LECS created successfully
      created all configured LECS objects
LECS console+
```

## Delete

Use the **delete** command to delete an operating LECS. The LECS, along with all of its policies, ELANs, etc., is deleted from operation. You can recreate the LECS using either the **create** or the **restart** command.

**Syntax:** `ddelete`

**Example:**

```
LECS console+ delete
Delete LECS and all of its resources? [No]:yes
LECS deleted
LECS console+
```

## ELANS

Use the `elans` command to enter the LECS ELANs console environment where you can create the ELANs, LESSs, etc., known to this LECS.

**Syntax:** `elans`

**Example:**

```
LECS console+ elans
LECS ELANs console
LECS ELANs+
```

## List

Use this command to list the operating parameters of the LECS. Only the parameters of the LECS are listed - individual policies, ELANs, etc., must be accessed through submenus. The operating parameters of the LECS include its current state, an error log, the LECS ATM address, whether or not the LECS was able to register the ATM Forum well-known address with local switch, the UNI version being used, and the configuration parameters described at “Set” on page 24-36.

**Syntax:** `list`

### Example:

```

LECS console+ list
Status of LECS:
ATM device number:          0
State:                      Operating normally(88)
  Time of last state change: 00.24.50.03
  Elapsed time since last change: 00.15.41.42
Error Log:                  no err (0)
Local ATM address:
39840F00000000000000000000000000110005A00000B00

Well-known address:        (unable to confirm WKA registered with switch)

UNI version:               UNI Version 3.0
Validate best effort PCR:  No
Maximum config direct VCC reserved bandwidth:
                           0 Kbps
Maximum number of config direct VCCs to LECS:
                           128
Seconds before VCC declared idle: 60
Trace ATM address value:
0000000000000000000000000000000000000000000000000000000000000000

Trace ATM address mask:
FFFFFFFFFFFFFFFFFFFFFFFFFFFFFFFFFFFFFFFFFFFFFFFFFFFFFFFFFFFFFFFF
LECS console+

```

#### ATM device number

Number of the ATM interface over which the LECS is operating.

#### State:

The possible states of the LECS:

*Idle* - The LECS exists but is not functional. This is a temporary state of the LECS; if the idle state persists, either delete or restart the LECS.

*Initializing* - The LECS is initializing its memory.

*Activating ATM address* - The LECS has initiated registration of its ATM address with the local switch but has not received confirmation of the address registration.

*Activated ATM address* - The LECS has received confirmation that its ATM address is registered with the local switch.

*Getting UNI version* - The LECS is attempting to query the local switch to determine the UNI version.

*Got UNI version* - The LECS has determined the UNI version being used.

*ATM address deactivated* - The local ATM switch has deactivated the ATM address of the LECS. If this state persists, restart the LECS.

*ATM network down* - The ATM interface has detected that the ATM network is not functioning correctly. LECS operation should return to normal once the ATM network is operational.

*Operating normally* - The normal state of the LECS.

*Down due to error* - An error occurred that terminated the operation of the LECS. The error log contains information explaining the error. The LECS must be restarted.

*Polling status of well-known address* - Certain ATM switches let you register ATM addresses that do not use the same 13 octet ATM address prefix used by the switch. For such switches, dynamic registration of the ATM Forum's well-known LECS address is possible. During initialization,

the LECS always attempts to register the well-known address with the switch. This state indicates that the LECS is currently attempting this well-known address registration.

*Operating but rejecting VCCs* - The **set stop** command puts the LECS into this state where it rejects all configuration direct VCCs. Use the **set start** command to return to the normal operating state.

*State unknown!!!* - An error caused the state variable of the LECS to assume an unknown value. Restart or delete the LECS.

“Time of last...” and “Elapsed time since...”

These two fields indicate the last time that the LECS changed its state. The field is in the format hh.mm.ss.dd where hh is hours, mm is minutes, ss is seconds, and dd is hundredths of seconds. The first field lists the time that elapsed between the system initialization and the last state change, while the second field lists the time that elapsed since the last state change.

Error Log:

Describes the error that caused the LECS to enter the 'Down due to error' state. This information is used for diagnostic purposes.

Local ATM address:

ATM address of the LECS consisting of the first 13 octets from the network prefix of the local ATM switch, and appending the configured ESI and selector value. The ATM address is displayed only if it has been successfully registered with the local ATM switch.

Well-known address:

The well-known address of the LECS. The LECS attempts to register the well-known address dynamically with the ATM switch. If this dynamic registration succeeds, or if the LECS begins to receive calls to the well-known address (indicating that some other entity has registered the LECS with the local ATM switch), then this field contains the ATM Forum well-known ATM address.

UNI version:

The UNI version being used by the LECS.

Validate best effort PCR

See the **set validate** command.

Maximum config direct VCC reserved bandwidth:

See the **set reserved** command.

Maximum number of config direct VCCs to LECS:

See the **set maximum** command.

Seconds before VCC declared idle:

See the **set vcc** command.

Trace ATM address...

See the **set trace** command.

### Memory

Use this command to clear the LECS short-term memory. The short-term memory of the LECS functions in both the redundancy and security aspects of the MSS Server LAN Emulation Service. For additional information on redundancy and security, see "LAN Emulation Reliability" on page 18-15. The **memory** command can be used to reinitialize the short-term memory without restarting the LECS.

**Syntax:** memory clear

**Example:**

```
LECS console+ memory clear
Cleared short-term memory of LECS
LECS console+
```

### Policies

Use the **policies** command to enter the LECS Policies Console environment where you can work closely with the policies guiding the LEC-to-LES assignment procedure of the LECS. Policies can be created, deleted, and displayed, and various policy-related counters can be modified.

**Syntax:** policies

**Example:**

```
LECS console+ policies
LECS policies console
LECS policies+
```

### Restart

Use this command to restart or create the LECS. The **restart** command stops an operating LECS, frees its resources, and reinitializes/restarts the LECS. You are prompted to either keep the current databases or to rebuild them from the static configuration data when the LECS restarts.

**Syntax:** restart

**Example:**

```
LECS console+ restart
( 1) rebuild
( 2) retain
Retain current LECS databases
or rebuild from SRAM [1]?2
LECS restarted successfully
LECS console+
```

### Search

Use this command to search for LES or policy value information in the LECS databases. For example, if you wanted to know to which LES the LEC with ATM address 39.00.82.48.29.10.39.38.10.AB.CD.E1.02.FA.83.29.00.00.00.1D would be assigned, use the command **search atm**, or **search atm 39.00.82.48.29.10.39.38.10.AB.CD.E1.02.FA.83.29.00.00.00.1D**

**Syntax:** search atm  
les  
mac  
name



route

Use the **search atm** command to search the LECS database of client ATM address prefixes. The output lists the longest prefix of that address found in the database, the LES associated with that prefix, and the ELAN associated with the LES.

**Note:** You can also search for a LES ATM address if you entered it as a non-local LES. See “Detailed Configuration of an ELAN at the LECS” on page 23-23 for a description of local and non-local LESs.

**Syntax:** search atm

**Example:**

```
LECS console+ search atm
ATM prefix to search for [ ]?39.00.82.48.29.10.39.38.10.AB.CD.E1.02.FA.83.29.00.00.00.1D
ATM address prefix 39.00.82.48.29.10.39.38.10.AB.CD.E1.02.FA.83.29.00.00.00.1D
  longest prefix 39.00.82.48.29.10.39.38.10.AB.CD.E1.02.FA.83.29.00.00.00.1D
    for LES address Local LES for: Accounting Ethernet Elan
      for ELAN 'Accounting Ethernet Elan'
LECS console+
```

Use the **search les** command to search for a given LES address in the LECS database of LES ATM addresses. The output lists the ELAN associated with the LES.

**Syntax:** search les

**Example:**

```
LECS console+ search les
LES to search for [ ]?39.99.99.99.99.99.99.99.01.01.01.02.02.02.84.92.84.92.83.83.03
LES address 39.99.99.99.99.99.99.99.01.01.01.02.02.02.84.92.84.92.83.83.03
  for ELAN 'R&D Token Ring Elan'
LECS console+
```

Use the **search mac** command to search for a given MAC address in the LECS database of client MAC addresses. You are prompted to enter whether the MAC address was entered in token-ring or Ethernet bit format (the difference being which bit is most significant). The output lists the LES associated with the MAC address and the ELAN associated with that LES.

**Syntax:** search mac

**Example:**

```
LECS console+ search mac
MAC address to search for [ ]?12.34.12.34.12.35
  ( 1) Ethernet bit-order
  ( 2) Token ring bit-order
Bit order used by MAC address [1]?1
MAC address 12.34.12.34.12.35
  for LES address Local LES for: Accounting Ethernet Elan
    for ELAN 'Accounting Ethernet Elan'
LECS console+
```

Use the **search name** command to search for a given ELAN name in the LECS database of ELAN name policy values. The ELAN name policy value is the ELAN name used by clients in their configuration requests. The output lists the LES associated with the given ELAN name, and the ELAN associated with the LES.

**Syntax:** search name

## LECS Console Commands

### Example:

```
LECS console+ search name
ELAN name to search for [ ]?R&D Elan
ELAN name 'R&D Elan'
    for LES address 39.99.99.99.99.99.01.01.01.02.02.02.84.92.84.92.83.83.03
    for ELAN 'R&D Token Ring Elan'
LECS console+
```

Use the **search route** command to search for a route descriptor in the LECS database of client route descriptors. The output lists the LES associated with that route descriptor, and the ELAN associated with that LES.

**Syntax:** search route

### Example:

```
LECS console+ search route
Route descriptor to search for [ ]?39.02
Route descriptor 39.02
    for LES address 39.99.99.99.99.99.01.01.01.02.02.02.84.92.84.92.83.83.03
    for ELAN 'R&D Token Ring Elan'
LECS console+
```

## Set

Use this command to set various operating parameters of the LECS. These parameters take effect immediately but are not saved when you restart the LECS or the router.

**Syntax:** set maximum  
reserved  
start  
stop  
trace ...  
validate  
vcc

Use the **set maximum** command to set the maximum number of simultaneous configuration direct VCCs permitted by the LECS. When this number is exceeded, the LECS releases all VCCs not used within the VCC idle time. VCCs that have been used within the VCC idle time are not released.

### Example:

```
LECS console+ set maximum
Maximum number of simultaneous VCCs [128]?64
LECS modified
LECS console+
```

Use the **set reserved** command to set the maximum reserved bandwidth on a configuration direct VCC. The LECS will not accept reserved bandwidth connections specifying a reserved bandwidth that is larger than this maximum.

### Example:

```
LECS console+ set reserved
Configuration direct maximum reserved bandwidth (in Kbps) [0]?1000
LECS modified
LECS console+
```

Use the **set start** command to move the LECS into a state where it accepts VCCs (this is its normal operating state).

**Example:**

```
LECS console+ set start
Reject all incoming VCCs? [No]no
LECS now accepting calls
LECS console+
```

Use the **set stop** command to move the LECS into a state where it rejects all incoming VCCs. You should put the LECS in such a state before creating or deleting ELANs, policies, etc. Otherwise, changing these other structures could result in a client issuing two identical configuration requests, but being assigned to different LESs with each request, because the modifications changed the LECS databases between configuration requests.

**Example:**

```
LECS console+ set stop
Reject all incoming VCCs? [Yes]:yes
LECS rejecting all VCCs
LECS console+
```

Use the **set trace** command to change the “trace mask” or the “trace value.” The trace mask and trace value are used by the LECS to determine over which VCCs packet tracing should be active. For each VCC, the LECS compares the logical AND of the trace value and the trace mask with the logical AND of the calling ATM address and the trace mask. If the resulting bit strings are identical, then the LECS should perform packet tracing on that VCC. To activate packet tracing over all VCCs, use a mask of all zeros. Packet tracing over particular VCCs is indicated by using a more specific trace mask and trace value. Packet tracing must also be enabled for the LECS subsystem through the ELS console or configuration. For additional information, refer to Chapter 11, “Using and Configuring the Event Logging System (ELS)” on page 11-1 and Chapter 12, “Monitoring the Event Logging System (ELS)” on page 12-1.

In the following examples, packet tracing is used over all VCCs with a calling party ATM address beginning with 39.84.0f.00.00.00.00.01.01.d0.d0.58.24

**Example:**

```
LECS console+ set trace mask
Trace ATM addr mask [ ]?ff.ff.ff.ff.ff.ff.ff.ff.ff.ff.ff.00.00.00.00.00.00
LECS modified
LECS console+
```

**Example:**

```
LECS console+ set trace value
Trace ATM addr value [ ]?39.84.0f.00.00.00.00.01.01.d0.d0.58.24.00.00.00.00.00.00
LECS modified
LECS console+
```

Use the **set validate** command to determine whether the LECS validates the peak cell rate of best-effort connections. If this parameter is true, the LECS rejects connections specifying a peak cell rate greater than the line rate of the ATM interface. Clients specifying such a peak cell rate expect that they may use more bandwidth than is available *which can adversely affect network performance*. Setting this parameter to true may create interoperability problems with clients exhibiting this behavior.

## LECS Console Commands

### Example:

```
LECS console+ set validate
Validate best effort peak cell rate? [No]:yes
LECS modified
LECS console+
```

Use the **set vcc** command to set the VCC idle time of the LECS.

**Syntax:** `set vcc`

### Example:

```
LECS console+ set vcc
Time (in seconds) before a VCC is declared idle [60]?30
LECS modified
LECS console+
```

## Statistics

Use the **statistics** command to reset or to display many of the LECS counters.

**Syntax:** `statistics clear`

`list`

Use the **statistics clear** command to reset the counters of the LECS.

### Example:

```
LECS console+ statistics clear
LECS statistics cleared
LECS console+
```

Use the **statistics list** command to display the counters of the LECS.

### Example:

```
LECS console+ statistics list
LECS has:
  13 ELAN(s)
  6 policy(ies) at 6 priority(ies)
LECS has 0 configure direct VCCs
  has accepted 434 VCCs and rejected 4 VCCs
  0 VCCs have been dropped by LECS, 434 dropped by caller
  has exceeded its maximum number of VCCs 0 times
LECS discarded frames: 16
LECS responses by status (zero responses if status not displayed)

  Success( 0) : 512
  Invalid request parameters( 2) : 8
  Invalid REQUESTOR-ID( 8) : 4
  Invalid LAN Destination( 9) : 12
  Invalid ATM Address(10) : 4
  LE_CONFIGURE Error(21) : 12
LECS console+
```

LECS has:

This is a two-line description of counters for the number of ELANs, policies, and policy priority levels at the LECS. These counters are not reset with the **statistics clear** command.

LECS has 0 configure direct VCCs

Describes counters on the VCC use of the LECS. The counter for the current number of VCCs will not be reset by the **statistics clear** command, but the other counters will.

LECS discarded frames:

Shows the number of frames that have been discarded by the LECS.

LECS responses by status ...

Describes counters for the number of responses sent by the LECS with various status values. For each possible status there is a counter. The counter value is displayed only if it is non-zero.

## Exit

Use the **exit** command to return to the previous prompt.

**Syntax:** `exit`

**Example:** `exit`

## LECS Policies Console Commands

The LECS Policy Console environment is characterized by the `LECS policies+` prompt. From this environment, you can monitor and control the policies guiding the LEC-to-LES assignment procedure of the LECS. Policies can be created, deleted, or displayed. Also, certain counters associated with the policies can be displayed or reset.

Enter commands at the `LECS policies+` prompt which you can get to from the `LECS console+` prompt for the specified LES-BUS.

*Table 24-4. LECS Policies Monitoring Commands Summary*

Command	Function
<b>? (Help)</b>	Lists the console commands or lists the actions associated with specific commands
<b>Create</b>	Creates a policy for the operating LECS (the policy must already exist in the configuration data).
<b>Delete</b>	Deletes a policy for the operating LECS.
<b>List</b>	Displays or resets certain counters associated with the LECS policies.
<b>Exit</b>	Returns to the LECS console environment.

## Help

Use the **? (help)** command to list the commands that are available from the current prompt level. You also can enter a **?** after a specific command name to list its options.

**Syntax:** `?`

**Example:** `?`

```
LECS policies+ ?
create
delete
elans
list
memory
policies
restart
search databases
set
statistics
exit
```

## Create

Use the **create** command to create a policy from the configuration data. Note that the policy must exist in the static configuration before it can be created. You are prompted for the policy that you wish to create. If you specify the `All enbld pols` choice, then all policies that are enabled in the static configuration are created.

**Syntax:** `create`

**Example: create**

```
LECS policies+ create
( 1) All enbld pols
( 2) 100 byAtmAddr
( 3) 200 byMacAddr
( 4) 300 byRteDesc
( 5) 400 byElanNm
( 6) 1000 byLanType
( 7) 1100 byPktSize
Choice of policy [1]? 5
Policy created: '400 byElanNm '
LECS policies+
```

## Delete

Use the **delete** command to delete a policy from the operating LECS. You will be prompted for the policy that you wish to delete. If you specify the All active pols choice, all policies of the LECS are deleted.

**Syntax:** `delete`

**Example: delete**

```
LECS policies+ delete
( 1) All active pols
( 2) 100 byAtmAddr
( 3) 200 byMacAddr
( 4) 300 byRteDesc
( 5) 400 byElanNm
( 6) 1000 byLanType
( 7) 1100 byPktSize
Choice of policy [1]? 3
Deleted policy: '200 byMacAddr'
LECS policies+
```

## Elans

Use the **elans** command to

## List

Use the list command to list the policies of the active LES.

**Syntax:** `list`

**Example: list**

```
LECS policies+ list

Policy listing....

Priority: 100 Policies: byAtmAddr
Priority: 300 Policies: byRteDesc
Priority: 400 Policies: byElanNm
Priority: 1000 Policies: byLanType
Priority: 1100 Policies: byPktSize
LECS policies+
```

### Memory

Use this command to clear the LECS Policies short-term memory. The **memory** command can be used to reinitialize the short-term memory without restarting the LECS.

**Syntax:** `memory clear`

**Example:**

```
LECS policies+ memory clear
Cleared short-term memory of LECS Policies
LECS policies+
```

### Policies

Use the **policies** command to work with the policies guiding the LEC-to-LES assignment procedure of the LECS. Policies can be created, deleted, and displayed, and various policy-related counters can be modified.

**Syntax:** `policies`

### Restart

Use the **restart** command to

Use this command to restart or create the LECS policies. The **restart** command stops an operating LECS policy, frees its resources, and reinitializes/restarts the LECS policy. You are prompted to either keep the current databases or to rebuild them from the static configuration data when the LECS restarts.

**Syntax:** `restart`

### Search databases

Use the **Searchdatabases** command to search for policy information in the LECS policy databases.

**Syntax:** `search database`

### Set databases

Use the **Set databases** command to set information about policies databases.

**Syntax:** `set database`

### Statistics

Use the **statistics clear** command to reset the counters associated with the LECS policies. You may clear the statistics of all policies, or of the policies at a certain priority.



**Syntax:** statistics clear

**Example:** statistics clear

```
LECS policies+ statistics clear
( 1) All active policies
( 2) 100 byAtmAddr
( 3) 300 byRteDesc
( 4) 400 byElanNm
( 5) 1000 byLanType
( 6) 1100 byPktSize
Choice of policy [1]? 3
Cleared stats of 1 priority levels
LECS policies+
```

Use the **statistics list** command to display the counters associated with the LECS policies. You may display the counters for all policies, or only for the policies at a certain priority level.

**Syntax:** statistics list

**Example:** statistics list

```
LECS policies+ statistics list
( 1) All active policies
( 2) 100 byAtmAddr
( 3) 300 byRteDesc
( 4) 400 byElanNm
( 5) 1000 byLanType
( 6) 1100 byPktSize
Choice of policy [1]? 4

Priority: 400 Policies: byElanNm
#policies at this priority: 1
#times assigned by policy: 158
#times policy failed: 253

LECS policies+
```

**Priority**

Counters are maintained for each priority level.

**#policies at this priority**

This counter is not reset by the statistics clear command.

**#times assigned by policy**

This counts the number of times that the LECS used the policies at this priority level to assign a client to a LES.

**#times policy failed**

This counts the number of times that the LECS attempted to use the policies at this priority level to assign a client to a LES, but failed.

## Exit

Use the Exit command to return to the LES-BUS Config for ELAN 'n'> prompt.

**Syntax:** exit

**Example:** exit

---

## Monitoring ELANs at the LECS

The LECS ELAN Console environment is characterized by the LECS ELANs+ prompt. From this environment, one can create, delete, and display the ELANs of the LECS. ELAN counters can be displayed and reset. There is also a subenvironment in which one can work with the details of the ELAN, including the LESs, policy values, and so forth.

Enter commands at the LECS ELANs+ prompt.

*Table 24-5. ELAN Monitoring Commands Summary*

Command	Function
<b>? (Help)</b>	Lists the console commands or lists the actions associated with specific commands.
<b>Create</b>	Creates an ELAN from its configuration. (The configuration data must already exist.)
<b>Delete</b>	Deletes an ELAN from the operating LECS.
<b>List</b>	Lists all ELANs of the LECS.
<b>Select ELAN</b>	Selects an ELAN to monitor in more detail.
<b>Statistics</b>	Clears or displays the ELAN counters.
<b>Exit</b>	Returns to the previous prompt.

## Help

Use the **? (help)** command to list the commands that are available from the current prompt level. You also can enter a ? after a specific command name to list its options.

**Syntax:** ?

**Example:** ?

```
? (HELP)
CREATE
DELETE
LIST
SELECT
STATISTICS
EXIT
```

## Create

Use the **create** command to create an ELAN for the LECS from the ELAN configuration data. The configuration data must already exist in static memory. For information on entering ELAN configuration data, see Chapter 23, "Configuring LAN Emulation Services" on page 23-1. Creating the ELAN results in the creation of all LESs, TLVs, and policy values for that ELAN. If you select the All enabled ELANs choice, then all ELANs enabled in the static configuration are created.

**Syntax:** create

**Example: create**

```
LECS ELANs+ create
( 1) All enabled ELANs
( 2) Accounting Ethernet Elan
( 3) Finance Ethernet Elan
( 4) R&D Token Ring Elan
Choice of ELAN [1]? 2
ELAN created 'Accounting Ethernet Elan'
Created TLVs for ELAN 'Accounting Ethernet Elan'
Created LESSs for ELAN 'Accounting Ethernet Elan'
```

**Delete**

Use the **delete** command to delete an ELAN from the LECS. The LESSs, TLVs, and policy values of that ELAN are also deleted. You are prompted for the ELAN to delete. If you select the 'All Active ELANs' choice, then all ELANs of the LECS are deleted.

**Syntax:** `delete`

**Example: delete**

```
LECS ELANs+ delete
( 1) All active ELANs
( 2) Finance Ethernet Elan
( 3) R&D Token Ring Elan
( 4) Accounting
Ethernet Elan Choice of ELAN [1]? 2
Deleted ELAN 'Finance'
```

**List**

Use the **list** command to display a summary of the ELANs on the operating LECS.

**Syntax:** `list`

**Example: list**

```
LECS ELANs+ list

ELAN listing...

Type      MFS  ELAN name
=====  =====
TokenRing 4544 'R&D Token Ring Elan'
Ethernet  1516 'Accounting Ethernet Elan'
```

**Select ELAN**

Use the **select** command to enter into the LECS ELAN Details Console environment. In this environment, you work more closely with a particular ELAN. The monitoring of LESSs, TLVs, and policy values is performed in this environment. You will be prompted to select an ELAN.

**Syntax:** `select`

**Example: select**

```
LECS ELANs+ select
( 1) R&D Token Ring Elan
( 2) Accounting Ethernet Elan
( 3) Finance Ethernet Elan
Choice of ELAN [1]? 2
ELAN 'Accounting Ethernet Elan' selected for detailed console
ELAN 'Accounting Ethernet Elan' selected+
```

## Statistics

Use the **statistics** command to display or reset the counters associated with each ELAN.

**Syntax:** `statistics` `clear`  
`list`

**clear** resets the counters associated with an ELAN. You can clear the counters for all ELANS, or for a selected ELAN.

**Example: statistics clear**

```
LECS ELANs+ statistics clear
( 1) All active ELANs
( 2) R&D Token Ring Elan
( 3) Accounting Ethernet Elan
( 4) Finance Ethernet Elan
Choice of ELAN [1]? 2
Cleared stats of 1 ELANs
```

**list** displays the ELAN counters. You can display the counters for all ELANs or for a selected ELAN.

**Example: statistics list**

```
LECS ELANs+ statistics list
( 1) All active ELANs
( 2) R&D Token Ring Elan
( 3) Accounting Ethernet Elan
( 4) Finance Ethernet Elan
Choice of ELAN [1]? 3
```

```
Type      MFS  ELAN name
=====
Ethernet  1516 'Accounting Ethernet Elan'
# TLVs: 0
# bytes in TLV data: 0
# LES ATM addresses: 1
```

Where:

# TLVs

is the number of TLVs which will be returned to clients assigned to this ELAN.

# bytes in TLV data

is the total size of the TLV information which will be returned to clients assigned to this ELAN.

# LES ATM addresses

is the number of LESs currently serving this ELAN.

## Exit

Use the **exit** command to return to the LECS Console environment.

**Syntax:** `exit`

**Example:** `exit`

## Monitoring ELAN Details at the LECS

The LECS ELAN Details Console environment is characterized by the ELAN 'elan\_name' selected+, where *elan\_name* is the name of the ELAN with which you are currently working. In this environment, you can modify the operational characteristics of the selected ELAN. Objects associated with the ELAN are also monitored and controlled in this environment. Such objects include:

- LESs
- TLVs
- Policy values

Enter commands at the LES-BUS Config for ELAN 'n'> prompt for the specified LES-BUS.

*Table 24-6. ELAN Details Monitoring Commands Summary*

Command	Function
<b>? (Help)</b>	Lists the console commands or lists the actions associated with specific commands
<b>LESs</b>	Monitor and control the LESs for this ELAN.
<b>List</b>	Display a summary of the ELAN.
<b>Policy</b>	Monitor and control the policy values assigned to any LES for this ELAN.
<b>Set</b>	Change the ELAN name, maximum frame size, or type of the ELAN.
<b>TLVs</b>	Monitor and control the TLVs which are returned to the clients assigned to this ELAN.
<b>Exit</b>	Return to the LECS ELANs Console environment.

## Help

Use the **? (help)** command to list the commands that are available from the current prompt level. You also can enter a ? after a specific command name to list its options.

**Syntax:** ?

**Example:** ?

```
ELAN 'R&D Token Ring Elan' selected+ ?
LESs
LIST
POLICY VALUEs
SET
TLVs
EXIT
```

## LES

Use the **les** command to monitor and control the LES ATM addresses which represent the LESs serving this ELAN. Note that no monitoring or control of the actual LES or BUS occurs. This command monitors and controls only the LES ATM address information which is returned to clients.

## Monitoring ELAN Details at the LECS

**Syntax:** `les`            `create`  
                              `delete`  
                              `list`  
                              `set . . .`  
                              `statistics . . .`

### create

Use the **les create** command to create LES ATM address information from the configuration. Note that configuration data must already exist (refer to Chapter 23, “Configuring LAN Emulation Services” on page 23-1.). You will be prompted to select the LES ATM address to create. Creation of this address information also creates all policy value information associated with that LES. If you select the ‘All enabled LESs’ choice, then all LESs which are enabled in static memory for this ELAN will be created.

#### Example: les create

```
ELAN 'R&D Token Ring Elan' selected+ les create
( 1) All enabled LESs
( 2) 39.99.99.99.99.99.01.01.01.02.02.02.84.92.84.92.83.83.03
( 3) Local LES for: R&D Token Ring Elan
Choice of LES [1]? 3
LES created: Local LES for: R&D Token Ring Elan
Created all values for LES Local LES for: R&D Token Ring Elan
```

### delete

Use the **les delete** command to delete a LES ATM address from the LECS. The policy value information associated with that LES is also deleted. You must select the LES ATM address to delete. If you select the ‘All active LESs’ choice, then all LESs associated with this ELAN will be deleted.

#### Example: les delete

```
ELAN 'R&D Token Ring Elan' selected+ les delete
( 1) All active LESs
( 2) 39.99.99.99.99.99.01.01.01.02.02.02.84.92.84.92.83.83.03
( 3) Local LES for: R&D Token Ring Elan
Choice of LES [1]? 3
LES deleted: Local LES for: R&D Token Ring Elan
```

### list

Use the **les list** command to display the LES ATM address information associated with the selected ELAN.

#### Example: les list

```
ELAN 'R&D Token Ring Elan' selected+ les l
Primary ATM address:
39.99.99.99.99.99.01.01.01.02.02.02.84.92.84.92.83.83.03
  bckup ATM address: (no backup provided)
Primary ATM address: Local LES for: R&D Token Ring Elan
  bckup ATM address: (no backup provided)
```

### set *primary/backup*

Use the **les set** command to change the ATM address of a primary or backup LES. You must select the LES ATM address information to modify. Refer to Chapter 23, “Configuring LAN Emulation Services” on page 23-1 for an explanation of a primary and backup LES ATM addresses.

**Example: les set primary**

```

ELAN 'R&D Token Ring Elan' selected+ les set primary
( 1) 39.99.99.99.99.99.99.01.01.01.02.02.02.84.92.84.92.83.83.03
( 2) Local LES for: R&D Token Ring Elan
Choice of LES [1]?
( 1) Local
( 2) Remote
Primary LES is [2]?
If primary LES is remote, enter ATM address

[39.99.99.99.99.99.99.01.01.01.02.02.02.84.92.84.92.83.83.03]?
39.99.99.99.99.99.99.01.01.01.02.02.02.84.92.84.92.83.83.05
Primary LES ATM address modified

```

**statistics clear OR list**

Use the **les statistics** command to display or reset the counters associated with LESs.

**clear**

Use the **les statistics clear** command to reset the counters of the LESs. You may reset the counters for all of the LESs, or a selected LES.

**Example: les statistics clear**

```

ELAN 'R&D Token Ring Elan' selected+ les statistics clear
( 1) All active LESs
( 2) 39.99.99.99.99.99.99.01.01.01.02.02.02.84.92.84.92.83.83.05
( 3) Local LES for: R&D Token Ring Elan
Choice of LES [1]? 2
Cleared stats of 1 LESs

```

**list**

Use the **les statistics list** command to display the various counters associated with each LES. You may display the counters of all LESs or a selected LES.

**Example: les statistics list**

```

ELAN 'R&D Token Ring Elan' selected+ les statistics list
( 1) All active LESs
( 2) 39.99.99.99.99.99.99.01.01.01.02.02.02.84.92.84.92.83.83.05
( 3) Local LES for: R&D Token Ring Elan
Choice of LES [1]? 2

Primary ATM address:
39.99.99.99.99.99.99.01.01.01.02.02.02.84.92.84.92.83.83.05
# ATM prefixes:          5 # MAC addresses:          6
# Route descriptors:     4 # Lan types:          1
# Packet sizes:          2 # ELAN names:         4
# LECs assigned to primary LES address: 0
# LECs assigned to backup LES address: 0
# LECs assigned by local check: 0

```

**Note:**

- The first six counters are the number of policy values in the LECS database which are associated with this LES. There is one counter for each type of policy value, and these counters are not reset with the **les statistics clear** command.
- The # LECs assigned to primary LES address field indicates the number of clients which have been given the LES ATM address information of this primary LES. This counter only records the assignment if the primary LES ATM address is a non-local LES.
- The # LECs assigned to backup LES address field indicates the number of clients which have been given the LES ATM address

## Monitoring ELAN Details at the LECS

information of this backup LES. This counter only records the assignment if the backup LES ATM address is a non-local LES.

- The # LECs assigned by `local` check field indicates the number of clients which have been given LES ATM address information obtained by searching the LES-BUSs local to this MSS Server. After the LECS decides to which LES the client belongs, it queries the LES-BUSs on the MSS Server for the ATM address of an active LES for this ELAN. If there is a local LES-BUS serving this ELAN, either as a primary or backup, then the LECS obtains the definitive LES serving the ELAN. Otherwise, the LECS must use its heuristic redundancy algorithm.

## List

Use this command to display a summary of the selected ELAN, including its name, maximum frame size, and type.

**Syntax:** `list`

**Example:** `list`

```
ELAN 'R&D Token Ring Elan' selected+ list

ELAN name:      'R&D Token Ring Elan'
ELAN type:      TokenRing
Max frame size: 4544
```

## Policy

Use this command to create, delete, or display the policy values assigned to LESs for this ELAN.

`create`

Use the **policy create** command to create an active binding between a policy value and a LES. The policy values must already exist in the static configuration (see Chapter 23, “Configuring LAN Emulation Services” on page 23-1). Policy values are used to assign requesting clients to specific LESs. You will be prompted to select the policy value to create. If you choose the ‘All enabled values’ option, then all policy values of that type which exist in the static configuration will be created.

**Syntax:** `policy create pv_type`

Where `pv_type` is one of:

- ESI/SEL of ATM address
- FRAME size
- MAC address
- NAME of ELAN
- PREFIX of ATM address
- ROUTE descriptor
- TYPE of ELAN



**Example: policy create mac**

```

ELAN 'R&D Token Ring Elan' selected+ policy create mac
( 1) All enabled MAC values
( 2) 29.29.29.93.92.01 to
39.99.99.99.99.99.01.01.01.02.02.02.84.92.84.92.83.83.03
( 3) 29.29.29.93.92.02 to
39.99.99.99.99.99.01.01.01.02.02.02.84.92.84.92.83.83.03
( 4) 29.29.29.93.92.03 to
39.99.99.99.99.99.01.01.01.02.02.02.84.92.84.92.83.83.03
( 5) 29.29.29.93.92.04 to
39.99.99.99.99.99.01.01.01.02.02.02.84.92.84.92.83.83.03
( 6) 29.29.29.93.92.05 to
39.99.99.99.99.99.01.01.01.02.02.02.84.92.84.92.83.83.03
( 7) 29.29.29.93.92.06 to
39.99.99.99.99.99.01.01.01.02.02.02.84.92.84.92.83.83.03
MAC address [1]? 4
MAC address value created:
29.29.29.93.92.03 to 39.99.99.99.99.99.01.01.01.02.02.02.84.92.84.92.83.83.03

```

**delete**

Use this command to delete active policy values. You will be prompted for the policy value to delete. If you select the 'All active values' option, then all policy values of that type will be deleted.

**Syntax: policy delete pv\_type**

Where *pv\_type* is one of:

- ESI/SEL of ATM address
- FRAME size
- MAC address
- NAME of ELAN
- PREFIX of ATM address
- ROUTE descriptor
- Type of ELAN

**Example: policy delete route**

```

ELAN 'R&D Token Ring Elan' selected+ policy delete route
( 1) All active route descriptor values
( 2) 39.92 to
39.99.99.99.99.99.01.01.01.02.02.02.84.92.84.92.83.83.03
( 3) 39.93 to
39.99.99.99.99.99.01.01.01.02.02.02.84.92.84.92.83.83.03
( 4) 39.02 to
39.99.99.99.99.99.01.01.01.02.02.02.84.92.84.92.83.83.03
( 5) 39.03 to
39.99.99.99.99.99.01.01.01.02.02.02.84.92.84.92.83.83.03
Route descriptor [1]? 4
Deleted route descriptor value:
39.02 to 39.99.99.99.99.99.01.01.01.02.02.02.84.92.84.92.83.83.03

```

**list**

Use this command to list the active policy values for this ELAN.

**Syntax: policy list pv\_ty pe**

Where *pv\_type* is one of:

- ESI/SEL of ATM address
- FRAME size
- MAC address
- NAME of ELAN
- PREFIX of ATM address
- ROUTE descriptor
- TYPE of ELAN

## Monitoring ELAN Details at the LECS

### Example: policy list name

```
ELAN 'R&D Token Ring Elan' selected+ policy list name

ELAN name => LES
=====
'R&D Elan'
=> 39.99.99.99.99.99.01.01.01.02.02.02.84.92.84.92.83.83.03
'R&D'
=> 39.99.99.99.99.99.01.01.01.02.02.02.84.92.84.92.83.83.03
'R & D'
=> 39.99.99.99.99.99.01.01.01.02.02.02.84.92.84.92.83.83.03
'R&D Token Ring Elan'
=> 39.99.99.99.99.99.01.01.01.02.02.02.84.92.84.92.83.83.03
```

## Set

Use this command to change the ELAN name, maximum frame size, or type. These modifications do not affect the static configuration and are lost on a restart of the LECS or router.

**Syntax:** set frame  
name  
type

### frame

Use this command to change the maximum frame size of the selected ELAN.

### Example: set frame

```
ELAN 'R&D Token Ring Elan' selected+ set frame
( 1) 1516
( 2) 4544
( 3) 9234
( 4) 18190
Maximum frame size of ELAN [2]? 3
Attempting to modify max frame size...ELAN modified
```

### name

Use this command to change the name of the selected ELAN.

### Example: set name

```
ELAN 'R&D Token Ring Elan' selected+ set name
Name of ELAN [R&D Token Ring Elan]? R&D Token Ring Elan 1
Attempting to modify ELAN name...ELAN modified
```

### type

Use this command to change the type of the selected ELAN.

### Example: set type

```
ELAN 'R&D Token Ring Elan 1' selected+ set type
( 1) Ethernet
( 2) TokenRing
Type of ELAN [2]? 2
Attempting to modify ELAN type...ELAN modified
```

## TLVs

Use this command to create, delete, and list the TLVs for this ELAN. These are the TLVs which will be returned to each client assigned to this ELAN.

**Syntax:** TLV create  
dele~~t~~e  
list

**create**

Use this command to create a TLV from the configuration data. The TLV must already exist in the static configuration. See Chapter 23, “Configuring LAN Emulation Services” on page 23-1 for information on creating a static configuration. You will be prompted to select the TLV to create. If you select the ‘All enabled TLVs’ option, all TLVs enabled in the static configuration for this ELAN will be created. The TLVs are displayed in the format ‘T type\_id type\_description L length V value’ where

- *type\_id* is the 4 octet type identifier
- *type\_description* is a description of the TLV
- *length* is the number of octets of information in the TLV
- *value* is the value stored in the TLV.

**Example: tlv create**

```
ELAN 'R&D Token Ring Elan' selected+ tlv create
( 1) All enabled TLVs
( 2) T x00A03E01 C7 : Control timeout (sec)      L 2  V 60
( 3) T x00A03E04 C12: VCC timeout period (sec)   L 4  V 600
( 4) T x00A03E05 C13: Maximum retry count       L 2  V 2
TLV Choice [1]? 2
TLV created: T x00A03E01 C7 : Control timeout (sec)      L 2  V 60
```

**delete**

Use this command to delete a TLV. The TLV will no longer be returned to the clients assigned to this ELAN. You will be prompted to choose the TLV to delete. If you choose the ‘All active TLVs’ option, then all TLVs for this ELAN are deleted.

**Example: tlv delete**

```
ELAN 'R&D Token Ring Elan' selected+ tlv delete
( 1) All active TLVs
( 2) T x00A03E01 C7 : Control timeout (sec)      L 2  V 60
( 3) T x00A03E04 C12: VCC timeout period (sec)   L 4  V 600
( 4) T x00A03E05 C13: Maximum retry count       L 2  V 2
TLV Choice [1]? 3
Deleted TLV: T x00A03E04 C12: VCC timeout period (sec)   L 4  V 600
```

**list**

Use this command to display the TLVs for this ELAN.

**Example: tlv list**

```
ELAN 'R&D Token Ring Elan' selected+ tlv list
Type: [x00A03E01] C7 : Control timeout (sec)
Length: 2 Value: 60
Type: [x00A03E05] C13: Maximum retry count
Length: 2 Value: 2
```

**Exit**

Use this command to return to the LECS ELANs Console environment.

**Syntax:** `exit`

**Example:** `exit`

### Security for LE Service Console Commands

The LES-LECS Security Interface Console environment is characterized by the LES-LECS interface+ prompt. From this environment, the LES-LECS interface can be created, deleted, or restarted. Counters associated with the LES-LECS interface can be reset or displayed. The LES-LECS Security Interface is the LE Services component responsible for multiplexing configuration requests from the LESs on the MSS Server to the LECS (which may or may not be on the MSS Server). The LES-LECS interface is a required component if any of the LES-BUSs are using the security features of the MSS Server.

Enter commands at the LES-LECS interface+ prompt. To access the prompt for monitoring, do the following:

```
+ network net#
ATM+ le-s
LE-Services Console
LE-SERVICES+ security
LES-LECS Security Interface
LES-LECS interface+
```

*Table 24-7. Security for LE Services Monitoring Commands Summary*

Command	Function
<b>? (Help)</b>	Lists the console commands or lists the actions associated with specific commands
<b>Create</b>	Creates the LES-LECS interface for the authentication of LE client joins.
<b>Delete</b>	Deletes the LES-LECS interface for the authentication of LE client joins.
<b>List</b>	Lists the LES-LECS interface's status and current configuration parameters.
<b>Restart</b>	Restarts a running LES-LECS interface.
<b>Statistics</b>	Clears or lists statistics of the LES-LECS interface.
<b>Exit</b>	Returns to the previous prompt

## Help

Use the **? (help)** command to list the commands that are available from the current prompt level. You also can enter a ? after a specific command name to list its options.

**Syntax:** ?

**Example:** ?

```
? (HELP)
CREATE
DELETE
LIST
RESTART
STATISTICS
EXIT
```

## Create

Use the **create** command to create the LES-LECS Interface for authentication of LE Client Joins. The LES-LECS Interface configuration must exist before it can be created (see “LES” on page 24-47). By default, when an Multiprotocol Switched Services (MSS) Server boots up, the LES-LECS Interface is created if it is configured and enabled. The **create** command allows the LES-LECS Interface to be created without restarting the entire router.

**Syntax:** `create`

**Example: create**

```
LES-LECS interface+ create
LECS interface created on device 0
```

## Delete

Use the **delete** command to stop an LES-LECS Interface and remove it from the active configuration. (The LES-LECS Interface definition remains in Static configuration.) If you issue the **delete** command and then want to start the LES-LECS Interface without restarting the Multiprotocol Switched Services (MSS) Server, issue the **create** command.

**Syntax:** `delete`

**Example: delete**

```
LES-LECS interface+ delete
LECS interface deleted
```

## List

Use the **list** command to list the status and current configuration parameters of the LES-LECS Interface.

**Syntax:** `list`

**Example: list**

```
LES-LECS interface+ list
Status of LES-LECS Security Interface
ATM Device Number:      0
State:                   Operating normally(110)
  Time of last state change:    00.23.44.26
  Elapsed time since last change: 00.01.10.70
Error Log:               no err(0)
ATM address:             3999999999999900009999010110005a68001201
UNI version:              UNI Version 3.0
Connected LECS:         4700790000000000000000000000a03e00000100(local)
VCC characteristics:
  Configuration direct VCC type:    Best Effort
  Configuration direct VCC PCR:     155000
```

Where:

*State*

Is the operational state of the LES-LECS Interface. Possible states are:

- Idle
- Initializing
- Activating ATM address
- Activated ATM address

	<ul style="list-style-type: none"><li>• Getting UNI version</li><li>• Got UNI version</li><li>• Getting list of LECSs</li><li>• Got list of LECSs</li><li>• Attempting to connect to LECS</li><li>• Failed to connect to LECS - will retry</li><li>• Operating normally</li><li>• Connection to LECS released - will retry</li><li>• ATM address deactivated</li><li>• ATM network down</li><li>• Down due to error</li><li>• State unknown!!!</li></ul>
<i>Time of last state change</i>	Is the system up time that the LES-LECS Interface entered its current state. The format is hours.minutes.seconds.hundredths
<i>Elapsed time since last change</i>	Is the amount of time since the last state change. The format is hours.minutes.seconds.hundredths
<i>Error Log</i>	Is the reason the LES-LECS Interface last went down. If the LES-LECS Interface has not been down since the last MSS Server restart, no err appears. An additional error code is contained within the parentheses.
<i>ATM Address</i>	Is the ATM address of the LES-LECS Interface.
<i>Connected LECS</i>	Is the ATM address used by the LES-LECS Interface to connect to the LECS. Following this ATM address is an indication of whether the LECS is local to this MSS Server or remote, that is, on another device.
<i>Configuration direct VCC type</i>	Indicates whether the LES-LECS Interface uses a best effort or reserved bandwidth VCC to the LECS.
<i>Configuration direct VCC PCR</i>	Indicates the peak cell rate of the configuration direct VCC to the LECS.
<i>VCC characteristics</i>	If VCC type is Reserved Bandwidth, the Sustained Cell Rate of the VCC in Kbps is shown.

## Restart

Use the **restart** command to restart a running LES-LECS Interface.

**Syntax:** `_restart`

**Example:** `restart`

```
LES-LECS interface+ restart
LECS interface restarted on device 0
```

## Statistics

Use the **statistics** command to clear or list all LES-LECS Interface statistics.

**Syntax:** statistics clear

list

**clear** Sets all LES-LECS Interface statistics to zero.

**Example: statistics clear**

```
LES-LECS interface+ statistics clear
LECS interface statistics cleared
```

**list** Shows all statistics for the LES-LECS Interface.

**Example: statistics list**

```
LES-LECS interface+ statistics list
Statistics of LES-LECS Security Interface
# queries to local LECS:          3
# frames transmitted:            0
# frames received:               0
# discarded frames:              0
# VCCs released by LECS/network: 0
# failed VCC setup attempts:     0
```

Where:

# VCCs released by LECS/network

Is the number of times Security VCC from the LES-LECS Interface to the LECS has been released. Releases due to LES-LECS Interface errors or changes in the LES-LECS Interface administrative status are not counted.

# failed VCC setup attempts

Is the number of Security VCC call setup requests made by the LES-LECS Interface that failed for any reason.

## Exit

Use the **exit** command to return to the LES console+ prompt.

**Syntax:** exit





---

## List of Abbreviations

<b>AAL</b>	ATM Adaptation Layer	<b>BR</b>	bridging/routing
<b>AAL-5</b>	ATM Adaptation Layer 5	<b>BRS</b>	bandwidth reservation
<b>AARP</b>	AppleTalk Address Resolution Protocol	<b>BSD</b>	Berkeley software distribution
<b>ABR</b>	area border router	<b>BTP</b>	BOOTP relay agent
<b>ack</b>	acknowledgement	<b>BTU</b>	basic transmission unit
<b>AIX</b>	Advanced Interactive Executive	<b>BUS</b>	Broadcast and Unknown Server
<b>AMA</b>	arbitrary MAC addressing	<b>CAM</b>	content-addressable memory
<b>AMP</b>	active monitor present	<b>CCITT</b>	Consultative Committee on International Telegraph and Telephone
<b>ANSI</b>	American National Standards Institute	<b>CD</b>	collision detection
<b>AP2</b>	AppleTalk Phase 2	<b>CGWCON</b>	Gateway Console
<b>APPN</b>	Advanced Peer-to-Peer Networking	<b>CIDR</b>	Classless Inter-Domain Routing
<b>ARE</b>	all-routes explorer	<b>CIP</b>	Classical IP
<b>ARI/FCI</b>	address recognized indicator/frame copied indicator	<b>CIPC</b>	Classical IP Client
<b>ARP</b>	Address Resolution Protocol	<b>CIR</b>	committed information rate
<b>AS</b>	autonomous system	<b>CLNP</b>	Connectionless-Mode Network Protocol
<b>ASBR</b>	autonomous system boundary router	<b>CPU</b>	central processing unit
<b>ASCII</b>	American National Standard Code for Information Interchange	<b>CRC</b>	cyclic redundancy check
<b>ASN.1</b>	abstract syntax notation 1	<b>CRS</b>	configuration report server
<b>ASRT</b>	adaptive source routing transparent	<b>CTS</b>	clear to send
<b>ASYNC</b>	asynchronous	<b>CUD</b>	call user data
<b>ATCP</b>	AppleTalk Control Protocol	<b>DAF</b>	destination address filtering
<b>ATM</b>	Asynchronous Transfer Mode	<b>DB</b>	database
<b>ATMARP</b>	ARP in Classical IP	<b>DBsum</b>	database summary
<b>ATP</b>	AppleTalk Transaction Protocol	<b>DCD</b>	data channel received line signal detector
<b>AUI</b>	attachment unit interface	<b>DCE</b>	data circuit-terminating equipment
<b>ayt</b>	are you there	<b>DDLC</b>	dual data-link controller
<b>BAN</b>	Boundary Access Node	<b>DDN</b>	Defense Data Network
<b>BBCM</b>	Bridging Broadcast Manager	<b>DDP</b>	Datagram Delivery Protocol
<b>BCM</b>	BroadCast Manager	<b>DDT</b>	Dynamic Debugging Tool
<b>BECN</b>	backward explicit congestion notification	<b>DHCP</b>	Dynamic Host Configuration Protocol
<b>BGP</b>	Border Gateway Protocol	<b>dir</b>	directly connected
<b>BGP</b>	Border Growth Protocol	<b>DL</b>	data link
<b>BNC</b>	bayonet Niell-Concelman	<b>DLC</b>	data link control
<b>BNCP</b>	Bridging Network Control Protocol	<b>DLCI</b>	data link connection identifier
<b>BOOTP</b>	BOOT protocol	<b>DLS</b>	data link switching
<b>BPDU</b>	bridge protocol data unit	<b>DLSw</b>	data link switching
<b>bps</b>	bits per second	<b>DMA</b>	direct memory access
		<b>DNA</b>	Digital Network Architecture

<b>DNCP</b>	DECnet Protocol Control Protocol	<b>HTF</b>	host table format
<b>DNIC</b>	Data Network Identifier Code	<b>IBD</b>	Integrated Boot Device
<b>DoD</b>	Department of Defense	<b>ICMP</b>	Internet Control Message Protocol
<b>DOS</b>	Disk Operating System	<b>ICP</b>	Internet Control Protocol
<b>DR</b>	designated router	<b>ID</b>	identification
<b>DRAM</b>	Dynamic Random Access Memory	<b>IDP</b>	Initial Domain Part
<b>DSAP</b>	destination service access point	<b>IDP</b>	Internet Datagram Protocol
<b>DSE</b>	data switching equipment	<b>IEEE</b>	Institute of Electrical and Electronics Engineers
<b>DSE</b>	data switching exchange	<b>IETF</b>	Internet Engineering Task Force
<b>DSR</b>	data set ready	<b>Ifc#</b>	interface number
<b>DSU</b>	data service unit	<b>IGP</b>	interior gateway protocol
<b>DTE</b>	data terminal equipment	<b>ILMI</b>	Interim Local Management Interface
<b>DTR</b>	data terminal ready	<b>InARP</b>	Inverse Address Resolution Protocol
<b>Dtype</b>	destination type	<b>IP</b>	Internet Protocol
<b>DVMRP</b>	Distance Vector Multicast Routing Protocol	<b>IPCP</b>	IP Control Protocol
<b>E1</b>	2.048 Mbps transmission rate	<b>IPPN</b>	IP Protocol Network
<b>EDEL</b>	end delimiter	<b>IPX</b>	Internetwork Packet Exchange
<b>EDI</b>	error detected indicator	<b>IPXCP</b>	IPX Control Protocol
<b>EGP</b>	Exterior Gateway Protocol	<b>ISDN</b>	integrated services digital network
<b>EIA</b>	Electronics Industries Association	<b>ISO</b>	International Organization for Standardization
<b>ELAN</b>	Emulated Local Area Network	<b>Kbps</b>	kilobits per second
<b>ELAP</b>	EtherTalk Link Access Protocol	<b>LAN</b>	local area network
<b>ELS</b>	Event Logging System	<b>LAPB</b>	link access protocol-balanced
<b>ESI</b>	End System Identifier	<b>LAT</b>	local area transport
<b>EST</b>	Eastern Standard Time	<b>LCP</b>	Link Control Protocol
<b>Eth</b>	Ethernet	<b>LE</b>	LAN Emulation
<b>fa-ga</b>	functional address-group address	<b>LEC</b>	LAN Emulation Client
<b>FCS</b>	frame check sequence	<b>LED</b>	light-emitting diode
<b>FECN</b>	forward explicit congestion notification	<b>LECS</b>	LAN Emulation Configuration Server
<b>FIFO</b>	first in, first out	<b>LES</b>	LAN Emulation Server
<b>FLT</b>	filter library	<b>LES-BUS</b>	LAN Emulation Server - Broadcast and Unknown Server
<b>FR</b>	Frame Relay	<b>LF</b>	largest frame; line feed
<b>FRL</b>	Frame Relay	<b>LIS</b>	Logical IP subnet
<b>FTP</b>	File Transfer Protocol	<b>LLC</b>	logical link control
<b>GMT</b>	Greenwich Mean Time	<b>LLC2</b>	logical link control 2
<b>GOSIP</b>	Government Open Systems Interconnection Profile	<b>LMI</b>	local management interface
<b>GTE</b>	General Telephone Company	<b>LRM</b>	LAN reporting mechanism
<b>GWCON</b>	Gateway Console	<b>LS</b>	link state
<b>HDLC</b>	high-level data link control	<b>LSA</b>	link state advertisement
<b>HEX</b>	hexadecimal		
<b>HST</b>	TCP/IP host services		

<b>LSB</b>	least significant bit	<b>OSPF</b>	Open Shortest Path First
<b>LSreq</b>	link state request	<b>OUI</b>	organization unique identifier
<b>LSrxl</b>	link state retransmission list	<b>PC</b>	personal computer
<b>LU</b>	logical unit	<b>PDN</b>	public data network
<b>MAC</b>	medium access control	<b>PING</b>	Packet internet groper
<b>Mb</b>	megabit	<b>PDU</b>	protocol data unit
<b>MB</b>	megabyte	<b>PID</b>	process identification
<b>Mbps</b>	megabits per second	<b>P-P</b>	Point-to-Point
<b>MBps</b>	megabytes per second	<b>PPP</b>	Point-to-Point Protocol
<b>MC</b>	multicast	<b>PROM</b>	programmable read-only memory
<b>MCF</b>	MAC filtering	<b>PU</b>	physical unit
<b>MIB</b>	Management Information Base	<b>PVC</b>	permanent virtual circuit
<b>MIB II</b>	Management Information Base II	<b>QoS</b>	Quality of Service
<b>MILNET</b>	military network	<b>RAM</b>	random access memory
<b>MOS</b>	Micro Operating System	<b>RD</b>	route descriptor
<b>MOSDDT</b>	Micro Operating System Dynamic Debugging Tool	<b>REM</b>	ring error monitor
<b>MOSPF</b>	Open Shortest Path First with multicast extensions	<b>REV</b>	receive
<b>MSB</b>	most significant bit	<b>RFC</b>	Request for Comments
<b>MSDU</b>	MAC service data unit	<b>RI</b>	ring indicator; routing information
<b>MSS</b>	Multiprotocol Switched Services	<b>RIF</b>	routing information field
<b>MTU</b>	maximum transmission unit	<b>RII</b>	routing information indicator
<b>nak</b>	not acknowledged	<b>RIP</b>	Routing Information Protocol
<b>NBP</b>	Name Binding Protocol	<b>RISC</b>	reduced instruction-set computer
<b>NBR</b>	neighbor	<b>RNR</b>	receive not ready
<b>NCP</b>	Network Control Protocol	<b>ROM</b>	read-only memory
<b>NCP</b>	Network Core Protocol	<b>ROpcon</b>	Remote Operator Console
<b>NetBIOS</b>	Network Basic Input/Output System	<b>RPS</b>	ring parameter server
<b>NHRP</b>	Next Hop Resolution Protocol	<b>RTMP</b>	Routing Table Maintenance Protocol
<b>NIST</b>	National Institute of Standards and Technology	<b>RTP</b>	RouTing update Protocol
<b>NPDU</b>	Network Protocol Data Unit	<b>RTS</b>	request to send
<b>NRZ</b>	non-return-to-zero	<b>Rtype</b>	route type
<b>NRZI</b>	non-return-to-zero inverted	<b>rxmits</b>	retransmissions
<b>NSAP</b>	Network Service Access Point	<b>rxmt</b>	retransmit
<b>NSF</b>	National Science Foundation	<b>SAF</b>	source address filtering
<b>NSFNET</b>	National Science Foundation NETwork	<b>SAP</b>	service access point
<b>NVCNFG</b>	non-volatile configuration	<b>SAP</b>	Service Advertising Protocol
<b>OPCON</b>	Operator Console	<b>sdel</b>	start delimiter
<b>OSI</b>	open systems interconnection	<b>SDLC</b>	SDLC relay, synchronous data link control
<b>OSICP</b>	OSI Control Protocol	<b>SDU</b>	Service Data Unit
		<b>seqno</b>	sequence number
		<b>SGMP</b>	Simple Gateway Monitoring Protocol

<b>SL</b>	serial line	<b>TEI</b>	terminal point identifier
<b>SLIP</b>	Serial Line IP	<b>TFTP</b>	Trivial File Transfer Protocol
<b>SMP</b>	standby monitor present	<b>TKR</b>	token ring
<b>SMTP</b>	Simple Mail Transfer Protocol	<b>TLV</b>	Type/Length/Value
<b>SNA</b>	Systems Network Architecture	<b>TMO</b>	timeout
<b>SNAP</b>	Subnetwork Access Protocol SubNetwork Attachment Point	<b>TOS</b>	type of service
<b>SNMP</b>	Simple Network Management Protocol	<b>TSF</b>	transparent spanning frames
<b>SNPA</b>	subnetwork point of attachment	<b>TTL</b>	time to live
<b>SPF</b>	OSPF intra-area route	<b>TTY</b>	teletypewriter
<b>SPE1</b>	OSPF external route type 1	<b>TX</b>	transmit
<b>SPE2</b>	OSPF external route type 2	<b>UA</b>	unnumbered acknowledgment
<b>SPIA</b>	OSPF inter-area route type	<b>UDP</b>	User Datagram Protocol
<b>SPID</b>	service profile ID	<b>UI</b>	unnumbered information
<b>SPX</b>	Sequenced Packet Exchange	<b>UNI</b>	User-Network Interface
<b>SQE</b>	signal quality error	<b>UTP</b>	unshielded twisted pair
<b>SRAM</b>	static random access memory	<b>VCC</b>	Virtual Channel connection
<b>SRB</b>	source routing bridge	<b>VINES</b>	Virtual NEtworking System
<b>SRF</b>	specifically routed frame	<b>VIR</b>	variable information rate
<b>SRLY</b>	SDLC relay	<b>VL</b>	virtual link
<b>SRT</b>	source routing transparent	<b>VR</b>	virtual route
<b>SR-TB</b>	source routing-transparent bridge	<b>WAN</b>	wide area network
<b>STA</b>	static	<b>WRS</b>	WAN restoral
<b>STB</b>	spanning tree bridge	<b>X.25</b>	packet-switched networks
<b>STE</b>	spanning tree explorer	<b>X.251</b>	X.25 physical layer
<b>STP</b>	shielded twisted pair; spanning tree protocol	<b>X.252</b>	X.25 frame layer
<b>SVC</b>	switched virtual circuit	<b>X.253</b>	X.25 packet layer
<b>SVN</b>	Switched Virtual Networking	<b>XID</b>	exchange identification
<b>TB</b>	transparent bridge	<b>XNS</b>	Xerox Network Systems
<b>TCN</b>	topology change notification	<b>XSUM</b>	checksum
<b>TCP</b>	Transmission Control Protocol	<b>ZIP</b>	AppleTalk Zone Information Protocol
<b>TCP/IP</b>	Transmission Control Protocol/Internet Protocol	<b>ZIP2</b>	AppleTalk Zone Information Protocol 2
		<b>ZIT</b>	Zone Information Table

---

# Glossary

This glossary includes terms and definitions from:

- The *American National Standard Dictionary for Information Systems*, ANSI X3.172-1990, copyright 1990 by the American National Standards Institute (ANSI). Copies may be purchased from the American National Standards Institute, 11 West 42nd Street, New York, New York 10036. Definitions are identified by the symbol (A) after the definition.
- The ANSI/EIA Standard—440-A, *Fiber Optic Terminology*. Copies may be purchased from the Electronic Industries Association, 2001 Pennsylvania Avenue, N.W., Washington, DC 20006. Definitions are identified by the symbol (E) after the definition.
- The *Information Technology Vocabulary*, developed by Subcommittee 1, Joint Technical Committee 1, of the International Organization for Standardization and the International Electrotechnical Commission (ISO/IEC JTC1/SC1). Definitions of published parts of this vocabulary are identified by the symbol (I) after the definition; definitions taken from draft international standards, committee drafts, and working papers being developed by ISO/IEC JTC1/SC1 are identified by the symbol (T) after the definition, indicating that final agreement has not yet been reached among the participating National Bodies of SC1.
- The *IBM Dictionary of Computing*, New York: McGraw-Hill, 1994.
- Internet Request for Comments: 1208, *Glossary of Networking Terms*.
- Internet Request for Comments: 1392, *Internet Users' Glossary*.
- The *Object-Oriented Interface Design: IBM Common User Access Guidelines*, Carmel, Indiana: Que, 1992.

The following cross-references are used in this glossary:

**Contrast with:** This refers to a term that has an opposed or substantively different meaning.

**Synonym for:** This indicates that the term has the same meaning as a preferred term, which is defined in its proper place in the glossary.

**Synonymous with:** This is a backward reference from a defined term to all other terms that have the same meaning.

**See:** This refers the reader to multiple-word terms that have the same last word.

**See also:** This refers the reader to terms that have a related, but not synonymous, meaning.

## A

**AAL.** ATM Adaptation Layer, the layer that adapts user data to/from the ATM network by adding/removing headers and segmenting/reassembling the data into/from cells.

**AAL-5.** ATM Adaptation Layer 5, one of several standard AALs. AAL-5 was designed for data communications, and is used by LAN Emulation and Classical IP.

**abstract syntax.** A data specification that includes all distinctions that are needed in data transmissions, but that omits (abstracts) other details such as those that depend on specific computer architectures. See also *abstract syntax notation 1 (ASN.1)* and *basic encoding rules (BER)*.

**abstract syntax notation 1 (ASN.1).** The Open Systems Interconnection (OSI) method for abstract syntax specified in the following standards:

- ITU-T Recommendation X.208 (1988) | ISO/IEC 8824: 1990
- ITU-T Recommendation X.680 (1994) | ISO/IEC 8824-1: 1994

See also *basic encoding rules (BER)*.

**ACCESS.** In the Simple Network Management Protocol (SNMP), the clause in a Management Information Base (MIB) module that defines the minimum level of support that a managed node provides for an object.

**acknowledgment.** (1) The transmission, by a receiver, of acknowledge characters as an affirmative response to a sender. (T) (2) An indication that an item sent was received.

**active monitor.** In a token-ring network, a function performed at any one time by one ring station that initiates the transmission of tokens and provides token error recovery facilities. Any active adapter on the ring has the ability to provide the active monitor function if the current active monitor fails.

**address.** In data communication, the unique code assigned to each device, workstation, or user connected to a network.

**address mapping table (AMT).** A table, maintained within the AppleTalk router, that provides a current mapping of node addresses to hardware addresses.

**address mask.** For internet subnetting, a 32-bit mask used to identify the subnetwork address bits in the host portion of an IP address. Synonymous with *subnet mask* and *subnetwork mask*.

**address resolution.** (1) A method for mapping network-layer addresses to media-specific addresses. (2) See also *Address Resolution Protocol (ARP)* and *AppleTalk Address Resolution Protocol (AARP)*.

**Address Resolution Protocol (ARP).** (1) In the Internet suite of protocols, the protocol that dynamically maps an IP address to an address used by a supporting metropolitan or local area network such as Ethernet or token-ring. (2) See also *Reverse Address Resolution Protocol (RARP)*.

**addressing.** In data communication, the way in which a station selects the station to which it is to send data.

**adjacent nodes.** Two nodes connected together by at least one path that connects no other node. (T)

**Administrative Domain.** A collection of hosts and routers, and the interconnecting networks, managed by a single administrative authority.

**Advanced Peer-to-Peer Networking (APPN).** An extension to SNA featuring (a) greater distributed network control that avoids critical hierarchical dependencies, thereby isolating the effects of single points of failure; (b) dynamic exchange of network topology information to foster ease of connection, reconfiguration, and adaptive route selection; (c) dynamic definition of network resources; and (d) automated resource registration and directory lookup. APPN extends the LU 6.2 peer orientation for end-user services to network control and supports multiple LU types, including LU 2, LU 3, and LU 6.2.

**Advanced Peer-to-Peer Networking (APPN) end node.** A node that provides a broad range of end-user services and supports sessions between its local control point (CP) and the CP in an adjacent network node. It uses these sessions to dynamically register its resources with the adjacent CP (its network node server), to send and receive directory search requests, and to obtain management services. An APPN end node can also attach to a subarea network as a peripheral node or to other end nodes.

**Advanced Peer-to-Peer Networking (APPN) network.** A collection of interconnected network nodes and their client end nodes.

**Advanced Peer-to-Peer Networking (APPN) network node.** A node that offers a broad range of end-user services and that can provide the following:

- Distributed directory services, including registration of its domain resources to a central directory server
- Topology database exchanges with other APPN network nodes, enabling network nodes throughout the network to select optimal routes for LU-LU sessions based on requested classes of service
- Session services for its local LUs and client end nodes
- Intermediate routing services within an APPN network

**Advanced Peer-to-Peer Networking (APPN) node.** An APPN network node or an APPN end node.

**alert.** A message sent to a management services focal point in a network to identify a problem or an impending problem.

**all-stations address.** In communications, synonym for *broadcast address*.

**American National Standards Institute (ANSI).** An organization consisting of producers, consumers, and general interest groups, that establishes the procedures by which accredited organizations create and maintain voluntary industry standards in the United States. (A)

**analog.** (1) Pertaining to data consisting of continuously variable physical quantities. (A)  
(2) Contrast with *digital*.

**AppleTalk.** A network protocol developed by Apple Computer, Inc. This protocol is used to interconnect network devices, which can be a mixture of Apple and non-Apple products.

**AppleTalk Address Resolution Protocol (AARP).** In AppleTalk networks, a protocol that (a) translates AppleTalk node addresses into hardware addresses and (b) reconciles addressing discrepancies in networks that support more than one set of protocols.

**AppleTalk Transaction Protocol (ATP).** In AppleTalk networks, a protocol that provides client/server request and response functions for hosts accessing the Zone Information Protocol (ZIP) for zone information.

**APPN network.** See *Advanced Peer-to-Peer Networking (APPN) network*.

**APPN network node.** See *Advanced Peer-to-Peer Networking (APPN) network node*.

**arbitrary MAC addressing (AMA).** In DECnet architecture, an addressing scheme used by DECnet

Phase IV-Prime that supports universally administered addresses and locally administered addresses.

**area.** In Internet and DECnet routing protocols, a subset of a network or gateway grouped together by definition of the network administrator. Each area is self-contained; knowledge of an area's topology remains hidden from other areas.

**asynchronous (ASYNC).** Pertaining to two or more processes that do not depend upon the occurrence of specific events such as common timing signals. (T)

**ATM.** Asynchronous Transfer Mode, a connection-oriented, high-speed networking technology based on cell switching.

**ATMARP.** ARP in Classical IP.

**attachment unit interface (AUI).** In a local area network, the interface between the medium attachment unit and the data terminal equipment within a data station. (I) (A)

**authentication failure.** In the Simple Network Management Protocol (SNMP), a trap that may be generated by an authentication entity when a requesting client is not a member of the SNMP community.

**autonomous system.** In TCP/IP, a group of networks and routers under one administrative authority. These networks and routers cooperate closely to propagate network reachability (and routing) information among themselves using an interior gateway protocol of their choice.

**autonomous system number.** In TCP/IP, a number assigned to an autonomous system by the same central authority that also assigns IP addresses. The autonomous system number makes it possible for automated routing algorithms to distinguish autonomous systems.

## B

**BCM.** BroadCast Manager, an IBM extension to LAN Emulation designed to limit the effects of broadcast frames.

**backbone.** (1) In a local area network multiple-bridge ring configuration, a high-speed link to which the rings are connected by means of bridges or routers. A backbone may be configured as a bus or as a ring. (2) In a wide area network, a high-speed link to which nodes or data switching exchanges (DSEs) are connected.

**backbone network.** A central network to which smaller networks, normally of lower speed, connect. The backbone network usually has a much higher

capacity than the networks it helps interconnect or is a wide-area network (WAN) such as a public packet-switched datagram network.

**backbone router.** (1) A router used to transmit data between areas. (2) One in a series of routers that is used to interconnect networks into a larger internet.

**Bandwidth.** The bandwidth of an optical link designates the information-carrying capacity of the link and is related to the maximum bit rate that a fiber link can support.

**basic transmission unit (BTU).** In SNA, the unit of data and control information passed between path control components. A BTU can consist of one or more path information units (PIUs).

**bootstrap.** (1) A sequence of instructions whose execution causes additional instructions to be loaded and executed until the complete computer program is in storage. (T) (2) A technique or device designed to bring itself into a desired state by means of its own action, for example, a machine routine whose first few instructions are sufficient to bring the rest of itself into the computer from an input device. (A)

**baud.** In asynchronous transmission, the unit of modulation rate corresponding to one unit interval per second; that is, if the duration of the unit interval is 20 milliseconds, the modulation rate is 50 baud. (A)

**Border Gateway Protocol (BGP).** An Internet Protocol (IP) routing protocol used between domains and autonomous systems. Contrast with *Exterior Gateway Protocol (EGP)*.

**border router.** In Internet communications, a router, positioned at the edge of an autonomous system, that communicates with a router that is positioned at the edge of a different autonomous system.

**bridge.** A functional unit that interconnects multiple LANs (locally or remotely) that use the same logical link control protocol but that can use different medium access control protocols. A bridge forwards a frame to another bridge based on the medium access control (MAC) address.

**bridge identifier.** An 8-byte field, used in a spanning tree protocol, composed of the MAC address of the port with the lowest port identifier and a user-defined value.

**bridging.** In LANs, the forwarding of a frame from one LAN segment to another. The destination is specified by the medium access control (MAC) sublayer address encoded in the destination address field of the frame header.

**broadcast.** (1) Transmission of the same data to all destinations. (T) (2) Simultaneous transmission of data

to more than one destination. (3) Contrast with *multicast*.

**broadcast address.** In communications, a station address (eight 1's) reserved as an address common to all stations on a link. Synonymous with *all-stations address*.

**BUS.** Broadcast and Unknown Server, a LAN Emulation Service component responsible for the delivery of multicast and unknown unicast frames.

## C

**cache.** (1) A special-purpose buffer storage, smaller and faster than main storage, used to hold a copy of instructions and data obtained from main storage and likely to be needed next by the processor. (T) (2) A buffer storage that contains frequently accessed instructions and data; it is used to reduce access time. (3) An optional part of the directory database in network nodes where frequently used directory information may be stored to speed directory searches. (4) To place, hide, or store in a cache.

**call request packet.** (1) A call supervision packet that a data terminal equipment (DTE) transmits to ask that a connection for a call be established throughout the network. (2) In X.25 communications, a call supervision packet transmitted by a DTE to ask for a call establishment through the network.

**canonical address.** In LANs, the IEEE 802.1 format for the transmission of medium access control (MAC) addresses for token-ring and Ethernet adapters. In canonical format, the least significant (rightmost) bit of each address byte is transmitted first. Contrast with *noncanonical address*.

**carrier.** An electric or electromagnetic wave or pulse train that may be varied by a signal bearing information to be transmitted over a communication system. (T)

**carrier detect.** Synonym for *received line signal detector (RLSD)*.

**carrier sense.** In a local area network, an ongoing activity of a data station to detect whether another station is transmitting. (T)

**carrier sense multiple access with collision detection (CSMA/CD).** A protocol that requires carrier sense and in which a transmitting data station that detects another signal while transmitting, stops sending, sends a jam signal, and then waits for a variable time before trying again. (T) (A)

**channel.** (1) A path along which signals can be sent, for example, data channel, output channel. (A) (2) A

functional unit, controlled by the processor, that handles the transfer of data between processor storage and local peripheral equipment.

**channel service unit (CSU).** A unit that provides the interface to a digital network. The CSU provides line conditioning (or equalization) functions, which keep the signal's performance consistent across the channel bandwidth; signal reshaping, which constitutes the binary pulse stream; and loopback testing, which includes the transmission of test signals between the CSU and the network carrier's office channel unit. See also *data service unit (DSU)*.

**checksum.** (1) The sum of a group of data associated with the group and used for checking purposes. (T) (2) In error detection, a function of all bits in a block. If the written and calculated sums do not agree, an error is indicated. (3) On a diskette, data written in a sector for error detection purposes; a calculated checksum that does not match the checksum of data written in the sector indicates a bad sector. The data are either numeric or other character strings regarded as numeric for the purpose of calculating the checksum.

**CIP.** Classical IP.

**CIPC.** Classical IP Client.

**Classical IP.** An IETF standard for ATM-attached hosts to communicate using IP over ATM.

**Classical IP Client.** A Classical IP component that represents users of the Logical IP Subnet.

**circuit switching.** (1) A process that, on demand, connects two or more data terminal equipment (DTEs) and permits the exclusive use of a data circuit between them until the connection is released. (I) (A) (2) Synonymous with *line switching*.

**class A network.** In Internet communications, a network in which the high-order (most significant) bit of the IP address is set to 0 and the host ID occupies the three low-order octets.

**class B network.** In Internet communications, a network in which the two high-order (most significant and next-to-most significant) bits of the IP address are set to 1 and 0, respectively, and the host ID occupies the two low-order octets.

**class of service (COS).** A set of characteristics (such as route security, transmission priority, and bandwidth) used to construct a route between session partners. The class of service is derived from a mode name specified by the initiator of a session.

**client.** (1) A functional unit that receives shared services from a server. (T) (2) A user.



**client/server.** In communications, the model of interaction in distributed data processing in which a program at one site sends a request to a program at another site and awaits a response. The requesting program is called a client; the answering program is called a server.

**clocking.** (1) In binary synchronous communication, the use of clock pulses to control synchronization of data and control characters. (2) A method of controlling the number of data bits sent on a telecommunication line in a given time.

**collision.** An unwanted condition that results from concurrent transmissions on a channel. (T)

**collision detection.** In carrier sense multiple access with collision detection (CSMA/CD), a signal indicating that two or more stations are transmitting simultaneously.

**Committed information rate.** The maximum amount of data in bits that the network agrees to deliver.

**community.** In the Simple Network Management Protocol (SNMP), an administrative relationship between entities.

**community name.** In the Simple Network Management Protocol (SNMP), a string of octets identifying a community.

**compression.** (1) The process of eliminating gaps, empty fields, redundancies, and unnecessary data to shorten the length of records or blocks. (2) Any encoding to reduce the number of bits used to represent a given message or record.

**configuration.** (1) The manner in which the hardware and software of an information processing system are organized and interconnected. (T) (2) The devices and programs that make up a system, subsystem, or network.

**configuration file.** A file that specifies the characteristics of a system device or network.

**configuration parameter.** A variable in a configuration definition, the values of which can characterize the relationship of a product to other products in the same network or can define characteristics of the product itself.

**configuration report server (CRS).** In the IBM Token-Ring Network Bridge Program, the server that accepts commands from the LAN Network Manager (LNM) to get station information, set station parameters, and remove stations on its ring. This server also collects and forwards configuration reports generated by stations on its ring. The configuration reports include

the new active monitor reports and the nearest active upstream neighbor (NAUN) reports.

**congestion.** See *network congestion*.

**control point (CP).** (1) A component of an APPN or LEN node that manages the resources of that node. In an APPN node, the CP is capable of engaging in CP-CP sessions with other APPN nodes. In an APPN network node, the CP also provides services to adjacent end nodes in the APPN network. (2) A component of a node that manages resources of that node and optionally provides services to other nodes in the network. Examples are a system services control point (SSCP) in a type 5 subarea node, a network node control point (NNCP) in an APPN network node, and an end node control point (ENCP) in an APPN or LEN end node. An SSCP and an NNCP can provide services to other nodes.

**control point management services (CPMS).** A component of a control point, consisting of management services function sets, that provides facilities to assist in performing problem management, performance and accounting management, change management, and configuration management. Capabilities provided by the CPMS include sending requests to physical unit management services (PUMS) to test system resources, collecting statistical information (for example, error and performance data) from PUMS about the system resources, and analyzing and presenting test results and statistical information collected about the system resources. Analysis and presentation responsibilities for problem determination and performance monitoring can be distributed among multiple CPMSs.

**control point management services unit (CP-MSU).** The message unit that contains management services data and flows between management services function sets. This message unit is in general data stream (GDS) format. See also *management services unit (MSU)* and *network management vector transport (NMVT)*.

## D

**D-bit.** Delivery-confirmation bit. In X.25 communications, the bit in a data packet or call-request packet that is set to 1 if end-to-end acknowledgment (delivery confirmation) is required from the recipient.

**daemon.** A program that runs unattended to perform a standard service. Some daemons are triggered automatically to perform their task; others operate periodically.

**data carrier detect (DCD).** Synonym for *received line signal detector (RLSD)*.

**data circuit.** (1) A pair of associated transmit and receive channels that provide a means of two-way data communication. (I) (2) In SNA, synonym for *link connection*. (3) See also *physical circuit* and *virtual circuit*.

**Notes:**

1. Between data switching exchanges, the data circuit may include data circuit-terminating equipment (DCE), depending on the type of interface used at the data switching exchange.
2. Between a data station and a data switching exchange or data concentrator, the data circuit includes the data circuit-terminating equipment at the data station end, and may include equipment similar to a DCE at the data switching exchange or data concentrator location.

**data circuit-terminating equipment (DCE).** In a data station, the equipment that provides the signal conversion and coding between the data terminal equipment (DTE) and the line. (I)

**Notes:**

1. The DCE may be separate equipment or an integral part of the DTE or of the intermediate equipment.
2. A DCE may perform other functions that are usually performed at the network end of the line.

**data link connection identifier (DLCI).** The numeric identifier of a frame-relay subport or PVC segment in a frame-relay network. Each subport in a single frame-relay port has a unique DLCI. The following table, excerpted from the American National Standards Institute (ANSI) Standard T1.618 and the International Telegraph and Telephone Consultative Committee (ITU-T/CCITT) Standard Q.922, indicates the functions associated with certain DLCI values:

DLCI Values	Function
0	in-channel signaling
1–15	reserved
16–991	assigned using frame-relay connection procedures
992–1007	layer 2 management of frame-relay bearer service
1008–1022	reserved
1023	in-channel layer management

**data link control (DLC).** A set of rules used by nodes on a data link (such as an SDLC link or a token ring) to accomplish an orderly exchange of information.

**data link control (DLC) layer.** In SNA, the layer that consists of the link stations that schedule data transfer over a link between two nodes and perform error control for the link. Examples of data link control are SDLC for

serial-by-bit link connection and data link control for the System/370 channel.

**Note:** The DLC layer is usually independent of the physical transport mechanism and ensures the integrity of data that reaches the higher layers.

**data link layer.** In the Open Systems Interconnection reference model, the layer that provides services to transfer data between entities in the network layer over a communication link. The data link layer detects and possibly corrects errors that may occur in the physical layer. (T)

**data link level.** (1) In the hierarchical structure of a data station, the conceptual level of control or processing logic between high level logic and the data link that maintains control of the data link. The data link level performs such functions as inserting transmit bits and deleting receive bits; interpreting address and control fields; generating, transmitting, and interpreting commands and responses; and computing and interpreting frame check sequences. See also *packet level* and *physical level*. (2) In X.25 communications, synonym for *frame level*.

**data link switching (DLSw).** A method of transporting network protocols that use IEEE 802.2 logical link control (LLC) type 2. SNA and NetBIOS are examples of protocols that use LLC type 2. See also *encapsulation* and *spoofing*.

**data packet.** In X.25 communications, a packet used for the transmission of user data on a virtual circuit at the DTE/DCE interface.

**data service unit (DSU).** A device that provides a digital data service interface directly to the data terminal equipment. The DSU provides loop equalization, remote and local testing capabilities, and a standard EIA/CCITT interface.

**data set ready (DSR).** Synonym for *DCE ready*.

**data switching exchange (DSE).** The equipment installed at a single location to provide switching functions, such as circuit switching, message switching, and packet switching. (I)

**data terminal equipment (DTE).** That part of a data station that serves as a data source, data sink, or both. (I) (A)

**data terminal ready (DTR).** A signal to the modem used with the EIA 232 protocol.

**data transfer rate.** The average number of bits, characters, or blocks per unit time passing between corresponding equipment in a data transmission system. (I)

**Notes:**

1. The rate is expressed in bits, characters, or blocks per second, minute, or hour.
2. Corresponding equipment should be indicated; for example, modems, intermediate equipment, or source and sink.

**datagram.** (1) In packet switching, a self-contained packet, independent of other packets, that carries information sufficient for routing from the originating data terminal equipment (DTE) to the destination DTE without relying on earlier exchanges between the DTEs and the network. (I) (2) In TCP/IP, the basic unit of information passed across the Internet environment. A datagram contains a source and destination address along with the data. An Internet Protocol (IP) datagram consists of an IP header followed by the transport layer data. (3) See also *packet* and *segment*.

**Datagram Delivery Protocol (DDP).** In AppleTalk networks, a protocol that provides network connectivity by means of connectionless socket-to-socket delivery service on the internet layer.

**DCE ready.** In the EIA 232 standard, a signal that indicates to the data terminal equipment (DTE) that the local data circuit-terminating equipment (DCE) is connected to the communication channel and is ready to send data. Synonymous with *data set ready (DSR)*.

**DECnet.** A network architecture that defines the operation of a family of software modules, databases, and hardware components typically used to tie Digital Equipment Corporation systems together for resource sharing, distributed computation, or remote system configuration. DECnet network implementations follow the Digital Network Architecture (DNA) model.

**default.** Pertaining to an attribute, condition, value, or option that is assumed when none is explicitly specified. (I)

**designated router.** A router that informs end nodes of the existence and identity of other routers. The selection of the designated router is based upon the router with the highest priority. When several routers share the highest priority, the router with the highest station address is selected.

**destination node.** The node to which a request or data is sent.

**destination port.** The 8-port asynchronous adapter that serves as a connection point with a serial service.

**destination service access point (DSAP).** In SNA and TCP/IP, a logical address that allows a system to route data from a remote device to the appropriate

communications support. Contrast with *source service access point (SSAP)*.

**device.** A mechanical, electrical, or electronic contrivance with a specific purpose.

**digital.** (1) Pertaining to data that consist of digits. (T) (2) Pertaining to data in the form of digits. (A) (3) Contrast with *analog*.

**Digital Network Architecture (DNA).** The model for all DECnet hardware and software implementations.

**direct memory access (DMA).** The system facility that allows a device on the Micro Channel bus to get direct access to the system or bus memory without the intervention of the system processor.

**directory.** A table of identifiers and references to the corresponding items of data. (I) (A)

**directory service (DS).** An application service element that translates the symbolic names used by application processes into the complete network addresses used in an OSI environment. (T)

**directory services (DS).** A control point component of an APPN node that maintains knowledge of the location of network resources.

**disable.** To make nonfunctional.

**disabled.** (1) Pertaining to a state of a processing unit that prevents the occurrence of certain types of interruptions. (2) Pertaining to the state in which a transmission control unit or audio response unit cannot accept incoming calls on a line.

**domain.** (1) That part of a computer network in which the data processing resources are under common control. (T) (2) In Open Systems Interconnection (OSI), a part of a distributed system or a set of managed objects to which a common policy applies. (3) See *Administrative Domain* and *domain name*.

**domain name.** In the Internet suite of protocols, a name of a host system. A domain name consists of a sequence of subnames separated by a delimiter character. For example, if the fully qualified domain name (FQDN) of a host system is `ralvm7.vnet.ibm.com`, each of the following is a domain name:

- `ralvm7.vnet.ibm.com`
- `vnet.ibm.com`
- `ibm.com`

**domain name server.** In the Internet suite of protocols, a server program that supplies name-to-address translation by mapping domain names to IP addresses. Synonymous with *name server*.

**Domain Name System (DNS).** In the Internet suite of protocols, the distributed database system used to map domain names to IP addresses.

**dotted decimal notation.** The syntactical representation for a 32-bit integer that consists of four 8-bit numbers written in base 10 with periods (dots) separating them. It is used to represent IP addresses.

**dump.** (1) Data that has been dumped. (T) (2) To copy the contents of all or part of virtual storage for the purpose of collecting error information.

**dynamic reconfiguration (DR).** The process of changing the network configuration (peripheral PUs and LUs) without regenerating complete configuration tables or deactivating the affected major node.

**Dynamic Routing.** Routing using learned routes rather than routes statically configured at initialization.

## E

**echo.** In data communication, a reflected signal on a communications channel. For example, on a communications terminal, each signal is displayed twice, once when entered at the local terminal and again when returned over the communications link. This allows the signals to be checked for accuracy.

**EIA 232.** In data communication, a specification of the Electronic Industries Association (EIA) that defines the interface between data terminal equipment (DTE) and data circuit-terminating equipment (DCE), using serial binary data interchange.

**ELAN.** Emulated Local Area Network, a LAN segment implemented with ATM technology.

**Electronic Industries Association (EIA).** An organization of electronics manufacturers that advances the technological growth of the industry, represents the views of its members, and develops industry standards.

**encapsulation.** (1) In communications, a technique used by layered protocols by which a layer adds control information to the protocol data unit (PDU) from the layer it supports. In this respect, the layer encapsulates the data from the supported layer. In the Internet suite of protocols, for example, a packet would contain control information from the physical layer, followed by control information from the network layer, followed by the application protocol data. (2) See also *data link switching*.

**encode.** To convert data by the use of a code in such a manner that reversion to the original form is possible. (T)

**end node (EN).** (1) See *Advanced Peer-to-Peer Networking (APPN) end node* and *low-entry networking (LEN) end node*. (2) In communications, a node that is frequently attached to a single data link and cannot perform intermediate routing functions.

**entry point (EP).** In SNA, a type 2.0, type 2.1, type 4, or type 5 node that provides distributed network management support. It sends network management data about itself and the resources it controls to a focal point for centralized processing, and it receives and executes focal-point initiated commands to manage and control its resources.

**ESI.** End System Identifier, a 6-byte component of an ATM address.

**Ethernet.** A 10-Mbps baseband local area network that allows multiple stations to access the transmission medium at will without prior coordination, avoids contention by using carrier sense and deference, and resolves contention by using collision detection and delayed retransmission. Ethernet uses carrier sense multiple access with collision detection (CSMA/CD).

**exception.** An abnormal condition such as an I/O error encountered in processing a data set or a file.

**exception response (ER).** In SNA, a protocol requested in the form-of-response-requested field of a request header that directs the receiver to return a response only if the request is unacceptable as received or cannot be processed; that is, a negative response, but not a positive response, can be returned. Contrast with *definite response* and *no response*.

**exchange identification (XID).** A specific type of basic link unit that is used to convey node and link characteristics between adjacent nodes. XIDs are exchanged between link stations before and during link activation to establish and negotiate link and node characteristics, and after link activation to communicate changes in these characteristics.

**explicit route (ER).** In SNA, a series of one or more transmission groups that connect two subarea nodes. An explicit route is identified by an origin subarea address, a destination subarea address, an explicit route number, and a reverse explicit route number. Contrast with *virtual route (VR)*.

**explorer frame.** See *explorer packet*.

**explorer packet.** In LANs, a packet that is generated by the source host and that traverses the entire source routing part of a LAN, gathering information on the possible paths available to the host.

**exterior gateway.** In Internet communications, a gateway on one autonomous system that communicates

with another autonomous system. Contrast with *interior gateway*.

**Exterior Gateway Protocol (EGP).** In the Internet suite of protocols, a protocol, used between domains and autonomous systems, that enables network reachability information to be advertised and exchanged. IP network addresses in one autonomous system are advertised to another autonomous system by means of EGP-participating routers. Contrast with *Border Gateway Protocol (BGP)*.

## F

**File Transfer Protocol (FTP).** In the Internet suite of protocols, an application layer protocol that uses TCP and Telnet services to transfer bulk-data files between machines or hosts.

**flow control.** (1) In SNA, the process of managing the rate at which data traffic passes between components of the network. The purpose of flow control is to optimize the rate of flow of message units with minimum congestion in the network; that is, to neither overflow the buffers at the receiver or at intermediate routing nodes, nor leave the receiver waiting for more message units. (2) See also  *pacing*.

**fragment.** See  *fragmentation*.

**fragmentation.** (1) The process of dividing a datagram into smaller parts, or fragments, to match the capabilities of the physical medium over which it is to be transmitted. (2) See also  *segmenting*.

**frame.** (1) In Open Systems Interconnection architecture, a data structure pertaining to a particular area of knowledge and consisting of slots that can accept the values of specific attributes and from which inferences can be drawn by appropriate procedural attachments. (T) (2) The unit of transmission in some local area networks, including the IBM Token-Ring Network. It includes delimiters, control characters, information, and checking characters. (3) In SDLC, the vehicle for every command, every response, and all information that is transmitted using SDLC procedures.

**frame level.** Synonymous with  *data link level*. See  *link level*.

**frame relay.** (1) An interface standard describing the boundary between a user's equipment and a fast-packet network. In frame-relay systems, flawed frames are discarded; recovery comes end-to-end rather than hop-by-hop. (2) A technique derived from the integrated services digital network (ISDN) D channel standard. It assumes that connections are reliable and dispenses with the overhead of error detection and control within the network.

## G

**gateway.** (1) A functional unit that interconnects two computer networks with different network architectures. A gateway connects networks or systems of different architectures. A bridge interconnects networks or systems with the same or similar architectures. (T) (2) In the IBM Token-Ring Network, a device and its associated software that connect a local area network to another local area network or a host that uses different logical link protocols. (3) In TCP/IP, synonym for  *router*.

**general data stream (GDS).** The data stream used for conversations in LU 6.2 sessions.

**general data stream (GDS) variable.** A type of RU substructure that is preceded by an identifier and a length field and includes either application data, user control data, or SNA-defined control data.

## H

**header.** (1) System-defined control information that precedes user data. (2) The portion of a message that contains control information for the message such as one or more destination fields, name of the originating station, input sequence number, character string indicating the type of message, and priority level for the message.

**heap memory.** The amount of RAM used to dynamically allocate data structures.

**Hello.** A protocol used by a group of cooperating, trusting routers to allow them to discover minimal delay routes.

**hello message.** (1) A message sent periodically to establish and test reachability between routers or between routers and hosts. (2) In the Internet suite of protocols, a message defined by the Hello protocol as an Interior Gateway Protocol (IGP).

**heuristic.** Pertaining to exploratory methods of problem solving in which solutions are discovered by evaluation of the progress made toward the final result.

**high-level data link control (HDLC).** In data communication, the use of a specified series of bits to control data links in accordance with the International Standards for HDLC: ISO 3309 Frame Structure and ISO 4335 Elements of Procedures.

**hop.** (1) In APPN, a portion of a route that has no intermediate nodes. It consists of only a single transmission group connecting adjacent nodes. (2) To the routing layer, the logical distance between two nodes in a network.

**hop count.** (1) A metric or measure of distance between two points. (2) In Internet communications, the number of routers that a datagram passes through on its way to its destination. (3) In SNA, a measure of the number of links to be traversed in a path to a destination.

**host.** In the Internet suite of protocols, an end system. The end system can be any workstation; it does not have to be a mainframe.

**hysteresis.** The amount the temperature must change past the set alert threshold before the alert condition is cleared.

## I

**I frame.** Information frame.

**IETF.** Internet Engineering Task Force, an organization that produces Internet specifications.

**ILMI.** Interim Local Management Interface, SNMP-based procedures for managing the User-Network Interface (UNI).

**information (I) frame.** A frame in I format used for numbered information transfer.

**input/output channel.** In a data processing system, a functional unit that handles transfer of data between internal and peripheral equipment. (I) (A)

**integrated services digital network (ISDN).** A digital end-to-end telecommunication network that supports multiple services including, but not limited to, voice and data.

**Note:** ISDNs are used in public and private network architectures.

**interface.** (1) A shared boundary between two functional units, defined by functional characteristics, signal characteristics, or other characteristics, as appropriate. The concept includes the specification of the connection of two devices having different functions. (T) (2) Hardware, software, or both, that links systems, programs, or devices.

**interior gateway.** In Internet communications, a gateway that communicates only with its own autonomous system. Contrast with *exterior gateway*.

**Interior Gateway Protocol (IGP).** In the Internet suite of protocols, a protocol used to propagate network reachability and routing information within an autonomous system. Examples of IGPs are Routing Information Protocol (RIP) and Open Shortest Path First (OSPF).

**intermediate node.** A node that is at the end of more than one branch. (T)

**intermediate session routing (ISR).** A type of routing function within an APPN network node that provides session-level flow control and outage reporting for all sessions that pass through the node but whose end points are elsewhere.

**International Organization for Standardization (ISO).** An organization of national standards bodies from various countries established to promote development of standards to facilitate international exchange of goods and services, and develop cooperation in intellectual, scientific, technological, and economic activity.

**International Telecommunication Union (ITU).** The specialized telecommunication agency of the United Nations, established to provide standardized communication procedures and practices, including frequency allocation and radio regulations worldwide.

**internet.** A collection of networks interconnected by a set of routers that allow them to function as a single, large network. See also *Internet*.

**Internet.** The internet administered by the Internet Architecture Board (IAB), consisting of large national backbone networks and many regional and campus networks all over the world. The Internet uses the Internet suite of protocols.

**Internet address.** See *IP address*.

**Internet Architecture Board (IAB).** The technical body that oversees the development of the Internet suite of protocols that are known as TCP/IP.

**Internet Control Message Protocol (ICMP).** The protocol used to handle errors and control messages in the Internet Protocol (IP) layer. Reports of problems and incorrect datagram destinations are returned to the original datagram source. ICMP is part of the Internet Protocol.

**Internet Control Protocol (ICP).** The Virtual NETworking System (VINES) protocol that provides exception notifications, metric notifications, and PING support. See also *RouTing update Protocol (RTP)*.

**Internet Engineering Task Force (IETF).** The task force of the Internet Architecture Board (IAB) that is responsible for solving the short-term engineering needs of the Internet.

**Internet Protocol (IP).** A connectionless protocol that routes data through a network or interconnected networks. IP acts as an intermediary between the higher protocol layers and the physical network. However, this protocol does not provide error recovery

and flow control and does not guarantee the reliability of the physical network.

**Internetwork Packet Exchange (IPX).** (1) The network protocol used to connect Novell's servers, or any workstation or router that implements IPX, with other workstations. Although similar to the Internet Protocol (IP), IPX uses different packet formats and terminology. (2) See also *Xerox Network Systems (XNS)*.

**interoperability.** The capability to communicate, execute programs, or transfer data among various functional units in a way that requires the user to have little or no knowledge of the unique characteristics of those units. (T)

**intra-area routing.** In Internet communications, the routing of data within an area.

**Inverse Address Resolution Protocol (InARP).** In the Internet suite of protocols, the protocol used for locating a protocol address through the known hardware address. In a frame-relay context, the data link connection identifier (DLCI) is synonymous with the known hardware address.

**IP address.** The 32-bit address defined by the Internet Protocol, standard 5, Request for Comments (RFC) 791. It is usually represented in dotted decimal notation.

**IP datagram.** In the Internet suite of protocols, the fundamental unit of information transmitted through an internet. It contains source and destination addresses, user data, and control information such as the length of the datagram, the header checksum, and flags indicating whether the datagram can be or has been fragmented.

**IP router.** A device in an IP internet that is responsible for making decisions about the paths over which network traffic will flow. Routing protocols are used to gain information about the network and to determine the best route over which the datagram should be forwarded toward the final destination. The datagrams are routed based on IP destination addresses.

**IPXWAN.** A Novell protocol that is used to exchange router-to-router information before exchanging standard Internetwork Packet Exchange (IPX) routing information and traffic over wide area networks (WANs).

## L

**LAN bridge server (LBS).** In the IBM Token-Ring Network Bridge Program, the server that keeps statistical information about frames forwarded between two or more rings (through a bridge). The LBS sends these statistics to the appropriate LAN managers through the LAN reporting mechanism (LRM).

**LAN Emulation (LE).** An ATM Forum standard that supports legacy LAN applications over ATM networks.

**LAN Emulation Client (LEC).** A LAN Emulation component that represents users of the Emulated LAN.

**LAN Emulation Configuration Server (LECS).** A LAN Emulation Service component that centralizes and disseminates configuration data.

**LAN Emulation Server (LES).** A LAN Emulation Service component that resolves LAN Destinations to ATM Addresses.

**LAN Network Manager (LNM).** An IBM licensed program that enables a user to manage and monitor LAN resources from a central workstation.

**LAN segment.** (1) Any portion of a LAN (for example, a bus or ring) that can operate independently, but that is connected to other parts of the network by means of bridges. (2) A ring or bus network without bridges.

**layer.** (1) In network architecture, a group of services that is complete from a conceptual point of view, that is one out of a set of hierarchically arranged groups, and that extends across all systems that conform to the network architecture. (T) (2) In the Open Systems Interconnection reference model, one of seven conceptually complete, hierarchically arranged groups of services, functions, and protocols, that extend across all open systems. (T) (3) In SNA, a grouping of related functions that are logically separate from the functions in other groups. Implementation of the functions in one layer can be changed without affecting functions in other layers.

**LE.** LAN Emulation.

**LEC.** LAN Emulation Client.

**LECS.** LAN Emulation Configuration Server.

**LES.** LAN Emulation Server.

**line switching.** Synonym for *circuit switching*.

**link.** The combination of the link connection (the transmission medium) and two link stations, one at each end of the link connection. A link connection can be

shared among multiple links in a multipoint or token-ring configuration.

**link access protocol balanced (LAPB).** A protocol used for accessing an X.25 network at the link level. LAPB is a duplex, asynchronous, symmetric protocol, used in point-to-point communication.

**link-attached.** (1) Pertaining to devices that are connected to a controlling unit by a data link. (2) Contrast with *channel-attached*. (3) Synonymous with *remote*.

**link connection.** (1) The physical equipment providing two-way communication between one link station and one or more other link stations; for example, a telecommunication line and data circuit-terminating equipment (DCE). (2) In SNA, synonymous with *data circuit*.

**link level.** (1) A part of Recommendation X.25 that defines the link protocol used to get data into and out of the network across the full-duplex link connecting the subscriber's machine to the network node. LAP and LAPB are the link access protocols recommended by the CCITT. (2) See *data link level*.

**link-state.** In routing protocols, the advertised information about the usable interfaces and reachable neighbors of a router or network. The protocol's topological database is formed from the collected link-state advertisements.

**link station.** (1) The hardware and software components within a node representing a connection to an adjacent node over a specific link. For example, if node A is the primary end of a multipoint line that connects to three adjacent nodes, node A will have three link stations representing the connections to the adjacent nodes. (2) See also *adjacent link station (ALS)*.

**LIS.** Logical IP Subnet, an IP subnet implemented with ATM technology Virtual Networking (SVN) framework.

**local.** (1) Pertaining to a device accessed directly without use of a telecommunication line. (2) Contrast with *remote*. (3) Synonym for *channel-attached*.

**local area network (LAN).** (1) A computer network located on a user's premises within a limited geographical area. Communication within a local area network is not subject to external regulations; however, communication across the LAN boundary may be subject to some form of regulation. (T) (2) A network in which a set of devices are connected to one another for communication and that can be connected to a larger network. (3) See also *Ethernet* and *token ring*. (4) Contrast with *metropolitan area network (MAN)* and *wide area network (WAN)*.

**local bridging.** A function of a bridge program that allows a single bridge to connect multiple LAN segments without using a telecommunication link. Contrast with *remote bridging*.

**local management interface (LMI).** See *local management interface (LMI) protocol*.

**local management interface (LMI) protocol.** In NCP, a set of frame-relay network management procedures and messages used by adjacent frame-relay nodes to exchange line status information over DLCI X'00'. NCP supports both the American National Standards Institute (ANSI) and International Telegraph and Telephone Consultative Committee (ITU-T/CCITT) versions of LMI protocol. These standards refer to LMI protocol as *link integrity verification tests (LIVT)*.

**locally administered address.** In a local area network, an adapter address that the user can assign to override the universally administered address. Contrast with *universally administered address*.

**logical channel.** In packet mode operation, a sending channel and a receiving channel that together are used to send and receive data over a data link at the same time. Several logical channels can be established on the same data link by interleaving the transmission of packets.

**logical link.** A pair of link stations, one in each of two adjacent nodes, and their underlying link connection, providing a single link-layer connection between the two nodes. Multiple logical links can be distinguished while they share the use of the same physical media connecting two nodes. Examples are 802.2 logical links used on local area network (LAN) facilities and LAP E logical links on the same point-to-point physical link between two nodes. The term logical link also includes the multiple X.25 logical channels that share the use of the access link from a DTE to an X.25 network.

**logical link control (LLC).** The data link control (DLC) LAN sublayer that provides two types of DLC operation for the orderly exchange of information. The first type is connectionless service, which allows information to be sent and received without establishing a link. The LLC sublayer does not perform error recovery or flow control for connectionless service. The second type is connection-oriented service, which requires establishing a link prior to the exchange of information. Connection-oriented service provides sequenced information transfer, flow control, and error recovery.

**logical link control (LLC) protocol.** In a local area network, the protocol that governs the exchange of transmission frames between data stations independently of how the transmission medium is shared. (T) The LLC protocol was developed by the



IEEE 802 committee and is common to all LAN standards.

**logical link control (LLC) protocol data unit.** A unit of information exchanged between link stations in different nodes. The LLC protocol data unit contains a destination service access point (DSAP), a source service access point (SSAP), a control field, and user data.

**logical unit (LU).** A type of network accessible unit that enables users to gain access to network resources and communicate with each other.

**loopback test.** A test in which signals from a tester are looped at a modem or other network element back to the tester for measurements that determine or verify the quality of the communications path.

**low-entry networking (LEN).** A capability of nodes to attach directly to one another using basic peer-to-peer protocols to support multiple and parallel sessions between logical units.

**low-entry networking (LEN) end node.** A LEN node receiving network services from an adjacent APPN network node.

**low-entry networking (LEN) node.** A node that provides a range of end-user services, attaches directly to other nodes using peer protocols, and derives network services implicitly from an adjacent APPN network node, that is, without the direct use of CP-CP sessions.

## M

**Management Information Base (MIB).** (1) A collection of objects that can be accessed by means of a network management protocol. (2) A definition for management information that specifies the information available from a host or gateway and the operations allowed. (3) In OSI, the conceptual repository of management information within an open system.

**management station.** In Internet communications, the system responsible for managing all, or a portion of, a network. The management station communicates with network management agents that reside in the managed node by means of a network management protocol, such as the Simple Network Management Protocol (SNMP).

**mapping.** The process of converting data that is transmitted in one format by the sender into the data format that can be accepted by the receiver.

**mask.** (1) A pattern of characters used to control retention or elimination of portions of another pattern of characters. (l) (A) (2) To use a pattern of characters to

control retention or elimination of portions of another pattern of characters. (l) (A)

**maximum transmission unit (MTU).** In LANs, the largest possible unit of data that can be sent on a given physical medium in a single frame. For example, the MTU for Ethernet is 1500 bytes.

**medium access control (MAC).** In LANs, the sublayer of the data link control layer that supports medium-dependent functions and uses the services of the physical layer to provide services to the logical link control (LLC) sublayer. The MAC sublayer includes the method of determining when a device has access to the transmission medium.

**medium access control (MAC) protocol.** In a local area network, the protocol that governs access to the transmission medium, taking into account the topological aspects of the network, in order to enable the exchange of data between data stations. (T)

**medium access control (MAC) sublayer.** In a local area network, the part of the data link layer that applies a medium access method. The MAC sublayer supports topology-dependent functions and uses the services of the physical layer to provide services to the logical link control sublayer. (T)

**metric.** In Internet communications, a value, associated with a route, which is used to discriminate between multiple exit or entry points to the same autonomous system. The route with the lowest metric is preferred.

**metropolitan area network (MAN).** A network formed by the interconnection of two or more networks which may operate at higher speed than those networks, may cross administrative boundaries, and may use multiple access methods. (T) Contrast with *local area network (LAN)* and *wide area network (WAN)*.

**MIB object.** Synonym for *MIB variable*.

**MIB variable.** In the Simple Network Management Protocol (SNMP), a specific instance of data defined in a MIB module. Synonymous with *MIB object*.

**MIB view.** In the Simple Network Management Protocol (SNMP), the collection of managed objects, known to the agent, that is visible to a particular community.

**MILNET.** The military network that was originally part of ARPANET. It was partitioned from ARPANET in 1984. MILNET provides a reliable network service for military installations.

**modem (modulator/demodulator).** (1) A functional unit that modulates and demodulates signals. One of the functions of a modem is to enable digital data to be

transmitted over analog transmission facilities. (T) (A) (2) A device that converts digital data from a computer to an analog signal that can be transmitted on a telecommunication line, and converts the analog signal received to data for the computer.

**modulo.** (1) Pertaining to a modulus; for example, 9 is equivalent to 4 modulo 5. (2) See also *modulus*.

**modulus.** A number, such as a positive integer, in a relationship that divides the difference between two related numbers without leaving a remainder; for example, 9 and 4 have a modulus of 5 ( $9 - 4 = 5$ ;  $4 - 9 = -5$ ; and 5 divides both 5 and -5 without leaving a remainder).

**monitor.** (1) A device that observes and records selected activities within a data processing system for analysis. Possible uses are to indicate significant departure from the norm, or to determine levels of utilization of particular functional units. (T) (2) Software or hardware that observes, supervises, controls, or verifies operations of a system. (A) (3) The function required to initiate the transmission of a token on the ring and to provide soft-error recovery in case of lost tokens, circulating frames, or other difficulties. The capability is present in all ring stations.

**MSS.** Multiprotocol Switched Services, a component of IBM's Switched Virtual Networking (SVN) framework.

**multicast.** (1) Transmission of the same data to a selected group of destinations. (T) (2) A special form of broadcast in which copies of a packet are delivered to only a subset of all possible destinations.

**multiple-domain support (MDS).** A technique for transporting management services data between management services function sets over LU-LU and CP-CP sessions. See also *multiple-domain support message unit (MDS-MU)*.

**multiple-domain support message unit (MDS-MU).** The message unit that contains management services data and flows between management services function sets over the LU-LU and CP-CP sessions used by multiple-domain support. This message unit, as well as the actual management services data that it contains, is in general data stream (GDS) format. See also *control point management services unit (CP-MSU)*, *management services unit (MSU)*, and *network management vector transport (NMVT)*.

## N

**Name Binding Protocol (NBP).** In AppleTalk networks, a protocol that provides name translation function from the AppleTalk entity (resource) name (character string) into an AppleTalk IP address (16-bit number) on the transport layer.

**name resolution.** In Internet communications, the process of mapping a machine name to the corresponding Internet Protocol (IP) address. See also *Domain Name System (DNS)*.

**name server.** In the Internet suite of protocols, synonym for *domain name server*.

**nearest active upstream neighbor (NAUN).** In the IBM Token-Ring Network, the station sending data directly to a given station on the ring.

**neighbor.** A router on a common subnetwork that has been designated by a network administrator to receive routing information.

**NetBIOS.** Network Basic Input/Output System. A standard interface to networks, IBM personal computers (PCs), and compatible PCs, that is used on LANs to provide message, print-server, and file-server functions. Application programs that use NetBIOS do not need to handle the details of LAN data link control (DLC) protocols.

**network.** (1) A configuration of data processing devices and software connected for information interchange. (2) A group of nodes and the links interconnecting them.

**network accessible unit (NAU).** A logical unit (LU), physical unit (PU), control point (CP), or system services control point (SSCP). It is the origin or the destination of information transmitted by the path control network. Synonymous with *network addressable unit*.

**network address.** According to ISO 7498-3, a name, unambiguous within the OSI environment, that identifies a set of network service access points.

**network addressable unit (NAU).** Synonym for *network accessible unit*.

**network architecture.** The logical structure and operating principles of a computer network. (T)

**Note:** The operating principles of a network include those of services, functions, and protocols.

**network congestion.** An undesirable overload condition caused by traffic in excess of what a network can handle.

**network identifier.** (1) In TCP/IP, that part of the IP address that defines a network. The length of the network ID depends on the type of network class (A, B, or C). (2) A 1- to 8-byte customer-selected name or an 8-byte IBM-registered name that uniquely identifies a specific subnetwork.

**Network Information Center (NIC).** In Internet communications, local, regional, and national groups throughout the world who provide assistance, documentation, training, and other services to users.

**network layer.** In Open Systems Interconnection (OSI) architecture, the layer that is responsible for routing, switching, and link-layer access across the OSI environment.

**network management.** The process of planning, organizing, and controlling a communication-oriented data processing or information system.

**network management station.** In the Simple Network Management Protocol (SNMP), a station that executes management application programs that monitor and control network elements.

**network management vector transport (NMVT).** A management services request/response unit (RU) that flows over an active session between physical unit management services and control point management services (SSCP-PU session).

**network manager.** A program or group of programs that is used to monitor, manage, and diagnose the problems of a network.

**network node (NN).** See *Advanced Peer-to-Peer Networking (APPN) network node*.

**Next Hop Resolution Protocol (NHRP).** A routing protocol, specified in Internet Draft Version 10 which has been submitted for RFC status. The Next Hop Resolution Protocol defines a method for a source station to determine the Non-Broadcast Multi-Access (NBMA) address of the "NBMA next hop" towards a destination. The NBMA next hop may be the destination itself or the router in the NBMA network that is "nearest" to the destination. The source station can then establish an NBMA virtual circuit directly with the destination or the router and reduce the number of routing hops through the NBMA network.

**network user address (NUA).** In X.25 communications, the X.121 address containing up to 15 binary code digits.

**NHRP.** Next Hop Resolution Protocol

**node.** (1) In a network, a point at which one or more functional units connect channels or data circuits. (I) (2) Any device, attached to a network, that transmits and receives data.

**noncanonical address.** In LANs, a format for the transmission of medium access control (MAC) addresses for token-ring adapters. In noncanonical format, the most significant (leftmost) bit of each address byte is transmitted first. Contrast with *canonical address*.

**nonseed router.** In AppleTalk networks, a router that acquires network number range and zone list information from a seed router attached to the same network.

## O

**Open Shortest Path First (OSPF).** In the Internet suite of protocols, a function that provides intradomain information transfer. An alternative to the Routing Information Protocol (RIP), OSPF allows the lowest-cost routing and handles routing in large regional or corporate networks.

**Open Systems Interconnection (OSI).** (1) The interconnection of open systems in accordance with standards of the International Organization for Standardization (ISO) for the exchange of information. (T) (A) (2) The use of standardized procedures to enable the interconnection of data processing systems.

**Note:** OSI architecture establishes a framework for coordinating the development of current and future standards for the interconnection of computer systems. Network functions are divided into seven layers. Each layer represents a group of related data processing and communication functions that can be carried out in a standard way to support different applications.

**Open Systems Interconnection (OSI) architecture.** Network architecture that adheres to that particular set of ISO standards that relates to Open Systems Interconnection. (T)

**Open Systems Interconnection (OSI) reference model.** A model that describes the general principles of the Open Systems Interconnection, as well as the purpose and the hierarchical arrangement of its seven layers. (T)

**origin.** An external logical unit (LU) or application program from which a message or other data originates. See also *destination*.

**orphan circuit.** A non-configured circuit whose availability is learned dynamically.

## P

**padding.** (1) A technique by which a receiving component controls the rate of transmission of a sending component to prevent overrun or congestion. (2) See also *flow control*, *receive pacing*, *send pacing*, *session-level pacing*, and *virtual route (VR) pacing*.

**packet.** In data communication, a sequence of binary digits, including data and control signals, that is transmitted and switched as a composite whole. The data, control signals, and, possibly, error control information are arranged in a specific format. (I)

**packet internet groper (PING).** (1) In Internet communications, a program used in TCP/IP networks to test the ability to reach destinations by sending the destinations an Internet Control Message Protocol (ICMP) echo request and waiting for a reply. (2) In communications, a test of reachability.

**packet mode operation.** Synonym for *packet switching*.

**packet switching.** (1) The process of routing and transferring data by means of addressed packets so that a channel is occupied only during transmission of a packet. On completion of the transmission, the channel is made available for transfer of other packets. (I) (2) Synonymous with *packet mode operation*. See also *circuit switching*.

**parallel bridges.** A pair of bridges connected to the same LAN segment, creating redundant paths to the segment.

**parallel transmission groups.** Multiple transmission groups between adjacent nodes, with each group having a distinct transmission group number.

**path.** (1) In a network, any route between any two nodes. A path may include more than one branch. (T) (2) The series of transport network components (path control and data link control) that are traversed by the information exchanged between two network accessible units. See also *explicit route (ER)*, *route extension*, and *virtual route (VR)*.

**path control (PC).** The function that routes message units between network accessible units in the network and provides the paths between them. It converts the basic information units (BIUs) from transmission control (possibly segmenting them) into path information units (PIUs) and exchanges basic transmission units containing one or more PIUs with data link control. Path control differs by node type: some nodes (APPN nodes, for example) use locally generated session identifiers for routing, and others (subarea nodes) use network addresses for routing.

**path cost.** In link-state routing protocols, the sum of the link costs along the path between two nodes or networks.

**path information unit (PIU).** A message unit consisting of a transmission header (TH) alone, or a TH followed by a basic information unit (BIU) or a BIU segment.

**pattern-matching character.** A special character such as an asterisk (\*) or a question mark (?) that can be used to represent one or more characters. Any character or set of characters can replace a pattern-matching character. Synonymous with *global character* and *wildcard character*.

**permanent virtual circuit (PVC).** In X.25 and frame-relay communications, a virtual circuit that has a logical channel permanently assigned to it at each data terminal equipment (DTE). Call-establishment protocols are not required. Contrast with *switched virtual circuit (SVC)*.

**physical circuit.** A circuit established without multiplexing. See also *data circuit*. Contrast with *virtual circuit*.

**physical layer.** In the Open Systems Interconnection reference model, the layer that provides the mechanical, electrical, functional, and procedural means to establish, maintain, and release physical connections over the transmission medium. (T)

**physical unit (PU).** (1) The component that manages and monitors the resources (such as attached links and adjacent link stations) associated with a node, as requested by an SSCP via an SSCP-PU session. An SSCP activates a session with the physical unit in order to indirectly manage, through the PU, resources of the node such as attached links. This term applies to type 2.0, type 4, and type 5 nodes only. (2) See also *peripheral PU* and *subarea PU*.

**ping command.** The command that sends an Internet Control Message Protocol (ICMP) echo-request packet to a gateway, router, or host with the expectation of receiving a reply.

**Point-to-Point Protocol (PPP).** A protocol that provides a method for encapsulating and transmitting packets over serial point-to-point links.

**polling.** (1) On a multipoint connection or a point-to-point connection, the process whereby data stations are invited, one at a time, to transmit. (I) (2) Interrogation of devices for such purposes as to avoid contention, to determine operational status, or to determine readiness to send or receive data. (A)

**port.** (1) An access point for data entry or exit. (2) A connector on a device to which cables for other devices

such as display stations and printers are attached. (3) The representation of a physical connection to the link hardware. A port is sometimes referred to as an adapter; however, there can be more than one port on an adapter. There may be one or more ports controlled by a single DLC process. (4) In the Internet suite of protocols, a 16-bit number used to communicate between TCP or the User Datagram Protocol (UDP) and a higher-level protocol or application. Some protocols, such as File Transfer Protocol (FTP) and Simple Mail Transfer Protocol (SMTP), use the same well-known port number in all TCP/IP implementations. (5) An abstraction used by transport protocols to distinguish among multiple destinations within a host machine. (6) Synonymous with *socket*.

**port number.** In Internet communications, the identification of an application entity to the transport service.

**problem determination.** The process of determining the source of a problem; for example, a program component, machine failure, telecommunication facilities, user or contractor-installed programs or equipment, environmental failure such as a power loss, or user error.

**program temporary fix (PTF).** A temporary solution or bypass of a problem diagnosed by IBM in a current unaltered release of the program.

**protocol.** (1) A set of semantic and syntactic rules that determine the behavior of functional units in achieving communication. (I) (2) In Open Systems Interconnection architecture, a set of semantic and syntactic rules that determine the behavior of entities in the same layer in performing communication functions. (T) (3) In SNA, the meanings of, and the sequencing rules for, requests and responses used for managing the network, transferring data, and synchronizing the states of network components. Synonymous with *line control discipline* and *line discipline*. See *bracket protocol* and *link protocol*.

**protocol data unit (PDU).** A unit of data specified in a protocol of a given layer and consisting of protocol control information of this layer, and possibly user data of this layer. (T)

## Q

**Quality of Service (QoS).** The user-oriented performance of an end-to-end service which is accessed using performance parameters. In ATM networks, the following performance parameters determine the QoS of an end-to-end ATM connection: cell loss ratio, cell transfer delay, and cell delay variation.

## R

**Rapid Transport Protocol (RTP) connection.** In high-performance routing (HPR), the connection established between the endpoints of the route to transport session traffic.

**reachability.** The ability of a node or a resource to communicate with another node or resource.

**read-only memory (ROM).** Memory in which stored data cannot be modified by the user except under special conditions.

**reassembly.** In communications, the process of putting segmented packets back together after they have been received.

**receive not ready (RNR).** In communications, a data link command or response that indicates a temporary condition of being unable to accept incoming frames.

**receive not ready (RNR) packet.** See *RNR packet*.

**received line signal detector (RLSD).** In the EIA 232 standard, a signal that indicates to the data terminal equipment (DTE) that it is receiving a signal from the remote data circuit-terminating equipment (DCE). Synonymous with *carrier detect* and *data carrier detect (DCD)*.

**Recognized Private Operating Agency (RPOA).** Any individual, company, or corporation, other than a government department or service, that operates a telecommunication service and is subject to the obligations undertaken in the Convention of the International Telecommunication Union and in the Regulations; for example, a communication common carrier.

**reduced instruction-set computer (RISC).** A computer that uses a small, simplified set of frequently used instructions for rapid execution.

**remote.** (1) Pertaining to a system, program, or device that is accessed through a telecommunication line. (2) Synonym for *link-attached*. (3) Contrast with *local*.

**remote bridging.** The function of a bridge that allows two bridges to connect multiple LANs using a telecommunication link. Contrast with *local bridging*.

**Remote Execution Protocol (REXEC).** A protocol that allows the execution of a command or program on any host in the network. The local host receives the results of the command execution.

**Request for Comments (RFC).** In Internet communications, the document series that describes a part of the Internet suite of protocols and related

experiments. All Internet standards are documented as RFCs.

**reset.** On a virtual circuit, reinitialization of data flow control. At reset, all data in transit are eliminated.

**reset request packet.** In X.25 communications, a packet transmitted by the data terminal equipment (DTE) to the data circuit-terminating equipment (DCE) to request that a virtual call or a permanent virtual circuit be reset. The reason for the request can also be specified in the packet.

**ring.** See *ring network*.

**ring network.** (1) A network in which every node has exactly two branches connected to it and in which there are exactly two paths between any two nodes. (T)  
(2) A network configuration in which devices are connected by unidirectional transmission links to form a closed path.

**ring segment.** A section of a ring that can be isolated (by unplugging connectors) from the rest of the ring. See *LAN segment*.

**rlogin (remote login).** A service, offered by Berkeley UNIX-based systems, that allows authorized users of one machine to connect to other UNIX systems across an internet and interact as if their terminals were connected directly. The rlogin software passes information about the user's environment (for example, terminal type) to the remote machine.

**RNR packet.** A packet used by a data terminal equipment (DTE) or by a data circuit-terminating equipment (DCE) to indicate a temporary inability to accept additional packets for a virtual call or permanent virtual circuit.

**root bridge.** The bridge that is the root of a spanning tree formed between other active bridges in the bridging network. The root bridge originates and transmits bridge protocol data units (BPDUs) to other active bridges to maintain the spanning tree topology. It is the bridge with the highest priority in the network.

**route.** (1) An ordered sequence of nodes and transmission groups (TGs) that represent a path from an origin node to a destination node traversed by the traffic exchanged between them. (2) The path that network traffic uses to get from source to destination.

**route bridge.** A function of an IBM bridge program that allows two bridge computers to use a telecommunication link to connect two LANs. Each bridge computer is connected directly to one of the LANs, and the telecommunication link connects the two bridge computers.

**route extension (REX).** In SNA, the path control network components, including a peripheral link, that make up the portion of a path between a subarea node and a network addressable unit (NAU) in an adjacent peripheral node. See also *explicit route (ER)*, *path*, and *virtual route (VR)*.

**Route Selection control vector (RSCV).** A control vector that describes a route within an APPN network. The RSCV consists of an ordered sequence of control vectors that identify the TGs and nodes that make up the path from an origin node to a destination node.

**router.** (1) A computer that determines the path of network traffic flow. The path selection is made from several paths based on information obtained from specific protocols, algorithms that attempt to identify the shortest or best path, and other criteria such as metrics or protocol-specific destination addresses. (2) An attaching device that connects two LAN segments, which use similar or different architectures, at the reference model network layer. (3) In OSI terminology, a function that determines a path by which an entity can be reached. (4) In TCP/IP, synonymous with *gateway*. (5) Contrast with *bridge*.

**routing.** (1) The assignment of the path by which a message is to reach its destination. (2) In SNA, the forwarding of a message unit along a particular path through a network, as determined by parameters carried in the message unit, such as the destination network address in a transmission header.

**routing domain.** In Internet communications, a group of intermediate systems that use a routing protocol so that the representation of the overall network is the same within each intermediate system. Routing domains are connected to each other by exterior links.

**Routing Information Protocol (RIP).** In the Internet suite of protocols, an interior gateway protocol used to exchange intradomain routing information and to determine optimum routes between internet hosts. RIP determines optimum routes on the basis of route metrics, not link transmission speed.

**routing loop.** A situation that occurs when routers circulate information among themselves until convergence occurs or until the networks involved are considered unreachable.

**routing protocol.** A technique used by a router to find other routers and to remain up to date about the best way to get to reachable networks.

**routing table.** A collection of routes used to direct datagram forwarding or to establish a connection. The information is passed among routers to identify network topology and destination feasibility.

**Routing Table Maintenance Protocol (RTMP).** In AppleTalk networks, a protocol that provides routing information generation and maintenance on the transport layer by means of the AppleTalk routing table. The AppleTalk routing table directs packet transmission through the internet from source socket to destination socket.

**RouTing update Protocol (RTP).** The VIRTUAL NETworking System (VINES) protocol that maintains the routing database and allows the exchange of routing information between VINES nodes. See also *Internet Control Protocol (ICP)*.

**rsh.** A variant of the rlogin command that invokes a command interpreter on a remote UNIX machine and passes the command-line arguments to the command interpreter, skipping the login step completely.

## S

**SDU.** Service Data Unit, data as it appears at the interface between a layer and the layer immediately above.

**seed router.** In AppleTalk networks, a router that maintains configuration data (network range numbers and zone lists, for example) for the network. Each network must have at least one seed router. The seed router must be initially set up using the configurator tool. Contrast with *nonseed router*.

**segment.** (1) A section of cable between components or devices. A segment may consist of a single patch cable, several patch cables that are connected, or a combination of building cable and patch cables that are connected. (2) In Internet communications, the unit of transfer between TCP functions in different machines. Each segment contains control and data fields; the current byte-stream position and actual data bytes are identified along with a checksum to validate received data.

**segmenting.** In OSI, a function performed by a layer to map one protocol data unit (PDU) from the layer it supports into multiple PDUs.

**sequence number.** In communications, a number assigned to a particular frame or packet to control the transmission flow and receipt of data.

**server.** A functional unit that provides shared services to workstations over a network; for example, a file server, a print server, a mail server. (T)

**service access point (SAP).** (1) In Open Systems Interconnection (OSI) architecture, the point at which the services of a layer are provided by an entity of that layer to an entity of the next higher layer. (T) (2) A logical point made available by an adapter where

information can be received and transmitted. A single service access point can have many links terminating in it.

**Service Advertising Protocol (SAP).** In Internetwork Packet Exchange (IPX), a protocol that provides the following:

- A mechanism that allows IPX servers on an internet to advertise their services by name and type. Servers using this protocol have their name, service type, and IP address recorded in all file servers running NetWare.
- A mechanism that allows a workstation to broadcast a query to discover the identities of all servers of all types, all servers of a specific type, or the nearest server of a specific type.
- A mechanism that allows a workstation to query any file server running NetWare to discover the names and addresses of all servers of a specific type.

**session.** (1) In network architecture, for the purpose of data communication between functional units, all the activities which take place during the establishment, maintenance, and release of the connection. (T)

(2) A logical connection between two network accessible units (NAUs) that can be activated, tailored to provide various protocols, and deactivated, as requested. Each session is uniquely identified in a transmission header (TH) accompanying any transmissions exchanged during the session.

**Simple Network Management Protocol (SNMP).** In the Internet suite of protocols, a network management protocol that is used to monitor routers and attached networks. SNMP is an application layer protocol. Information on devices managed is defined and stored in the application's Management Information Base (MIB).

**SLIP.** Serial Line IP, an IETF standard for running IP over serial communication links.

**SNA management services (SNA/MS).** The services provided to assist in management of SNA networks.

**SNAP.** (1) SubNetwork Access Protocol.  
(2) SubNetwork Attachment Point.

**socket.** An endpoint for communication between processes or application programs.

**source route bridging.** In LANs, a bridging method that uses the routing information field in the IEEE 802.5 medium access control (MAC) header of a frame to determine which rings or token-ring segments the frame must transit. The routing information field is inserted into the MAC header by the source node. The information in the routing information field is derived from explorer packets generated by the source host.

**source routing.** In LANs, a method by which the sending station determines the route the frame will follow and includes the routing information with the frame. Bridges then read the routing information to determine whether they should forward the frame.

**source service access point (SSAP).** In SNA and TCP/IP, a logical address that allows a system to send data to a remote device from the appropriate communications support. Contrast with *destination service access point (DSAP)*.

**spanning tree.** In LAN contexts, the method by which bridges automatically develop a routing table and update that table in response to changing topology to ensure that there is only one route between any two LANs in the bridged network. This method prevents packet looping, where a packet returns in a circuitous route back to the sending router.

**sphere of control (SOC).** The set of control point domains served by a single management services focal point.

**sphere of control (SOC) node.** A node directly in the sphere of control of a focal point. A SOC node has exchanged management services capabilities with its focal point. An APPN end node can be a SOC node if it supports the function to exchange management services capabilities.

**split horizon.** A technique for minimizing the time to achieve network convergence. A router records the interface over which it received a particular route and does not propagate its information about the route back over the same interface.

**spoofing.** For data links, a technique in which a protocol initiated from an end station is acknowledged and processed by an intermediate node on behalf of the final destination. In IBM 6611 data link switching, for example, SNA frames are encapsulated into TCP/IP packets for transport across a non-SNA wide area network, unpacked by another IBM 6611, and passed to the final destination. A benefit of spoofing is the prevention of end-to-end session timeouts.

**standard MIB.** In the Simple Network Management Protocol (SNMP), a MIB module that is located under the management branch of the Structure of Management Information (SMI) and that is considered a standard by the Internet Engineering Task Force (IETF).

**static route.** The route between hosts, networks, or both that is manually entered into a routing table.

**station.** An input or output point of a system that uses telecommunication facilities; for example, one or more systems, computers, terminals, devices, and associated programs at a particular location that can send or receive data over a telecommunication line.

**StreetTalk.** In the Virtual Networking System (VINES), a unique network-wide naming and addressing system that allows users to locate and access any resource on the network without knowing the network topology. See also *Internet Control Protocol (ICP)* and *Routing update Protocol (RTP)*.

**Structure of Management Information (SMI).** (1) In the Simple Network Management Protocol (SNMP), the rules used to define the objects that can be accessed by means of a network management protocol. (2) In OSI, the set of standards relating to management information. The set includes the *Management Information Model* and the *Guidelines for the Definition of Managed Objects*.

**subarea.** A portion of the SNA network consisting of a subarea node, attached peripheral nodes, and associated resources. Within a subarea node, all network accessible units (NAUs), links, and adjacent link stations (in attached peripheral or subarea nodes) that are addressable within the subarea share a common subarea address and have distinct element addresses.

**subnet.** (1) In TCP/IP, a part of a network that is identified by a portion of the IP address. (2) Synonym for *subnetwork*.

**subnet address.** In Internet communications, an extension to the basic IP addressing scheme where a portion of the host address is interpreted as the local network address.

**subnet mask.** Synonym for *address mask*.

**subnetwork.** (1) Any group of nodes that have a set of common characteristics, such as the same network ID. (2) Synonymous with *subnet*.

**Subnetwork Access Protocol (SNAP).** In LANs, a 5-byte protocol discriminator that identifies the non-IEEE standard protocol family to which a packet belongs. The SNAP value is used to differentiate between protocols that use \$AA as their service access point (SAP) value.

**SubNetwork Attachment Point (SNAP).** An LLC header extension that identifies the protocol type of a frame.

**subnetwork mask.** Synonym for *address mask*.

**subsystem.** A secondary or subordinate system, usually capable of operating independently of, or asynchronously with, a controlling system. (T)

**SVN.** Switched Virtual Networking, the name of IBM's framework for building and managing switch-based networks.



**switched virtual circuit (SVC).** An X.25 circuit that is dynamically established when needed. The X.25 equivalent of a switched line. Contrast with *permanent virtual circuit (PVC)*.

**synchronous.** (1) Pertaining to two or more processes that depend upon the occurrence of specific events such as common timing signals. (T)  
(2) Occurring with a regular or predictable time relationship.

**Synchronous Data Link Control (SDLC).** (1) A discipline conforming to subsets of the Advanced Data Communication Control Procedures (ADCCP) of the American National Standards Institute (ANSI) and High-level Data Link Control (HDLC) of the International Organization for Standardization, for managing synchronous, code-transparent, serial-by-bit information transfer over a link connection. Transmission exchanges may be duplex or half-duplex over switched or nonswitched links. The configuration of the link connection may be point-to-point, multipoint, or loop. (I)  
(2) Contrast with *binary synchronous communication (BSC)*.

**SYNTAX.** In the Simple Network Management Protocol (SNMP), a clause in the MIB module that defines the abstract data structure that corresponds to a managed object.

**system configuration.** A process that specifies the devices and programs that form a particular data processing system.

**system services control point (SSCP).** A component within a subarea network for managing the configuration, coordinating network operator and problem determination requests, and providing directory services and other session services for users of the network. Multiple SSCPs, cooperating as peers with one another, can divide the network into domains of control, with each SSCP having a hierarchical control relationship to the physical units and logical units within its own domain.

**Systems Network Architecture (SNA).** The description of the logical structure, formats, protocols, and operational sequences for transmitting information units through, and controlling the configuration and operation of, networks. The layered structure of SNA allows the ultimate origins and destinations of information, that is, the users, to be independent of and unaffected by the specific SNA network services and facilities used for information exchange.

## T

**Telnet.** In the Internet suite of protocols, a protocol that provides remote terminal connection service. It allows users of one host to log on to a remote host and interact as directly attached terminal users of that host.

**threshold.** (1) In IBM bridge programs, a value set for the maximum number of frames that are not forwarded across a bridge due to errors, before a "threshold exceeded" occurrence is counted and indicated to network management programs. (2) An initial value from which a counter is decremented to 0, or a value to which a counter is incremented or decremented from an initial value.

**throughput class.** In packet switching, the speed at which data terminal equipment (DTE) packets travel through the packet switching network.

**time to live (TTL).** A technique used by best-effort delivery protocols to inhibit endlessly looping packets. The packet is discarded if the TTL counter reaches 0.

**timeout.** (1) An event that occurs at the end of a predetermined period of time that began at the occurrence of another specified event. (I) (2) A time interval allotted for certain operations to occur; for example, response to polling or addressing before system operation is interrupted and must be restarted.

**TLV.** Type/Length/Value, a generalized information element in a LAN Emulation packet.

**token.** (1) In a local area network, the symbol of authority passed successively from one data station to another to indicate the station temporarily in control of the transmission medium. Each data station has an opportunity to acquire and use the token to control the medium. A token is a particular message or bit pattern that signifies permission to transmit. (T) (2) In LANs, a sequence of bits passed from one device to another along the transmission medium. When the token has data appended to it, it becomes a frame.

**token ring.** (1) According to IEEE 802.5, network technology that controls media access by passing a token (special packet or frame) between media-attached stations. (2) A FDDI or IEEE 802.5 network with a ring topology that passes tokens from one attaching ring station (node) to another. (3) See also *local area network (LAN)*.

**token-ring network.** (1) A ring network that allows unidirectional data transmission between data stations, by a token passing procedure, such that the transmitted data return to the transmitting station. (T) (2) A network that uses a ring topology, in which tokens are passed in a circuit from node to node. A node that is ready to

send can capture the token and insert data for transmission.

**topology.** In communications, the physical or logical arrangement of nodes in a network, especially the relationships among nodes and the links between them.

**topology database update (TDU).** A message about a new or changed link or node that is broadcast among APPN network nodes to maintain the network topology database, which is fully replicated in each network node. A TDU contains information that identifies the following:

- The sending node
- The node and link characteristics of various resources in the network
- The sequence number of the most recent update for each of the resources described.

**trace.** (1) A record of the execution of a computer program. It exhibits the sequences in which the instructions were executed. (A) (2) For data links, a record of the frames and bytes transmitted or received.

**transceiver (transmitter-receiver).** In LANs, a physical device that connects a host interface to a local area network, such as Ethernet. Ethernet transceivers contain electronics that apply signals to the cable and that sense collisions.

**Transmission Control Protocol (TCP).** A communications protocol used in the Internet and in any network that follows the U.S. Department of Defense standards for internetwork protocol. TCP provides a reliable host-to-host protocol between hosts in packet-switched communications networks and in interconnected systems of such networks. It uses the Internet Protocol (IP) as the underlying protocol.

**Transmission Control Protocol/Internet Protocol (TCP/IP).** A set of communications protocols that support peer-to-peer connectivity functions for both local and wide area networks.

**transmission group (TG).** (1) A connection between adjacent nodes that is identified by a transmission group number. (2) In a subarea network, a single link or a group of links between adjacent nodes. When a transmission group consists of a group of links, the links are viewed as a single logical link, and the transmission group is called a *multilink transmission group (MLTG)*. A *mixed-media multilink transmission group (MMMLTG)* is one that contains links of different medium types (for example, token-ring, switched SDLC, nonswitched

SDLC, and frame-relay links). (3) In an APPN network, a single link between adjacent nodes. (4) See also *parallel transmission groups*.

**transmission header (TH).** Control information, optionally followed by a basic information unit (BIU) or a BIU segment, that is created and used by path control to route message units and to control their flow within the network. See also *path information unit*.

**transparent bridging.** In LANs, a method for tying individual local area networks together through the medium access control (MAC) level. A transparent bridge stores the tables that contain MAC addresses so that frames seen by the bridge can be forwarded to another LAN if the tables indicate to do so.

**transport layer.** In the Open Systems Interconnection reference model, the layer that provides a reliable end-to-end data transfer service. There may be relay open systems in the path. (T) See also *Open Systems Interconnection reference model*.

**trap.** In the Simple Network Management Protocol (SNMP), a message sent by a managed node (agent function) to a management station to report an exception condition.

**tunneling.** To treat a transport network as though it were a single communication link or LAN. See also *encapsulation*.

**T1.** In the United States, a 1.544-Mbps public access line. It is available in twenty-four 64-Kbps channels. The European version (E1) transmits 2.048 Mbps. The Japanese version (J1) transmits 1.544 Mbps.

## U

**UNI.** User-Network Interface, the interface between user equipment and an ATM switch network.

**universally administered address.** In a local area network, the address permanently encoded in an adapter at the time of manufacture. All universally administered addresses are unique. Contrast with *locally administered address*.

**User Datagram Protocol (UDP).** In the Internet suite of protocols, a protocol that provides unreliable, connectionless datagram service. It enables an application program on one machine or process to send a datagram to an application program on another machine or process. UDP uses the Internet Protocol (IP) to deliver datagrams.

## V

**V.24.** In data communication, a specification of the CCITT that defines the list of definitions for interchange circuits between data terminal equipment (DTE) and data circuit-terminating equipment (DCE).

**V.25.** In data communication, a specification of the CCITT that defines the automatic answering equipment and parallel automatic calling equipment on the General Switched Telephone Network, including procedures for disabling of echo controlled devices for both manually and automatically established calls.

**V.35.** In data communication, a specification of the CCITT that defines the list of definitions for interchange circuits between data terminal equipment (DTE) and data circuit-terminating equipment (DCE) at various data rates.

**V.36.** In data communication, a specification of the CCITT that defines the list of definitions for interchange circuits between data terminal equipment (DTE) and data circuit-terminating equipment (DCE) at rates of 48, 56, 64, or 72 kilobits per second.

**VCC.** Virtual Channel Connection, a connection between parties.

**VINES.** Virtual NETWORKing System.

**virtual circuit.** (1) In packet switching, the facilities provided by a network that give the appearance to the user of an actual connection. (T) See also *data circuit*. Contrast with *physical circuit*. (2) A logical connection established between two DTEs.

**virtual link.** In Open Shortest Path First (OSPF), a point-to-point interface that connects border routers that are separated by a non-backbone transit area. Because area routers are part of the OSPF backbone, the virtual link connects the backbone. The virtual links ensure that the OSPF backbone does not become discontinuous.

**Virtual Local Area Network (VLAN).** A logical grouping of one or more LANs based on protocol and subnet and used to isolate network traffic within these groups.

**Virtual NETWORKing System (VINES).** The network operating system and network software from Banyan Systems, Inc. In a VINES network, virtual linking allows all devices and services to appear to be directly connected to each other, when they may actually be thousands of miles apart. See also *StreetTalk*.

**virtual route (VR).** (1) In SNA, either (a) a logical connection between two subarea nodes that is physically realized as a particular explicit route or (b) a

logical connection that is contained wholly within a subarea node for intranode sessions. A virtual route between distinct subarea nodes imposes a transmission priority on the underlying explicit route, provides flow control through virtual route pacing, and provides data integrity through sequence numbering of path information units (PIUs). (2) Contrast with *explicit route (ER)*. See also *path* and *route extension (REX)*.

## W

**wide area network (WAN).** (1) A network that provides communication services to a geographic area larger than that served by a local area network or a metropolitan area network, and that may use or provide public communication facilities. (T) (2) A data communication network designed to serve an area of hundreds or thousands of miles; for example, public and private packet-switching networks, and national telephone networks. (3) Contrast with *local area network (LAN)* and *metropolitan area network (MAN)*.

**wildcard character.** Synonym for *pattern-matching character*.

## X

**X.21.** An International Telegraph and Telephone Consultative Committee (CCITT) recommendation for a general-purpose interface between data terminal equipment and data circuit-terminating equipment for synchronous operations on a public data network.

**X.25.** (1) An International Telegraph and Telephone Consultative Committee (CCITT) recommendation for the interface between data terminal equipment and packet-switched data networks. (2) See also *packet switching*.

**Xerox Network Systems (XNS).** The suite of internet protocols developed by the Xerox Corporation. Although similar to TCP/IP protocols, XNS uses different packet formats and terminology. See also *Internetwork Packet Exchange (IPX)*.

## Z

**zone.** In AppleTalk networks, a subset of nodes within an internet.

**Zone Information Protocol (ZIP).** In AppleTalk networks, a protocol that provides zone management service by maintaining a mapping of the zone names and network numbers across the internet on the session layer.

**zone information table (ZIT).** A listing of network numbers and their associated zone name mappings in

the internet. This listing is maintained by each internet router in an AppleTalk internet.

---

# Index

## A

- accept-qos-parms-from-lecs
  - QoS parameter 16-5
- access
  - local connection 2-1
  - physical 2-1
  - remote connection 2-1
- access code of the Voice/Data/Fax Modem 4-4
- Add
  - ATM configuration command 19-4
  - ATM Virtual Interface configuration command 19-12
  - change management configuration command 7-4
  - CONFIG command 6-8
  - ELANs configuration command 23-20
  - ELS configuration command 11-8
  - LECS configuration command 23-15
  - LECS Policies configuration command 23-33
  - LES-BUS configuration command 23-4
  - MAC filtering update subcommand 14-9
  - Security for ELANs configuration command 23-36
- address registration in LAN emulation 18-11
- address resolution in LAN emulation 18-11
- addresses, entering
  - ATM 19-1
- addresses, SLIP 2-3
- ATM
  - how to enter addresses 19-1
- ATM addresses of LAN emulation components 18-4
- ATM addressing 18-3
- ATM addressing in IPX
- ATM configuration commands
  - accessing 19-2
  - add 19-4
  - ATM Virtual Interface 19-11
  - disable 19-8
  - enable 19-8
  - Exit 19-9
  - EXIT ATM Virtual Interface 19-11
  - Help 19-12
  - INTERFACE 19-4
  - LE-Client 19-3
  - LE-Services 19-3
  - list 19-4
  - LIST ATM Virtual Interface 19-11
  - qos 19-5
  - remove 19-5
  - REMOVE ATM Virtual Interface 19-11
  - set 19-5
  - summary 19-3
  - VIRTUAL ATM 19-3

- ATM console command
  - exit 20-2, 20-6
  - interface 20-2, 20-3
  - LE-Services 20-2
  - list 20-3
  - trace 20-4
  - wrap 20-5
- ATM console commands
  - accessing 20-1
  - summary 20-2
- ATM network interface
  - configuring 19-1
  - monitoring 20-1
- ATM Virtual Interface
  - ATM configuration command 19-11
- ATM Virtual Interface configuration commands
  - Add 19-12
  - Exit 19-13
  - List 19-12
  - Remove 19-12
  - summary 19-11
- Attach
  - MAC filtering configuration command 14-5

## B

- backup configuration 2-7
- bank for operational software images 2-8
- BCM 18-14
- benefits of LAN emulation 18-1
- Boot
  - CONFIG command 6-9
- Boot CONFIG
  - process
    - entering from CONFIG 6-9
- boot config, TFTP file transfer in 2-9
- boot configuration commands 2-8
- boot configuration database
  - displaying 7-9
- bridging
  - See routing and bridging
- Bridging features
  - MAC Filtering 14-4
  - update subcommands 14-3, 14-9
- bridging option of the Web browser interface 3-7
- Broadcast and Unknown Server 18-2
  - See also BUS
- Broadcast Manager 18-14
- Buffer
  - GWCON command 9-3
- BUS 18-2
  - connecting to 18-11

BUS (*continued*)  
  functions of 18-12  
BUS monitor 18-18

## C

### Change

- CONFIG command 6-9
- change management 2-8
  - changing file statuses 2-9
  - commands available from 7-2
  - copy command 2-11
  - describe load images 2-10
  - disable dumping 2-11
  - enable dumping 2-11
  - entering and exiting 7-2
  - exiting 7-13
  - managing software files 2-8
  - model 7-1
  - other functions 2-10
  - understanding 7-1
- change management configuration commands
  - ?(Help) 7-3
  - Add 7-4
  - Copy 7-5
  - Describe 7-6
  - Erase 7-7
  - Exit 7-13
  - List 7-9
  - Lock 7-10
  - Set 7-11
  - TFTP 7-12
  - Unlock 7-12
- Classical IP over ATM 18-5
- Clear
  - CONFIG command 6-12
  - ELS configuration command 11-8
  - ELS console command 12-7
  - GWCON command 9-4
  - MAC Filtering console command 15-2
- clock, setting and changing 6-25
- closing a telnet session 5-10
- command history 3-8, 5-6
- command line interface 2-4
- Commands
  - executing 1-4
- completing the configuration after quick configuration 2-7
- components of LAN emulation 18-2
- CONFIG
  - commands
    - change 6-9
    - summary of 6-7
- config as seen in change management 2-8
- CONFIG commands
  - add 6-8

### CONFIG commands (*continued*)

- Boot 6-9
- change 6-9
- Clear 6-12
- Delete 6-13
- Disable 6-14
- Enable 6-14
- Event 6-15
- Feature 6-15
- List 6-17
- Network 6-18
- Patch 6-19
- Protocol 6-20
- Qconfig 6-21
- Set 6-21
- summary 6-7
- system memory dump 6-16
- Time 6-25
- Unpatch 6-26
- Update 6-26

CONFIG process

- accessing 1-11
- commands available from 6-7
- definition 1-9
- description of 6-1
- entering 1-12, 6-6
- exiting 6-6

CONFIG-Only Mode

- description 6-2
- entering automatically 6-2
- manual entry 6-3

CONFIG-ONLY process

- definition 1-9
- use of 1-10

Configuration

- completing after quick configuration 2-7
- displaying information about 9-5
- file, backup 2-7
- GWCON command 9-4
- initial 2-6
- managing problems 2-7
- network interfaces 1-18
- quick 2-7
- tools 2-3
- updating memory 6-26

configuration and console menu of the Web browser interface 3-3

configuration and monitoring tools 2-3

Configuration command 1-14

- set prompt-level
  - add prefix to hostname 6-23

configuration files

- changing status 2-9
- managing 2-8
- managing using the Configuration Program 2-10
- status 2-8

- configuration files (*continued*)
  - viewing 2-8
- configuration option of the Voice/Data/Fax Modem 4-7
- configuration program
  - using to manage the configuration files 2-10
- configuration using the Voice/Data/Fax Modem 4-2
- configuration using the Web browser interface 3-4
- Configuring 7-2
  - change management
    - entering and exiting 7-2
  - summary 7-2
  - user access 6-5
- connecting to a process 1-5
- connecting to the BUS 18-11
- console access, local and remote 2-5
- console commands
  - LAN Emulation Client (LEC) 22-1
- console monitoring of the Web browser interface 3-4
- Copy
  - change management configuration command 7-5
- copy command in change management 2-11
- CPU
  - displaying memory usage of 9-10
- Create
  - ELAN console command 24-44
  - LAN Emulation Services console command 24-3
  - LECS console command 24-31
  - LECS Policies console command 24-40
  - LECS Security console command 24-55
  - MAC filtering configuration commands 14-5

## D

- data direct VCCs 18-13
- Data/Fax Modem 2-4
  - configuring 4-1
  - default settings 2-3
  - description 4-1
- Data/Fax Modem support 4-1
- database
  - LES-BUS console command 24-7
- date, setting and changing 6-25
- Default
  - ELS configuration command 11-8
  - MAC filtering configuration command 14-5
- default settings for the serial port and the Data/Fax Modem 2-3
- Delete
  - CONFIG command 6-13
  - ELAN console command 24-45
  - ELS configuration command 11-8
  - LECS console command 24-31
  - LECS Policies console command 24-41
  - LECS Security console command 24-55
  - LES-BUS console command 24-14
  - MAC filtering configuration command 14-6

- Delete (*continued*)
  - MAC filtering update subcommand 14-10
- Describe
  - change management configuration command 7-6
- describe load images 2-10
- description of OPCON 5-1
- description of the Data/Fax Modem 4-1
- Detach
  - MAC filtering configuration command 14-6
- device presence and status report of the Voice/Data/Fax Modem 4-7
- devices option of the Web browser interface 3-6
- Diags
  - OPCON command 5-4
- Disable
  - ATM configuration command 19-8
  - CONFIG command 6-14
  - GWCON command 9-6
  - LECS Policies configuration command 23-34
  - LES-BUS configuration command 23-5
  - LES-BUS console command 24-14
  - MAC filtering configuration command 14-6
  - MAC Filtering console command 15-2
  - Security for ELANs configuration command 23-36
- disable dumping 2-11
- Display
  - ELS configuration command 11-9
  - ELS console command 12-7
- display hostname 6-24
- display hostname software VPD 6-24
- display hostname with carriage return 6-24
- display hostname with changes 6-24
- display hostname with date 6-24
- display hostname with time 6-24
- displaying
  - boot configuration database 7-9
- Divert
  - OPCON command 5-5
- downloading files to the MSS Server 2-8
- dumping, disabling 2-11
- dumping, enabling 2-11
- duplicate policy values 18-9

## E

- ELAN console commands
  - create 24-44
  - delete 24-45
  - exit 24-46
  - list 24-45
  - select elan 24-45
  - statistics 24-46
  - summary of 24-44
- ELAN details console commands
  - exit 24-53
  - les 24-47

## ELAN details console commands (*continued*)

- list 24-50
- policy 24-50
- set 24-52
- summary of 24-47
- tlvs 24-52

## ELAN name policy 18-8

## ELAN type policy 18-9

## elans

- LECS configuration command 23-15
- LECS console command 24-31
- LECS Policies console command 24-41

## ELANs configuration commands

- add 23-20
- exit 23-22
- list 23-21
- remove 23-21
- select 23-21
- summary 23-20

## ELANs configuration commands, detailed

- exit 23-32
- les 23-23
- list 23-26
- policy 23-26
- set 23-28
- summary 23-23
- Tlv 23-29

## ELS

- capturing output using Telnet 12-2
- concepts of 11-3
- description of 11-1
- entering 6-15
- exiting to CONFIG prompt 11-16
- exiting to GWCON prompt 12-16
- how to use 12-1
- interpreting messages 11-3
- monitoring 12-1
- reloading 12-11
- setting up traps 12-2
- storing 12-12
- tracing 11-14, 12-12
- trapping 12-12, 12-15
- troubleshooting example 1 12-3
- troubleshooting example 2 12-3
- troubleshooting example 3 12-4
- using to troubleshoot 12-3

## ELS (event logging system) monitoring of the Web

- browser interface 3-4

## ELS Configuration

- entering and exiting 11-2

## ELS Configuration Commands

- ?(Help) 11-7
- Add 11-8
- Clear 11-8
- Default 11-8
- Delete 11-8

## ELS Configuration Commands (*continued*)

- Display 11-9
- Exit 11-16
- List 11-11
- Nodisplay 11-12
- Notrace 11-13
- Notrap 11-13
- Set 11-14
- summary of 11-7
- Trace 12-14
- Trap 11-15

## ELS Console Commands

- ?(Help) 12-6
- Clear 12-7
- Display 12-7
- Exit 12-16
- Files 12-8
- List 12-8
- Nodisplay 12-10
- Notrace 12-11
- Notrap 12-11
- Remove 12-11
- Restore 12-11
- Retrieve 12-11
- Save 12-12
- Set 12-12
- Statistics 12-13
- summary 12-6
- Trap 12-15
- View 12-15

## ELS Console Environment

- entering and exiting 12-5

## ELS messages

- explanation 11-5
- Groups 11-6
- logging level 11-4
- managing rotation 12-1
- network information 11-6
- suppressing display of 11-12
- suppressing display of (Nodisplay) 12-10
- suppressing tracing 12-11
- suppressing trapping 11-13
- suppressing trapping of (Notrap) 12-11
- Tracing 12-14
- Trapping 11-15

## Enable

- ATM configuration command 19-8
  - CONFIG command 6-14
  - LECS Policies configuration command 23-34
  - LES-BUS configuration command 23-5
  - LES-BUS console command 24-15, 24-16
  - MAC filtering configuration command 14-7
  - MAC Filtering console command 15-2
  - Security for ELANs configuration command 23-37
- enable dumping 2-11



- end system identifier 18-3
- Environment
  - GWCON command 9-7
- Erase
  - Change management configuration command 7-7
- Error
  - GWCON command 9-8
- ESI 18-3
- Ethernet configuration commands
  - IP-Encapsulation 21-7, 21-18
- Event
  - CONFIG command 6-15
  - GWCON command 9-8
- Event logging
  - subsystem 11-4
- event logging system monitoring of the Web browser interface 3-4
- event logs option of the Voice/Data/Fax Modem 4-7
- Event number parameter 11-4
- Events
  - Causes 11-3
- examples of initial configuration 2-6
- Exit
  - ATM configuration command 19-9
  - ATM console command 20-2, 20-6
  - ATM Virtual Interface configuration command 19-13
  - change management configuration command 7-13
  - ELAN console command 24-46
  - ELAN details console command 24-53
  - ELANs configuration command 23-22
  - ELANs detailed configuration command 23-32
  - ELS configuration command 11-16
  - ELS console command 12-16
  - LAN Emulation Services console command 24-5
  - LE Services configuration command 23-3
  - LECS configuration command 23-19
  - LECS console command 24-39
  - LECS Policies configuration command 23-35
  - LECS Policies console command 24-43
  - LECS Security console command 24-57
  - LES-BUS configuration command 23-14
  - LES-BUS console command 24-29
  - MAC filtering configuration command 14-8
  - MAC filtering console command 15-4
  - MAC filtering update subcommand 14-12
  - Security for ELANs configuration command 23-38
- Exiting
  - network interface configuration process 1-18
  - protocol configuration process 1-13
  - protocol console process 1-15
- exiting the interface console process 9-12
- Exiting the Router 1-7

## F

- fax accumulation 2-5
- FDDI (Fiber Distributed Data Interface)
  - configuring 13-1
- FDDI configuration commands 13-4
  - accessing 13-4
  - exit 13-7
  - frame 13-5
  - list 13-5
  - set 13-6
- FDDI console commands
  - accessing 13-7
  - exit 13-8
  - list 13-8
- Feature
  - CONFIG command 6-15
  - GWCON command 9-8
  - Quality of Service (QoS) 16-1
- Features
  - accessing configuration and console processes 1-15
  - bandwidth reservation 9-8
  - MAC filtering 6-15, 9-8, 14-1, 15-1
  - WAN restoral 9-8
  - WAN restoral/reroute 6-15
- Fiber Distributed Data Interface
  - See also* FDDI (Fiber Distributed Data Interface)
  - overview 13-1
  - protocols supported 13-1
- file statuses 7-9
- file transfer 2-5
- file transfer using TFTP 2-9
- Files
  - ELS console command 12-8
- files, changing status of 2-9
- Flow control
  - packets 9-4
- Flush
  - OPCON command 5-5
- forum-compliant LEC
  - configuring a specific client 21-5
- functions
  - brief overview 2-12
  - change management 2-8
  - file transfer 2-5
  - file transfer using TFTP 2-9
- functions of the BUS 18-12

## G

- Getting Help 1-6
- Group
  - deleting 11-8
- Group name parameter 11-6

- guided configuration using the Web browser interface 3-6

## GWCON

- process
  - entering 1-13

## GWCON commands

- ?(Help) 9-3
- buffer 9-3
- clear 9-4
- configuration 9-4
- disable 9-6
- Environment 9-7
- error 9-8
- event 9-8
- feature 9-8
- interface 9-9
- memory 9-10
- network 9-11
- protocol 9-12
- Queue 9-13
- statistics 9-14
- summary of 9-2
- test 9-14

## GWCON process

- definition 1-9
- description of 9-1
- entering and exiting 9-2

## H

### Halt

- OPCON command 5-6

### Help

- ATM configuration command 19-12
- change management configuration command 7-3
- console command 1-6
- ELS configuration command 11-7
- ELS console command 12-6
- GWCON command 9-3
- OPCON command 5-4

### Home Page Structure of the Web browser

- interface 3-2

- how to list the protocols 6-21

- HTML interface 3-1

## I

### IBM 8210

- Config-only mode 6-3

### IBM LAN Emulation Client

- configuring an Ethernet IBM client 21-15

- Identifying prompts 1-5

- ILMI functions in LAN emulation 18-5

- image of the operational software 2-8

- initial configuration 2-6

- examples 2-6

- installing the Voice/Data/Fax Modem 4-1

### Intercept

- OPCON command 5-6

- intercept character 1-6

- changing 5-6

### Interface

- ATM configuration command 19-4

- ATM console command 20-2, 20-3

- GWCON command 9-9

### Interface device

- adding 6-8

- changing 6-9

### Interim Local Management Interface

- See ILMI functions in LAN emulation

- IP option of the Web browser interface 3-7

### IP-Encapsulation

- Ethernet configuration command 21-7, 21-18

- IPX option of the Web browser interface 3-8

## K

- key parameters for LAN emulation 18-18

## L

- LAN destination policy (MAC address policy) 18-8

### LAN emulation

- address registration to the LES 18-11

- address resolution by the LES 18-11

- addressing in ATM 18-3

- ATM addresses of LAN emulation components 18-4

- ATM addressing for 18-3

- benefits 18-1

- broadcast and unknown server (BUS) 18-2

- Broadcast Manager (BCM) 18-14

- BUS 18-2

- BUS monitor 18-18

- client 18-2

- components 18-2

- components, ATM addresses of 18-4

- configuration of the signaling version 18-5

- configuration server 18-2

- configuration server, policies and policy values 18-7

- connecting to the BUS 18-11

- connecting to the LES 18-10

- ELAN name policy 18-8

- ELAN type policy 18-9

- establishing data direct VCCs 18-13

- functions of the BUS 18-12

- ILMI functions, related 18-5

- key configuration parameters 18-18

- LAN emulation configuration server, overview of 18-6

- LECS duplicate policy values 18-9

- LECS LAN destination policy (MAC address policy) 18-8

LAN emulation (*continued*)

- LECS TLVs 18-10
- LECS, overview of 18-6
- LECS, policies and policy values 18-7
- locating the LECS using ILMI 18-5
- max frame size policy 18-9
- overview 18-1
- overview of related ILMI functions 18-5
- overview of server extensions for LAN emulation 18-13
- redundancy 18-15
- reliability 18-15
- sample assignment policies for LECS 18-8
- security 18-17
- server 18-2
- signaling version 18-5

LAN Emulation Client (LEC)

- monitoring 22-1

LAN Emulation Client Environment

LAN emulation configuration server

- See LECS

LAN emulation option of the Web browser interface 3-6

LAN emulation server

- See LES

LAN Emulation Services

- components 23-1
- configuration 23-1
- configuration command 23-2
- lecs command 23-2
- les-bus command 23-2
- monitoring 24-1

LAN Emulation Services console commands

- accessing 24-2
- create 24-3
- exit 24-5
- lecs 24-4
- list 24-4
- security 24-4
- summary 24-3
- work 24-4

LE client 18-2

LE Services configuration command

- exit 23-3
- list 23-3
- rename 23-3
- security 23-3

LE-Client 17-1

- ATM configuration command 19-3
- QoS console command 17-1

LE-Services

- ATM configuration command 19-3
- ATM console command 20-2

LEC console commands

- accessing 22-1
- list 22-2

LEC console commands (*continued*)

- mib 22-5
- summary of 22-2

LECS 18-2, 18-6

- component of LAN emulation 18-6
- duplicate policy values 18-9
- ELAN name policy 18-8
- ELAN type policy 18-9
- LAN destination policy (MAC address policy) 18-8
- LAN Emulation Services console command 24-4
- LE Services configuration command 23-2
- max frame size policy 18-9
- sample assignment policies 18-8
- TLVs 18-10

LECS configuration commands

- add 23-15
- elans 23-15
- Exit 23-19
- list 23-16
- policies 23-16
- remove 23-16
- search 23-17
- set 23-17
- summary 23-15

LECS console commands

- create 24-31
- delete 24-31
- elans 24-31
- exit 24-39
- list 24-31
- memory 24-34
- policies 24-34
- restart 24-34
- search 24-34
- set 24-36
- statistics 24-38
- summary of 24-30

LECS Policies configuration commands

- add 23-33
- disable 23-34
- enable 23-34
- exit 23-35
- list 23-34
- remove 23-35
- summary 23-33

LECS Policies console commands

- create 24-40
- delete 24-41
- Elans 24-41
- exit 24-43
- list 24-41
- Memory 24-42
- Policies 24-42
- Restart 24-42
- Search 24-42
- Set 24-42

## LECS Policies console commands *(continued)*

- statistics 24-42
- summary of 24-40

## LECS Security console commands

- create 24-55
- delete 24-55
- exit 24-57
- list 24-55
- restart 24-56
- statistics 24-57
- summary of 24-54

## LES 18-2

- address registration 18-11
- address resolution 18-11
- connecting to 18-10
- ELAN details console command 24-47
- ELANs detailed configuration command 23-23

## les-bus

- LE Services configuration command 23-2

## LES-BUS configuration command

- add 23-4
- disable 23-5
- enable 23-5
- exit 23-14
- list 23-6
- remove 23-7
- set 23-8
- set bus-mode 23-9
- summary 23-4

## LES-BUS console commands

- database 24-7
- delete 24-14
- disable 24-14
- enable 24-15, 24-16
- exit 24-29
- restart 24-18
- set 24-18
- statistics 24-20
- stop 24-29
- summary of 24-6

## List

- ATM configuration command 19-4
- ATM console command 20-3
- ATM Virtual Interface configuration command 19-12
- change management configuration command 7-9
- CONFIG command 6-17
- ELAN console command 24-45
- ELAN details console command 24-50
- ELANs configuration command 23-21
- ELANs detailed configuration command 23-26
- ELS configuration command 11-11
- ELS console command 12-8
- LAN Emulation Services console command 24-4
- LE Client QoS configuration commands 16-8
- LE Services configuration command 23-3
- LEC console command 22-2

## List *(continued)*

- LECS configuration command 23-16
- LECS console command 24-31
- LECS Policies configuration command 23-34
- LECS Policies console command 24-41
- LECS Security console command 24-55
- LES-BUS configuration command 23-6
- MAC filtering configuration command 14-7
- MAC Filtering console command 15-3
- MAC filtering update subcommand 14-11
- Security for ELANs configuration command 23-37
- List configuration command 1-12
- List Devices command 1-18, 19-2, 24-2
- listing the configuration 6-21
- Local consoles 1-2
- Local terminals 1-2
- locating the LECS using ILMI 18-5
- Lock
  - change management configuration command 7-10
- lock command in change management 2-11
- Logging in
  - from local console 1-3
  - from remote console 1-3
  - remote login name 1-3
- Login
  - disabling 6-14
  - enabling 6-14
- Logout
  - OPCON command 5-7

## **M**

MAC address policy (LAN destination policy) 18-8

## MAC filtering

- accessing the configuration prompt 14-3
- accessing the console prompt 15-1
- discussion 14-1
- monitoring 15-1
- parameters 14-1
- sliding-window parameters 14-1
- update subcommands 14-3
- using tags 14-3

## MAC Filtering configuration commands

- accessing 14-3
- attach 14-5
- create 14-5
- default 14-5
- delete 14-6
- detach 14-6
- disable 14-6
- enable 14-7
- exit 14-8
- list 14-7
- MAC filtering configuration command 14-8
- move 14-8
- reinit 14-8

- MAC Filtering configuration commands (*continued*)
    - set-cache 14-8
    - summary 14-4
    - update 14-8
    - update subcommands 14-3
  - MAC Filtering configuration subcommands
    - update subcommands
      - Add 14-9
      - delete 14-10
      - exit 14-12
      - list 14-11
      - move 14-12
      - set-action 14-12
      - summary 14-9
  - MAC filtering console commands
    - accessing 15-1
    - clear 15-2
    - disable 15-2
    - enable 15-2
    - exit 15-4
    - list 15-3
    - reinit 15-3
    - summary 15-1
  - maintenance log configuration parameter of the
    - Voice/Data/Fax Modem 4-4
  - managing configuration problems 2-7
  - managing software files 2-8
  - max frame size policy 18-7, 18-9
  - max-burst-size
    - QoS parameter 16-4
  - max-reserved-bandwidth
    - QoS parameter 16-2
  - Memory
    - displaying information about 9-10
    - erasing information 12-11
    - GWCON command 9-10
    - LECS console command 24-34
    - LECS Policies console command 24-42
    - obtaining information about 5-7
    - OPCON command 5-7
  - menu items of the Voice/Data/Fax Modem 4-4
  - menu, configuration and console of the Web browser
    - interface 3-3
  - Messages
    - explanation 11-5
    - interpreting 11-3
    - receiving 10-2
  - mib
    - LEC console command 22-5
  - Modem
    - disabling 6-14
    - enabling 6-14
  - Monitoring
    - ATM 20-1
    - network interfaces 1-19
  - monitoring, console of the Web browser interface 3-4
  - monitoring, event logging system of the Web browser
    - interface 3-4
  - MONITR process
    - commands affecting 10-2
    - definition 1-9
    - description of 10-1
    - entering and exiting 10-2
    - OPCON commands 10-2
    - receiving messages 10-2
  - MOSDDT process
    - definition 1-9
  - Move
    - MAC filtering configuration command 14-8
    - MAC filtering update subcommand 14-12
  - Multiprotocol Switched Services Configuration
    - Program 2-3
    - See also* configuration program
- ## N
- negotiate-qos
    - QoS parameter 16-5
  - Network
    - CONFIG command 6-18
    - environment 6-18, 9-11
    - GWCON command 9-11
  - Network command 1-18, 19-2, 22-1
  - Network interface
    - accessing configuration process 1-16
    - accessing console process 1-18
    - configuring 1-16
    - console process 1-16
    - deleting 6-13
    - disabling 9-6
    - displaying information about 6-17, 9-5, 9-9
    - enabling 9-14
    - exiting configuration 1-18
    - exiting console process 1-19
    - monitoring 1-19
    - supported interfaces 1-18
    - verifying 9-14
  - network monitoring using the Voice/Data/Fax
    - Modem 4-2
  - Network software
    - displaying statistical information about 9-14
  - Nodisplay
    - ELS configuration command 11-12
    - ELS console command 12-10
  - non-volatile configuration memory
    - replacing 6-9
  - Notrace
    - ELS configuration command 11-13
    - ELS console command 12-11
  - Notrap
    - ELS configuration command 11-13

Notrap (*continued*)  
ELS console command 12-11

## O

obtaining status of telnet session 5-10

OPCON commands

- ? (Help) 5-4
- diags 5-4
- divert 5-5
- flush 5-5
- halt 5-6
- intercept 5-6
- logout 5-7
- memory 5-7
- reload 5-8
- status 5-8
- summary of 5-3
- talk 5-9
- telnet 5-9

OPCON process

- accessing 5-2
- commands available from 5-3
- definition 1-9
- description 5-1
- getting back to 1-6
- summary 1-10, 1-11

operational software files 2-5, 18-1, 18-14

- changing status 2-9
- managing 2-8
- status 2-8
- viewing 2-8

other change management functions 2-10

Output

- discarding 5-5
- sending to other consoles 5-5
- suspending 5-6

overview of LAN emulation 18-1

overview of the functions 2-12

## P

Packet completion codes 11-5

Packet Forwarder

- entering CONFIG environment for 6-20

parameter descriptor entries

- QoS 17-4

Parameters

- configuring 6-21
- event number 11-4
- MAC filtering 14-1

parameters, key configuration

- for LAN emulation 18-18

Passwords 1-3

Patch

- CONFIG command 6-19

PCMCIA modem 2-1, 2-4, 2-5, 3-1, 3-2, 4-1

peak-cell-rate

- QoS parameter 16-3

physical access to the MSS Server 2-1

Pin parameter

- setting 11-14

policies

- agreement of 18-7
- LECS configuration command 23-16
- LECS console command 24-34
- LECS Policies console command 24-42

policies and policy values 18-7

policy

- ELAN details console command 24-50
- ELANs detailed configuration command 23-26

port

- See serial port

problems in configuration 2-7

prompt-level

- additional functions of

- display hostname with carriage return 6-24
- display hostname with changes 6-24
- display hostname with date 6-24
- display hostname with time 6-24
- display hostname with VPD 6-24

- configuration command

- add prefix to hostname 6-23
- display hostname 6-24

Prompts

- CONFIG 1-5
- GWCON 1-5
- identifying 1-5
- OPCON 1-5
- router processes 1-5

Protocol

- CONFIG command 6-20
- configuration process 1-11
- console process 1-11
- entering configuration process 1-12
- exiting configuration process 1-13
- GWCON command 9-12
- IDs 1-15
- names and numbers 1-15
- summary 1-15

Protocol command 1-12, 1-14

Protocol console process

- entering 1-14
- exiting 1-15

Protocols

- console process 1-13
- displaying information about 9-5
- entering configuration environment for 6-20
- entering console process 1-14
- exiting console process 1-15
- protocols, generating a list of the 6-21

## Q

- Qconfig
  - CONFIG command 6-21
- QoS
  - accept-qos-parms-from-lecs 16-5
  - accessing configuration prompt 16-6
  - accessing console commands 17-1
  - ATM configuration command 19-5
  - ATM Interface configuration commands
    - Remove 16-12, 16-14
    - Set 16-12
  - benefits 16-1
  - configuration commands 16-7
  - configuration parameters 16-2
  - configuration-parameters 17-3
  - configuring 16-1
  - console commands
    - LE-Client 17-1
  - console commands summary 17-1
  - LE Client configuration commands
    - List 16-8
    - Remove 16-11
    - Set 16-8
  - LE Client configuration commands, summary 16-7
  - LE-Client QoS console command summary 17-2
  - LE-Client QoS console commands
    - List 17-2
  - LEC Data Direct VCCs 17-4
  - LEC VCC table 17-4
  - max-burst-size parameter 16-4
  - max-reserved-bandwidth parameter 16-2
  - monitoring 17-1
  - negotiate-qos 16-5
  - parameter descriptor entries 17-4
  - peak-cell-rate parameter 16-3
  - qos-class parameter 16-4
  - statistics 17-5
  - sustained-cell-rate parameter 16-3
  - traffic 17-3
  - traffic-type parameter 16-3
  - validate-pcr-of-best-effort-vccs 16-5
- qos-class
  - QoS parameter 16-4
- Quality of Service
  - See QoS
- Queue
  - GWCON command 9-13
- QUICK CONFIG
  - definition 1-9
- quick configuration 2-7
  - description 6-3
  - manual entry 6-4
- Quick Configuration Process 1-10, 1-12
- quick configuration using the Web browser interface 3-5

## R

- redundancy of LAN emulation servers 18-15
- Reinit
  - MAC filtering configuration command 14-8
  - MAC filtering console command 15-3
- reliability of LAN emulation 18-15
- Reload 2-8
  - OPCON command 1-18, 5-8
- Reloading
  - router 1-18
- reloading the router 1-13
- remote connection 2-1
  - local connection 2-1
- Remote consoles 1-3
- Remote login 1-3
- remote service using the Voice/Data/Fax Modem 4-2
- Remote terminals 1-3
- remote voice access 2-5
- Remove
  - ATM configuration command 19-5
  - ATM Interface QoS configuration commands 16-12, 16-14
  - ATM Virtual Interface configuration command 19-12
  - ELANs configuration command 23-21
  - ELS console command 12-11
  - LE Client QoS configuration commands 16-11
  - LECS configuration command 23-16
  - LECS Policies configuration command 23-35
  - LES-BUS configuration command 23-7
  - Security for ELANs configuration command 23-37
- rename
  - LE Services configuration command 23-3
- reports option of the Voice/Data/Fax Modem 4-6
- resend last Fax report option of the Voice/Data/Fax Modem 4-8
- reset option of the Voice/Data/Fax Modem 4-5
- resetting the MSS Server 2-8
- restart 2-8
  - LECS console command 24-34
  - LECS Policies console command 24-42
  - LECS Security console command 24-56
  - LES-BUS console command 24-18
- restarting the router 6-21
- Restore
  - ELS console command 12-11
- Retrieve
  - ELS console command 12-11
- RFC 1483 19-6
- RFCs 6-25, 19-11
- ROPCON process
  - definition 1-9
- Route descriptor policy 18-7
- Router
  - deleting configuration information 6-12
  - displaying information about 6-17

- Router (*continued*)
  - rebooting 5-8
  - reloading 1-13, 1-18
- Router consoles
  - local 1-2
  - remote 1-3
  - using 1-2
- Router interface
  - communicating with processes 1-11
  - list of processes 1-7
  - user 1-7
- Router processes
  - attaching to 5-9
  - communicating with 1-7
  - connecting to 1-5
  - displaying information about 5-8
  - list of 1-7
- Router software
  - communicating with 9-12
  - reloading 5-8
  - user interface 1-2, 1-7
- Router Software Processes
  - summary 1-15
- Routers
  - exiting 1-7
- routing and bridging 21-1
- rules for using the Web browser interface 3-1

## S

- Save
  - ELS console commands 12-12
- search
  - LECS configuration command 23-17
  - LECS console command 24-34
  - LECS Policies console command 24-42
- security
  - LAN Emulation Services console command 24-4
  - LE Services configuration command 23-3
- Security for ELANs configuration commands
  - add 23-36
  - disable 23-36
  - enable 23-37
  - exit 23-38
  - list 23-37
  - remove 23-37
  - set 23-37
  - summary 23-36
- security of LAN emulation 18-17
- select
  - ELANs configuration command 23-21
- select elan
  - ELAN console command 24-45
- selector 18-3
- serial port 8-1, 18-20
  - default settings 2-3

- server extensions for LAN emulation 18-13
- servicing the MSS Server remotely, using the Voice/Data/Fax Modem 4-2
- Session
  - terminating 5-7
- Set
  - ATM configuration command 19-5
  - ATM Interface QoS configuration commands 16-12
  - change management configuration command 7-11
  - CONFIG command 6-21
  - ELAN details console command 24-52
  - ELANs detailed configuration command 23-28
  - ELS configuration command 11-14
  - ELS console command 12-12
  - LE Client QoS configuration commands 16-8
  - LECS configuration command 23-17
  - LECS console command 24-36
  - LECS Policies console command 24-42
  - LES-BUS configuration command 23-8
  - LES-BUS console command 24-18
  - Security for ELANs configuration command 23-37
- set bus-mode
  - LES-BUS configuration command 23-9
- Set Password command 1-3
- Set-action
  - MAC filtering update subcommand 14-12
- setting and changing time, date, and clock 6-25
- setup of the Web browser interface 3-1
- signaling version configuration in LAN emulation 18-5
- sliding-window filter
  - parameters 14-1
- SLIP addresses 2-3
- SNMP management 6-21
- Software Processes
  - summary 1-15
- SRAM device records
  - recreating 6-8
- Statistical information
  - clearing 9-4
- Statistics
  - ELAN console command 24-46
  - ELS console command 12-13
  - GWCON command 9-14
  - LECS console command 24-38
  - LECS Policies console command 24-42
  - LECS Security console command 24-57
  - LES-BUS console command 24-20
  - QoS 17-5
- Status
  - OPCON command 5-8
- status and statistics option of the Voice/Data/Fax Modem 4-5
- Status command 1-13, 1-16
- stop
  - LES-BUS console command 24-29



- sustained-cell-rate
  - QoS parameter 16-3
- system memory dump
  - CONFIG command 6-16

## T

- Talk
  - OPCON command 1-17, 5-9
- TASKER process
  - definition 1-9
- Technical Support Access 6-5
- Telnet
  - closing a connection 5-10
  - obtaining status of Telnet session 5-10
  - OPCON command 5-9
  - quitting a session 5-10
- Telnet command 5-10
- Telnet connections 1-3
  - closing 5-10
  - obtaining status of 5-10
- Temperature thresholds 9-7
- Test
  - GWCON command 9-14
- TFTP
  - change management configuration command 7-12
  - description of
    - related to change management 7-1
- TFTP for file transfer 2-9
- thermal shutdown mode configuration 4-7
- Time
  - CONFIG command 6-25
  - setting and changing 6-25
- Tlv
  - ELANs detailed configuration command 23-29
- TLVs 18-10
  - ELAN details console command 24-52
- tools for configuration and monitoring 2-3
- Trace
  - ATM console command 20-4
  - ELS configuration commands 12-14
- traffic-type
  - QoS parameter 16-3
- Trap
  - ELS configuration commands 11-15
  - ELS console command 12-15
- type length values
  - See LECS, TLVs

## U

- Unlock
  - change management configuration command 7-12
- unlock command in change management 2-12
- Unpatch
  - CONFIG command 6-26

- Update
  - CONFIG command 6-26
  - MAC filtering configuration command 14-8
- Update subcommands
  - MAC Filtering configuration command 14-3
- User access
  - adding user 6-8
  - changing password 6-11
  - changing user 6-12
  - configuring 6-5
  - deleting user 6-13
- User interface
  - processes 1-7
  - router software 1-7
- using the World Wide Web interface 3-1

## V

- validate pcr-of-best-effort-vccs
  - QoS parameter 16-5
- View
  - ELS console command 12-15
- virtual ATM
  - ATM configuration command 19-3
- voice access using the Voice/Data/Fax Modem 4-1
- voice pager configuration parameters of the Voice/Data/Fax Modem 4-3
- voice pager messages 4-4
- voice pager support using the Voice/Data/Fax Modem 4-2
- Voice/Data/Fax Modem 2-4
  - access code 4-4
  - configuration option 4-7
  - configuration using 4-2
  - configuring 4-1
  - device presence and status report 4-7
  - event logs 4-7
  - installation 4-1
  - maintenance log configuration parameter 4-4
  - menu items 4-4
  - network monitoring using 4-2
  - remote service using 4-2
  - reports option 4-6
  - resend last Fax report 4-8
  - reset option 4-5
  - status and statistics option 4-5
  - voice access using 4-1
  - voice pager configuration parameters 4-3
  - voice pager messages 4-4
  - voice pager support 4-2
- Voice/Data/Fax Modem support 4-1

## W

- Web browser interface 2-3, 3-1
  - bridging option 3-7

Web browser interface (*continued*)  
configuration 3-4  
configuration and console menu 3-3  
console monitoring 3-4  
devices option 3-6  
event logging system monitoring 3-4  
guided configuration 3-6  
IP option 3-7  
IPX option 3-8  
LAN emulation option 3-6  
quick configuration 3-5  
rules for using 3-1  
setup 3-1  
structure of the Home Page 3-2  
work  
  LAN Emulation Services console command 24-4  
world wide web interface 3-1  
wrap  
  ATM console command 20-5

---

# Tell Us What You Think!

**Multiprotocol Switched Services (MSS) Server  
Command Line Interface Volume 1  
User's Guide and Protocol Reference  
Publication No. SC30-3818-01**

We hope you find this publication useful, readable, and technically accurate, but only you can tell us! Your comments and suggestions will help us improve our technical publications. Please take a few minutes to let us know what you think by completing this form. If you are in the U.S.A., you can mail this form postage free or fax it to us at 1-800-253-3520. Elsewhere, your local IBM branch office or representative will forward your comments or you may mail them directly to us.

Overall, how satisfied are you with the information in this book?	Satisfied	Dissatisfied
	<input type="checkbox"/>	<input type="checkbox"/>

How satisfied are you that the information in this book is:	Satisfied	Dissatisfied
Accurate	<input type="checkbox"/>	<input type="checkbox"/>
Complete	<input type="checkbox"/>	<input type="checkbox"/>
Easy to find	<input type="checkbox"/>	<input type="checkbox"/>
Easy to understand	<input type="checkbox"/>	<input type="checkbox"/>
Well organized	<input type="checkbox"/>	<input type="checkbox"/>
Applicable to your task	<input type="checkbox"/>	<input type="checkbox"/>

Specific comments or problems:

---

---

---

Please tell us how we can improve this book:

---

---

---

Thank you for your comments. If you would like a reply, provide the necessary information below.

\_\_\_\_\_  
Name

\_\_\_\_\_  
Address

\_\_\_\_\_  
Company or Organization

\_\_\_\_\_  
Phone No.



Fold and Tape

Please do not staple

Fold and Tape



NO POSTAGE  
NECESSARY  
IF MAILED IN THE  
UNITED STATES

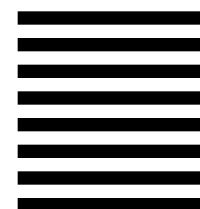

# BUSINESS REPLY MAIL

FIRST-CLASS MAIL PERMIT NO. 40 ARMONK, NEW YORK

POSTAGE WILL BE PAID BY ADDRESSEE

Design & Information Development  
Dept. CGF/Bldg. 656  
International Business Machines Corporation  
PO BOX 12195  
RESEARCH TRIANGLE PARK NC 27709-9990



Fold and Tape

Please do not staple

Fold and Tape





Printed in USA

---

The server Library

GA27-4140	<i>IBM 8210 Nways Multiprotocol Switched Services (MSS) Server Setup and Problem Determination Guide</i>
GX27-4017	<i>IBM 8210 Nways Multiprotocol Switched Services (MSS) Server Operations Reference Card</i>
SC30-3821	<i>IBM Multiprotocol Switched Services (MSS) Server Configuration and Operations Guide</i>
GX27-4018	<i>IBM Nways Multiprotocol Switched Services (MSS) Server Module Reference Card</i>
GA27-4141	<i>IBM Nways Multiprotocol Switched Services (MSS) Server Module Setup and Problem Determination Guide</i>
GC30-3820	<i>IBM Multiprotocol Switched Services (MSS) Server Introduction and Planning Guide</i>
SC30-3818	<i>IBM Multiprotocol Switched Services (MSS) Server Command Line Interface Volume 1: User's Guide and Protocol Reference</i>
SC30-3819	<i>IBM Multiprotocol Switched Services (MSS) Server Command Line Interface Volume 2: User's Guide and Protocol Reference</i>
SC30-3682	<i>Event Logging System Messages Guide</i>
GY27-0354	<i>IBM 8210 Nways Multiprotocol Switched Services (MSS) Server Service Manual</i>

SC30-3818-01

